



ITEM#: 789-BR61



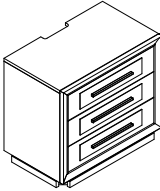
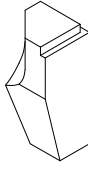
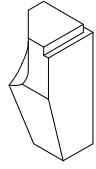

**DESCRIPTION: 3 DRAWER NIGHT STAND
W/ CHARGING STATION**

Thank you for purchasing this quality product. Be sure to check all packing material carefully for small parts, which may have come loose inside the carton during shipment. Identify and count all parts and compare with the parts list below.

PARTS LIST:

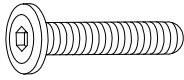
 <p>① Nightstand: 1pc</p>	 <p>② Front Leg (Leveler): 2pcs</p>	 <p>③ Back Leg (Nail): 2pcs</p>
--	---	--

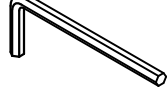
HARDWARE LIST

 <p>Ⓐ Bolt (Ø5/16"-18*50mm): 8pcs</p>	 <p>Ⓑ Spring Washer Ø5/16"*Ø13mm: 8pcs</p>	 <p>Ⓒ Flat Washer Ø5/16"*Ø19mm: 8pcs</p>	 <p>Ⓓ Allen Key 4mm: 1pc</p>	 <p>Ⓔ Tipping Restraint: 1pc</p>
--	---	---	---	---

STEP 1

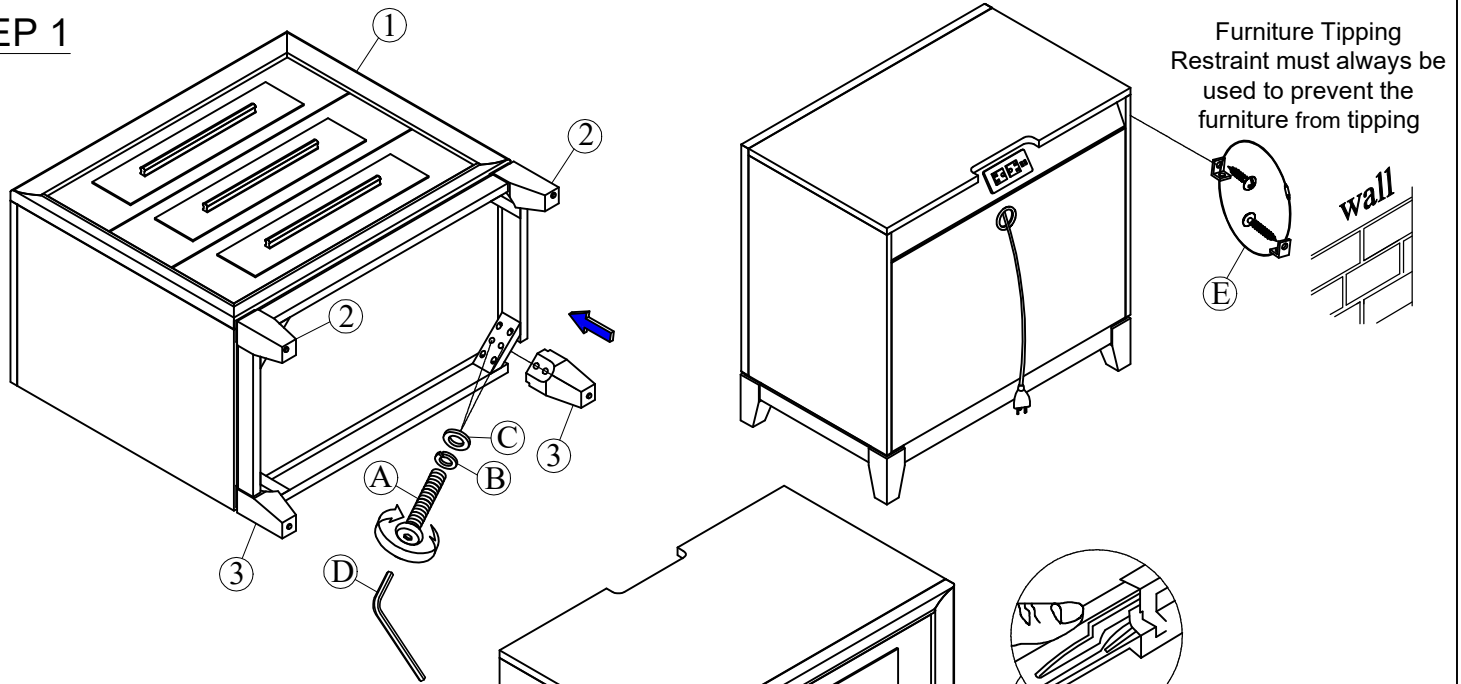

STEP 2

