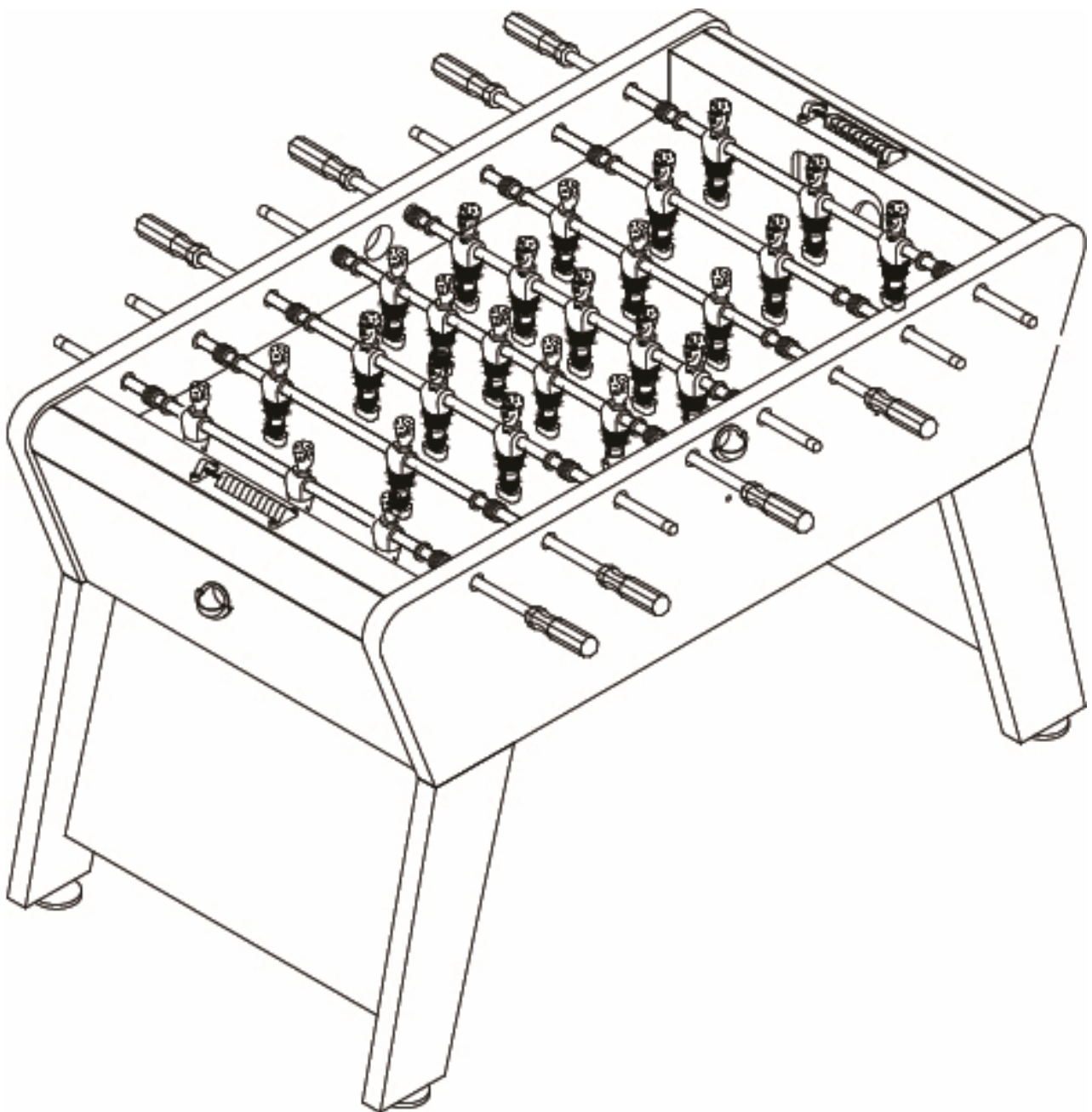


# SOCCER TABLE

## ASSEMBLY INSTRUCTIONS

### GT23025

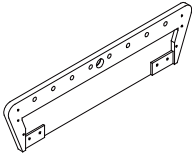
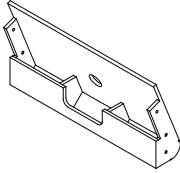
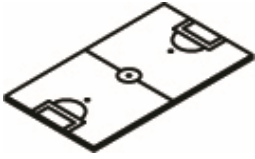
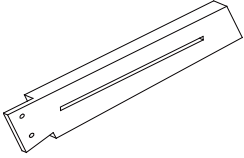
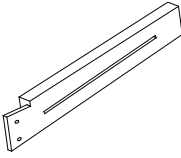
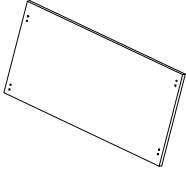
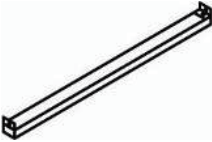


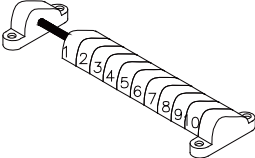


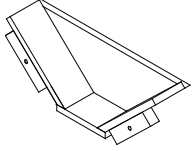


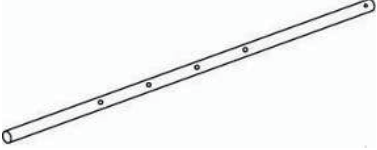




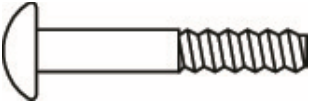






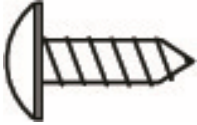

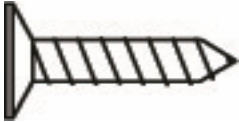
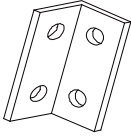



Missing parts, damages, and any other problems, please contact us via email.



[raykeepgoods@outlook.com](mailto:raykeepgoods@outlook.com)

# PART LIST

 <p><b>P1: SIDE PANEL</b> X 2</p>	 <p><b>P2: END PANEL</b> X 2</p>	 <p><b>P3: PLAYING FIELD</b> X 1</p>
 <p><b>P4A: LEGS</b> X 2</p>	 <p><b>P4B: LEGS</b> X 2</p>	 <p><b>P5: LEG PANELS</b> X 2</p>
 <p><b>P6: FIELD SUPPORT</b> X 2</p>	 <p><b>P7: BALL CATCHER</b> X 2</p>	 <p><b>P8: BALL ENTRY CUP</b> X 2</p>
 <p><b>P9: SLIDE SCORER</b> X 2</p>	 <p><b>P10: HANDLE</b> X 8</p>	 <p><b>P11: ROD CAP</b> X 8</p>
 <p><b>P12: GOAL BOX</b> X 2</p>	 <p><b>C1: 1 OR 3 PLAYER ROD</b> X 4</p>	 <p><b>C2: 2 PLAYER ROD</b> X 2</p>
 <p><b>C3: 5 PLAYER ROD</b> X 2</p>	 <p><b>C4: RUBBER BUSHING</b> X 16</p>	 <p><b>C5: PLASTIC ROD WASHER</b> X 16</p>

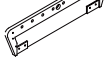



 <p><b>C6:PLAYER SCREW</b> X 26</p>	 <p><b>C7:PLAYER NUT</b> X 26</p>	 <p><b>C8:HOME PLAYER</b> X13</p>
 <p><b>C9:WAY PLAYER</b> X13</p>	 <p><b>H1:1/4*1" BOLT</b> X 20</p>	 <p><b>H2: WASHER</b> X 20</p>
 <p><b>H3:SCREW DRIVER</b> X 1</p>	 <p><b>H4 4*12mm SCREW</b> X 48</p>	 <p><b>H5: 3*25mm SCREW</b> X 26</p>
 <p><b>H6: 3*15mm SCREW</b> X 8</p>	 <p><b>H7: BRACKET</b> X 12</p>	 <p><b>H8: SOCCER BALL</b> X 2</p>
 <p><b>H9:LEG LEVELER</b> X 4</p>	 <p><b>H10: 3*35mm SCREW</b> X 4</p>	

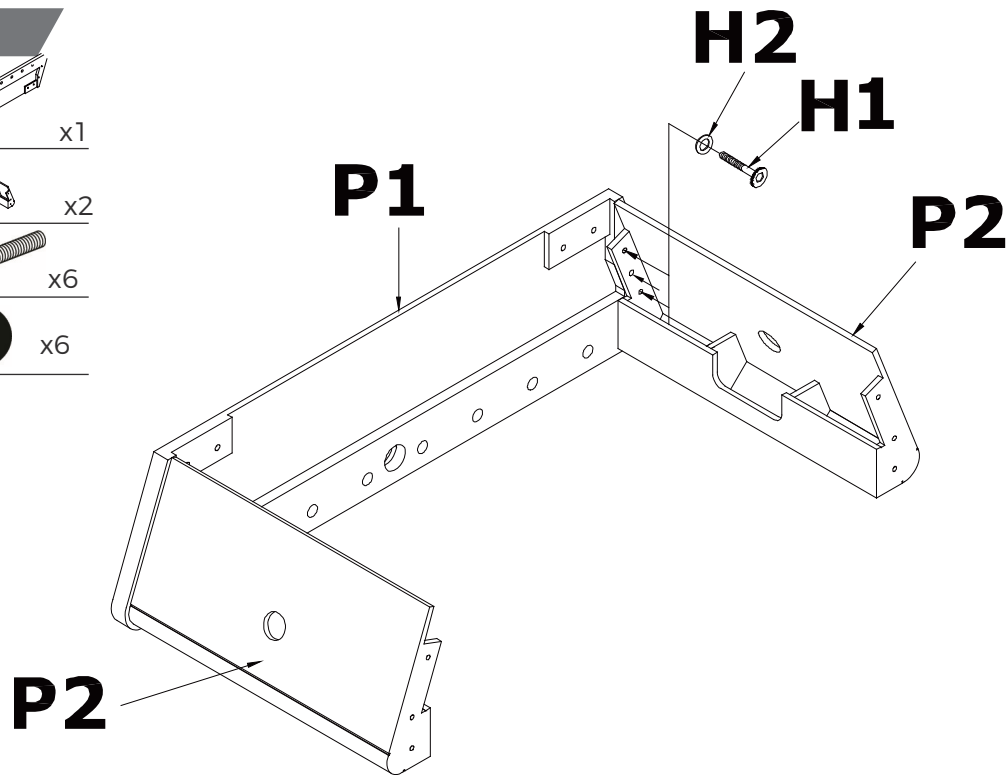
**WARNING : TWO ADULTS NEEDED TO ASSEMBLE SOCCER TABLE**

## **STEP 1**

Use H1 and H2 to attach P1 (1pc) side panel.

**FIG. 1**

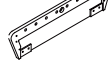
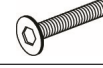


-  P1 x1
-  P2 x2
-  H1 x6
-  H2 x6

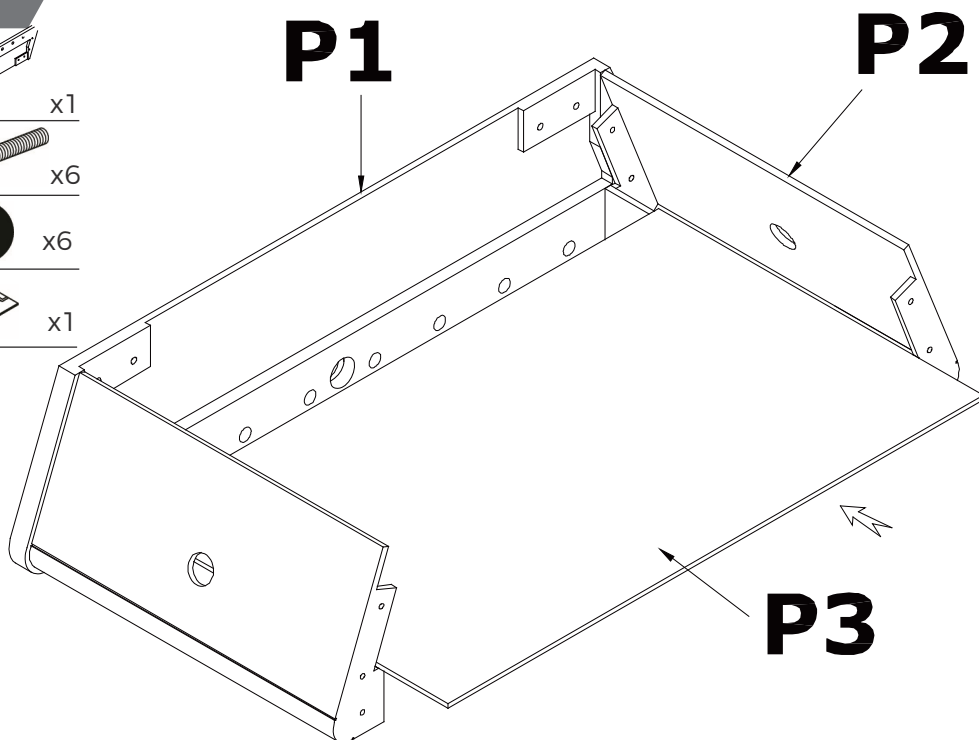


## **STEP 2**

Put P3 inside and use H1 and H2 to attach another P1 side panel.

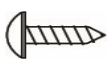
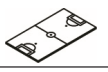
**FIG. 2**

-  P1 x1
-  H1 x6
-  H2 x6
-  P3 x1



# STEP 3

FIG. 3

- H5  x18
- P3  x1

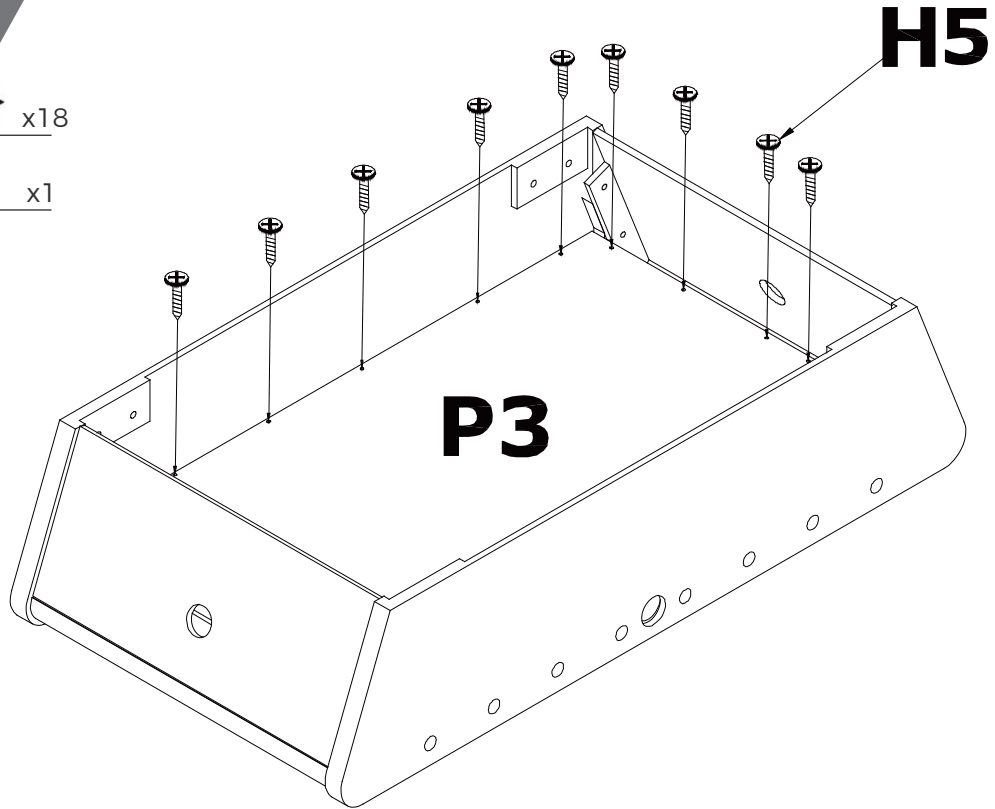





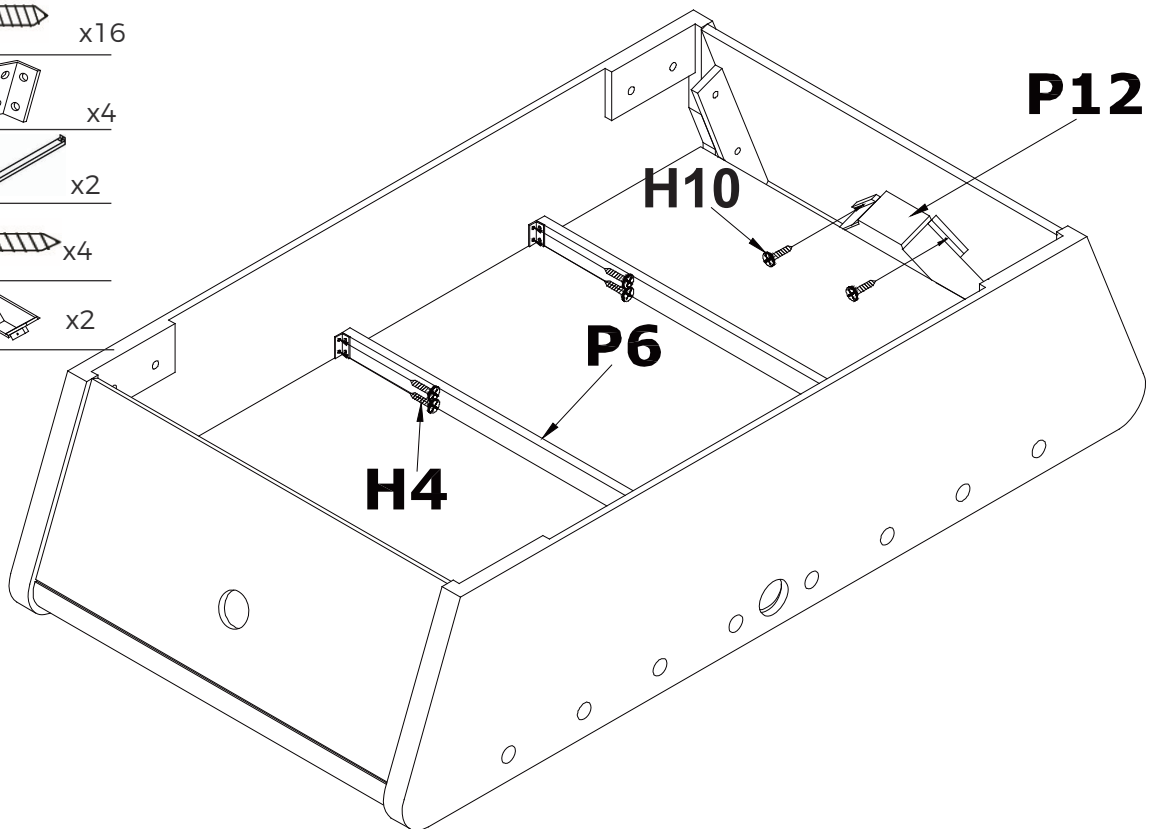


FIG. 4



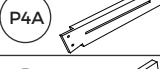
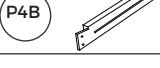

# STEP 4

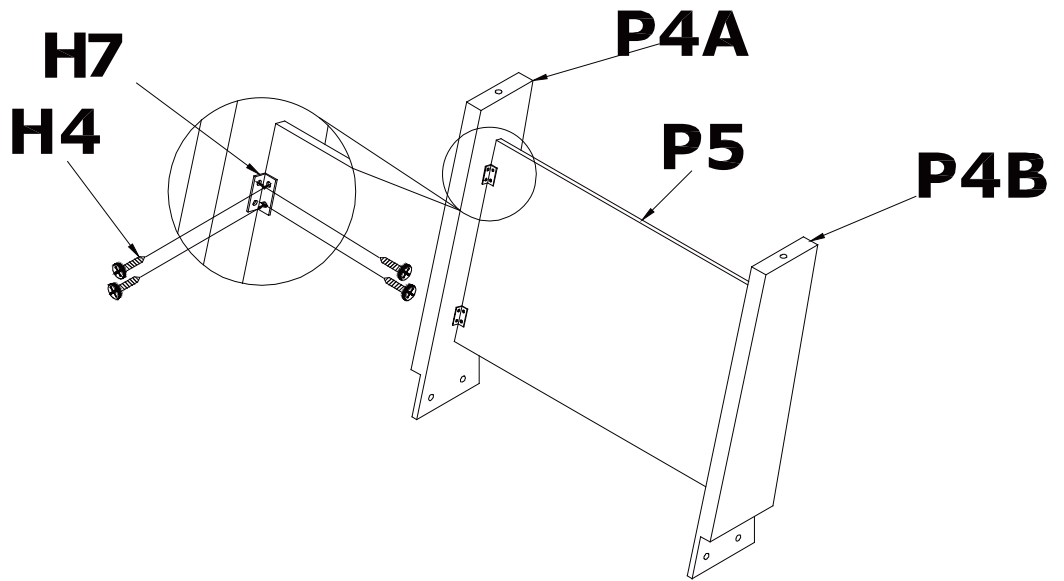
- H4  x16
- H7  x4
- P6  x2
- H10  x4
- P12  x2



## STEP 5

FIG.5

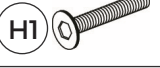


-  H4 x32
-  H7 x8
-  P4A x2
-  P4B x2
-  P5 x2

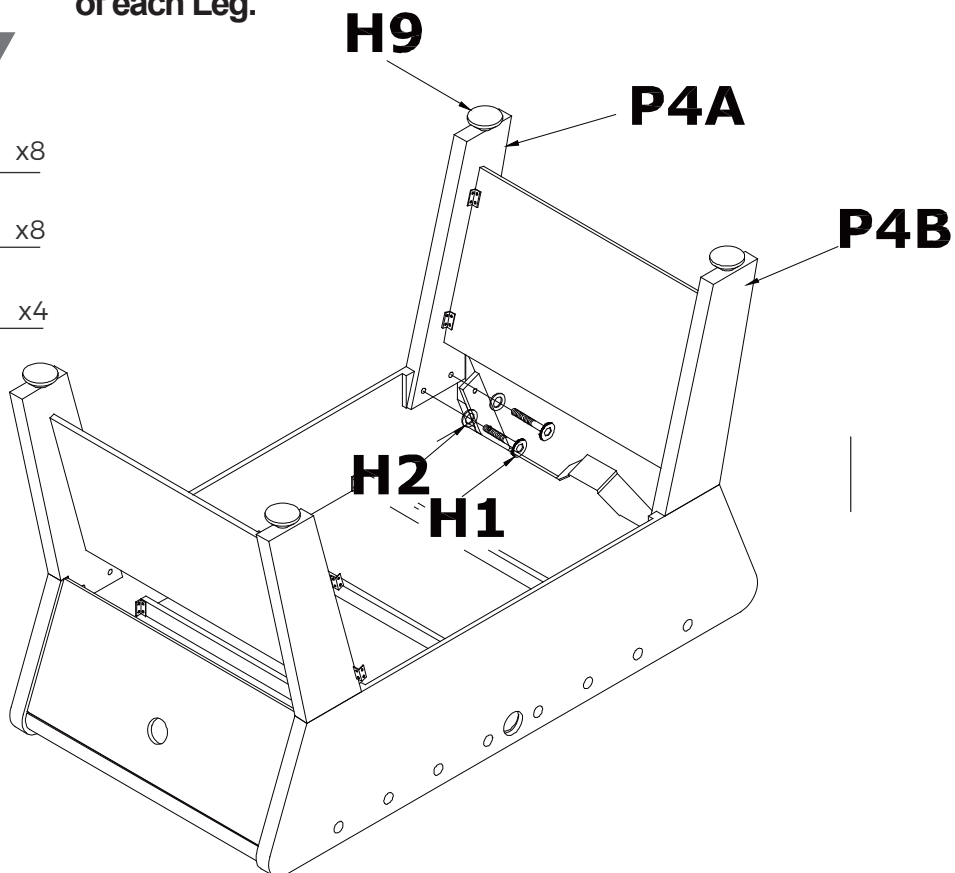


## STEP 6

Use H1 and H2 to attach Leg. Screw the Leg levelers(H9) into the bottom of each Leg.






FIG6

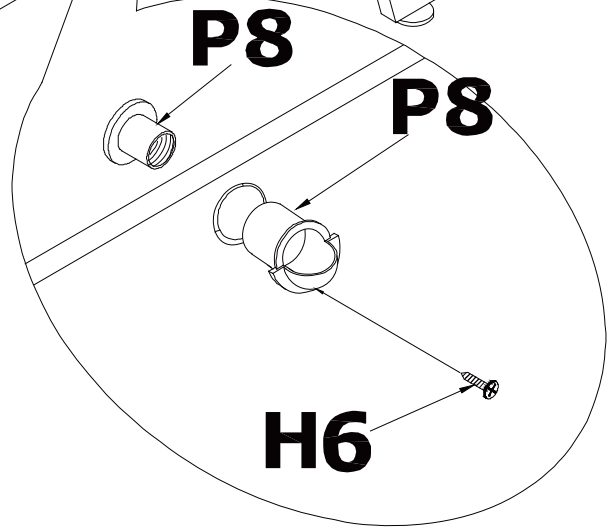
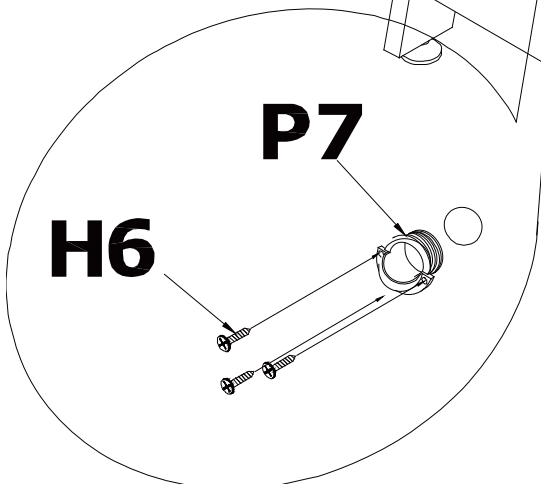
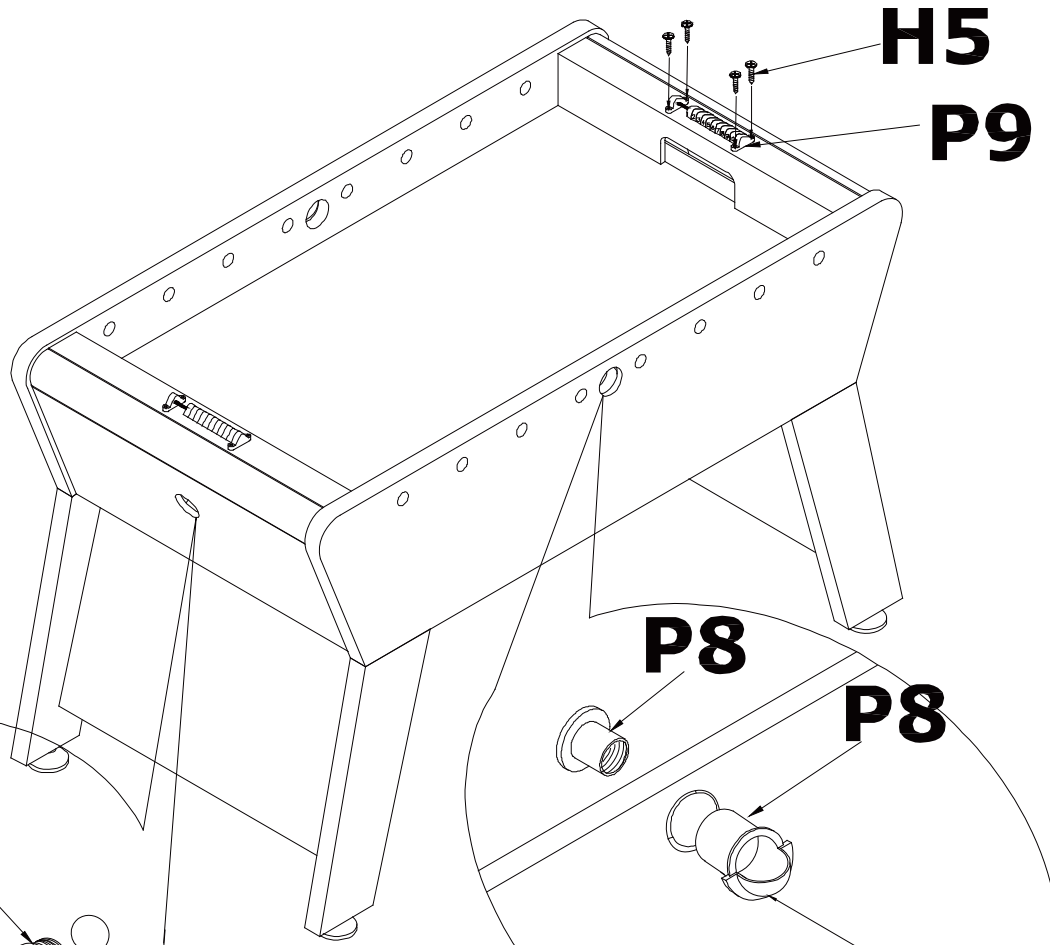
-  H1 x8
-  H2 x8
-  H9 x4



# STEP 7



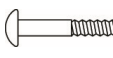








FIG.7

- H6**  x8
- P7**  x2
- P8**  x2
- H5**  x8
- P9**  x2



# STEP 8

FIG.8

- C4**  x16
- C5**  x16
- C6**  x26
- C7**  x26
- C8**  x26
- C9**  x26
- C1**  x4
- C2**  x2
- C3**  x2
- P10**  x8
- P11**  x8

