

DEHUMIDIFIER

Operation Instruction

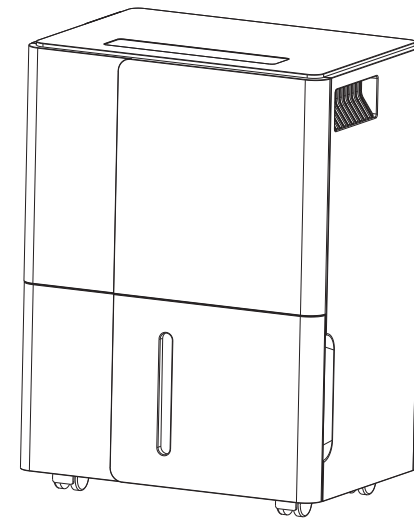

ITEM NO. D6550-ZA
MODEL NO. FDD22-5310V1R3





CONTENTS

■ Precautions	2
■ Operation and Efficiency	6
■ Part Names and Functions	7
■ Operation Panel	8
■ Operation Manual	9
■ Preparations and Inspection for Start	10
■ Clean the Filter and Continuous Drainage	11
■ Maintenance Notices	13
■ Select Proper Functions	14
■ Malfunction Disposals	15
■ Performance Parameters	16

Please read this manual carefully before using this dehumidifier. Since the operation guide contained in this manual is very important, please keep it properly.

Precautions

Please read "Precaution" carefully before operating your dehumidifier. The Warnings and the cautions stated in "Precautions" must be observed for safe operation.

-  Warning means improper handling may result in a death or a serious injury to a person.
-  Cautions means improper handling may result in an injury or damage to properties.
-  Shows Prohibition
-  Shows Compulsion
-  Shows Caution



Warnings



Caution, risk of fire
Attention, risque d'incendie

- In case of any abnormality, be sure to turn off the dehumidifier, disconnect the plug and make contact to the seller of your appliance.
(Abnormal operation may result in a failure of the unit, electric shock, fire, or the like.)



Pull off plug

- Never attempt to turn off the dehumidifier by disconnecting the plug.



Prohibit

- Never modify the dehumidifier. Do not attempt to disassemble or service the unit by yourself.



Prohibit disassembly

- Keep your hands dry while plugging into or pulling off the plug to avoid electric shock.



Prohibit wet hand

- AC 115 volt of alternating current is applied to this equipment.

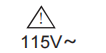

115V~
alternating current

- Remove any dust from the blades of the power plug and insert the plug into an outlet securely.

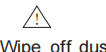

Wipe off dust

- To avoid the risk of fire or explosion, do not spray to the dehumidifier. Do not put any inflammables or chemicals near the unit.



Prohibit

- To prevent resin parts from melting or catching on fire, do not place the dehumidifier near heating appliances.



Prohibit

- Do not connect the dehumidifier to an outlet having the electrical ratings below the dehumidifier's.



Prohibit

- The power cord must not be damaged or modified. Do not put any hot or heavy thing on the cord. Do not pull it out, or bundle it during operation.



Prohibit

- To avoid damages to the power cord, do not pinch the cord in a door.
- Never put rods or objects into the openings of the dehumidifier. Because this unit contains a fan running at high speed, contact with the moving fan will injure your hand or eyes or body.
- Remove water that has been collected in the tank. (Accidentally drinking of the water or using it for other purpose may cause illness and /or unforeseen accidents.)
- Risk of electric shock. Disconnect power before servicing unit moving parts. Do not operate hot parts of the unit with back cover removed. Do not operate unit with back cover removed. Risk of electric shock-switch in off position does not de-energize all loads.



Prohibit



Prohibit



Throw away



Warning

Correct Disposal of This Product

WARNING

Do not use means to accelerate the defrosting process or to clean, other than those recommended by the manufacturer. The appliance shall be stored in a room without continuously operating ignition sources (for example: open flames, an operating gas appliance or an operating electric heater. Do not pierce or burn. Be aware that refrigerants may not contain an odour.

The maximum refrigerant charge amount: 120g (4.23 oz)

Safety Instructions during Servicing

1. The manual shall contain specific information about the required qualification of the working personnel for maintenance, service and repair operations. Every working procedure that affects safety means shall only be carried out by competent persons.
2. Prior to beginning work on systems containing FLAMMABLE REFRIGERANTS, safety checks are necessary to ensure that the risk of ignition is minimized.
3. Work shall be undertaken under a controlled procedure so as to minimize the risk of a flammable gas or vapor being present while the work is being performed.
4. All maintenance staff and others working in the local area shall be instructed on the nature of work being carried out. Work in confined spaces shall be avoided.
5. The area shall be checked with an appropriate refrigerant detector prior to and during work, to ensure the technician is aware of potentially toxic or flammable atmospheres. Ensure that the leak detection equipment being used is with all applicable refrigerants, i. e. non sparking, adequately sealed or intrinsically safe.
6. If any hot work is to be conducted on the refrigerating equipment or any associated parts, appropriate fire extinguishing equipment shall be available to hand. Have a dry powder or CO2 fire extinguisher adjacent to the charging area.
7. No person carrying out work in relation to a REFRIGERATING SYSTEM which involves exposing any pipe work shall use any sources of ignition in such a manner that it may lead to the risk of fire or explosion. All possible ignition sources, including cigarette smoking, should be kept sufficiently far away from the site of installation, repairing, removing and disposal, during which refrigerant can possibly be released to the surrounding space. Prior to work taking place, the area around the equipment is to be surveyed to make sure that there are no flammable hazards or ignition risks. "No Smoking" signs shall be displayed.
8. Ensure that the area is in the open or that it is adequately ventilated before breaking into the system or conducting any shall use any sources of ignition in such a manner that it may lead to the risk of fire or explosion. All possible ignition hot work. A degree of ventilation shall continue during the period that the work

A degree of ventilation shall continue during the period that the work is carried out. The ventilation should safely disperse any released refrigerant and preferably expel it externally into the atmosphere.

9. Repair and maintenance to electrical components shall include initial safety checks and component inspection procedures. If a fault exists that could compromise safety, then no electrical supply shall be connected to the circuit until it is satisfactorily dealt with. If the fault cannot be corrected immediately but it is necessary to continue operation, an adequate temporary solution shall be used. This shall be reported to the owner of the equipment so all parties are advised. Initial safety checks shall include: -that capacitors are discharged: this shall be done in a safe manner to avoid possibility of sparking; -that no live electrical components and wiring are exposed while charging, recovering or purging the system; -that there is continuity of earth bonding.

10. During repairs to sealed components, all electrical supplies shall be disconnected from the equipment being worked upon prior to any removal of sealed covers, etc. If it is absolutely necessary to have an electrical supply to equipment during servicing, then a permanently operating form of leak detection shall be located at the most critical point to warn of a potentially hazardous situation.

11. Particular attention shall be paid to the following to ensure that by working on electrical components, the casing is not altered in such a way that the level of protection is affected. This shall include damage to cables, excessive number of connections, terminals not made to original specification, damage to seals, incorrect fitting of glands, etc. Ensure that the apparatus is mounted securely. Ensure that seals or sealing materials have not degraded to the point that they no longer serve the purpose of preventing the ingress of flammable atmospheres. Replacement parts shall be in accordance with the manufacturer's specifications.

12. Do not apply any permanent inductive or capacitance loads to the circuit without ensuring that this will not exceed the permissible voltage and current permitted for the equipment in use.

13. Intrinsically safe components are the only types that can be worked on while live in the presence of a flammable atmosphere. The test apparatus shall be at the correct rating.

14. Replace components only with parts specified by the manufacturer. Other parts may result in the ignition of refrigerant in the atmosphere from a leak.

15. Check that cabling will not be subject to wear, corrosion, excessive pressure, vibration, sharp edges or any other adverse environmental effects. The check shall also take into account the effects of aging or continual vibration from sources such as compressors or fans.

- a. "The appliance shall be installed in accordance with national wiring regulations"
- b. "If the supply cord is damaged, it must be replaced by the manufacturer, its service agent or similarly qualified persons in order to avoid a hazard."
- c. "This appliance is not intended for use by persons (including children) with reduced physical, sensory or mental capabilities, or lack of experience and knowledge, unless they have been given supervision or instruction concerning use of the appliance by a person responsible for their safety."
- d. "Children should be supervised to ensure that they do not play with the appliance."



Warning



Cautions

- The dehumidifier must be used on a level and stable surface.
- To prevent the water from freezing, do not use the dehumidifier and the drain hose at ambient temperature below 32°F.
- Do not use the dehumidifier outside. Exposure to direct sunlight or rain may result in overheating, electric shock and fire.





















Use in flat ground



Prohibit



Prohibit

- Do not use the dehumidifier outside. Exposure to direct sunlight or rain may result in overheating, electric shock and fire.  Prohibit
- Do not put water vessel on the dehumidifier (In case of any spill of water, the water gets into the unit and deteriorates the insulation)  Prohibit
- Never attempt to use the dehumidifier for special uses, such as food or preservation of art objects, or the like. The deterioration of preserving quality may be caused.  Prohibit
- Do not use the dehumidifier where any leakage of oil or flammable gas may take place.  Prohibit
- Do not use the unit in places subject to chemicals.  Prohibit
- For continuous draining, make sure that the drain hose is set properly without a rising slope.  Ensure drain hose
- Be careful that a heating appliance is not exposed to the wind from the dehumidifier.  Prohibit
- Do not use the dehumidifier as a chair or a footstool.  Prohibit
- For safety purpose, disconnect the power plug if the unit is not use for a long time. 
- Be sure to take hold of the power plug when plugging in and out of an outlet. 
- In case of using the dehumidifier in a closet, be sure to prevent children from getting in the closet.  Prohibit
- Do not remove the float lever from the water tank.  Prohibit
- To avoid damages to the power cord, do not pull out the cord when moving the unit.  Prohibit
- Do not block up the air intakes and the air outlets. Do not cover the unit with washed clothes.  Prohibit
- Prior to continuous operation for a long duration, periodical checking is required especially for the air clean filter, the drain hose, or the like.  Schedule check out
- Turn off the unit and disconnect the power plug before starting any cleaning or other routine maintenance. 
- To avoid the risk of electric shock, never sprinkle or spill water on the dehumidifier when cleaning.  Prohibit
- Turn off the unit and empty the water out of the water tank when moving the unit. Be sure to hold the handle when moving.  Shut off operation and drain water when moving

Operation and Efficiency

Defrosting Operation

The evaporator in the dehumidifier may defrost automatically, if it is operated in the room temperature less than 32 °F. The defrosting device may start up and operate for some time (about 5 minutes) automatically every 25 minutes or even longer.

- During the defrosting operation, the dehumidification function and air purification function may intermit.
- Please don't turn off the switch or pull out the power plug of the dehumidifier during the defrosting operation.

This dehumidifier can't be applicable to keep extreme low temperature. The purpose of this dehumidifier is to pump off the unpleasant high humidity in daily life and dry the wet things. But it can't be used to keep extreme low temperature.

The room temperature increases during the operation.

This dehumidifier doesn't have cooling function. It will produce heat during the operation and increase the room temperature 2-7 °F (1-4 °C). This temperature rise may be very distinct in the cabinet or other similar spaces. In addition, the door and windows are closed and other appliances in the room can give out heat as well as the radiation of the sun can raise the room temperature.

Dehumidifying Capacity

The illustration below shows the daily dehumidifying capacity of the dehumidifier. This capacity is based on the 86 °F of room temperature, the dehumidifier sets 80% of relative humidity and the data when the air outlet is fully open. At different temperatures and relative humidity, it may have different dehumidifying capacities.

In the same room temperature, the dehumidifying capacity is higher in higher relative humidity and the dehumidifying capacity is lower in lower relative humidity. In the same relative humidity, the dehumidifying capacity is higher in higher temperature and the dehumidifying capacity is lower in lower temperature.

If the dehumidifier is placed in the cabinet, its dehumidifying capacity may highly reduce in a short period after operating, that is, the humidity in the cabinet has been highly reduced.

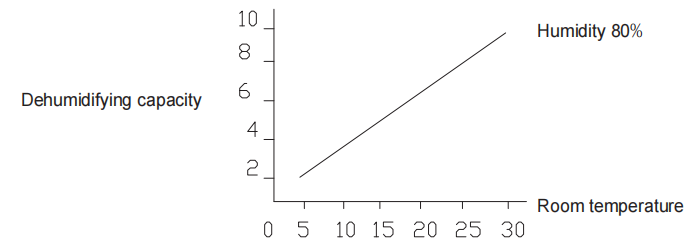

Part Names and Functions

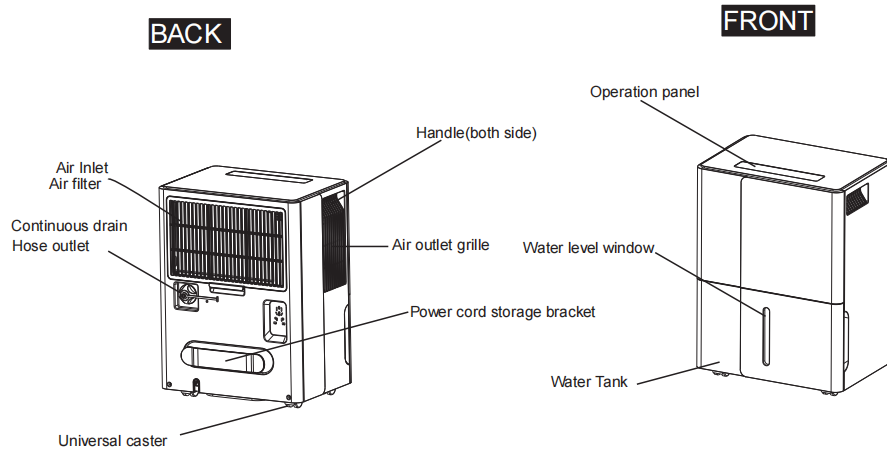

ACCESSORIES

(Placed in the water tank of the dehumidifier)



Power cord storage bracket(1 pc)

(The accessories are packaged in the water tank)

Installation

The following space must be maintained to ensure the operating efficiency of the dehumidifier.

Note

If the dehumidifier gets interference from the household appliances, such as television and radio cassette player, please keep the equipment away from the dehumidifier for over 23 ft.

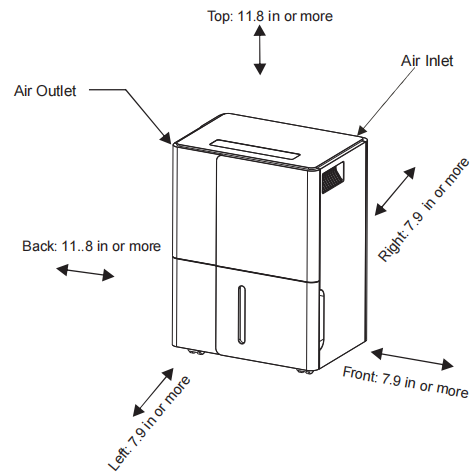

Operation Panel

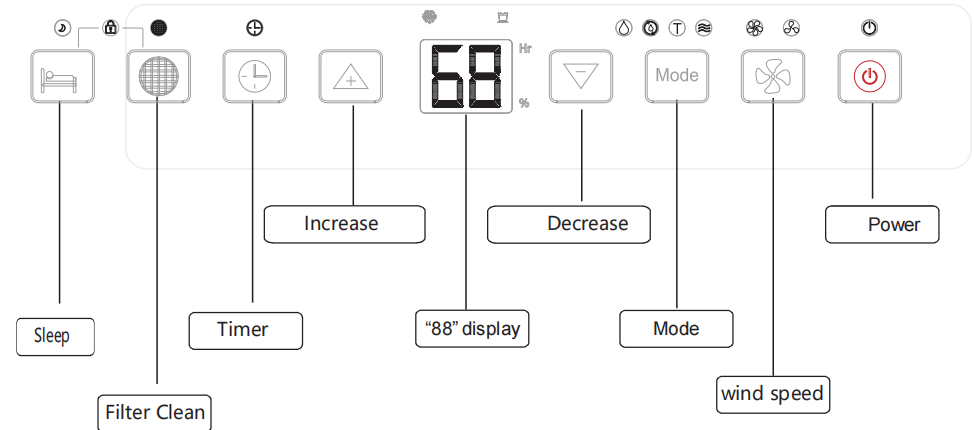

INCREASE BUTTON DECREASE BUTTON





Under the normal dehumidification mode, directly press the plus or minus key to adjust the humidity setting. The setting range is 30%-80% (5% adjustment coefficient) or more. The setting cycle is adjustable. In the timing mode, it is used to set the timing time.

Operation Manual

POWER BUTTON

This key can control the opening and closing of the machine.

MODE BUTTON Mode

Press this key to enter the mode selection status and switch to
Normal Dehumidification  Continuous Dehumidification 
Strong Dehumidification  Ventilation 

WIND SPEED BUTTON

This button can switch the current wind speed to high and low speed in ventilation mode and normal dehumidification mode.

TIMER BUTTON

This key can start the timing setting state, and the time can be set from 0 to 24 hours .



FILTER BUTTON

Long press this button to reset the filter screen alarm (the filter screen alarm light will light up after the machine has been running continuously for 250 hours)

SLEEP

Press the sleep button to enter sleep mode. In sleep mode, pressing any other key will first wake up the display, and then press the button to execute the function.

CHILD LOCK MODE

Long press " " and " " to activate child lock mode, dual 8-screen displays "LC" , long press it again to turn off.

Preparations and Inspection before Start

Confirm the tank is installed in position.

The dehumidifier can't operate if the water in the tank is full or isn't installed well.

1. How to move water tank.

Hold the water tank sides and pull out.

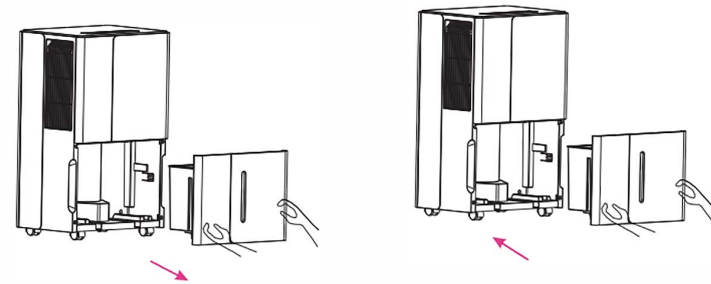

2. Method to empty out the water tank.

- Pull out the water tank from the dehumidifier.
- Incline the water tank according to the indication direction and empty out the water slowly.
- Install the water tank back into the dehumidifier.

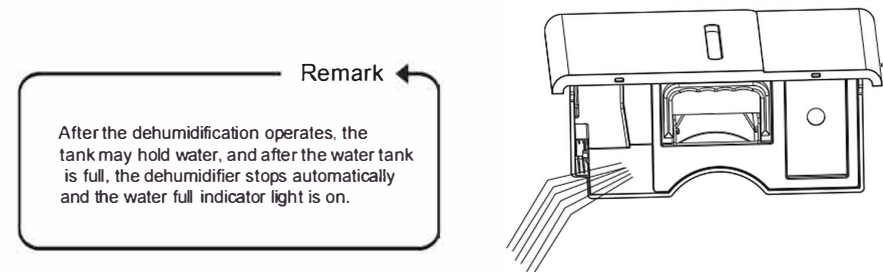

Clean the Filter

Clean the filter screen (maintenance every 250 hours, or the dehumidifier may be damaged.)

The dehumidify capacity may reduce when the filter net is clogged with defilement.

If the filter net is too dirty, it can be cleaned with warm water (below 104 ° F), dried naturally, and then placed back.

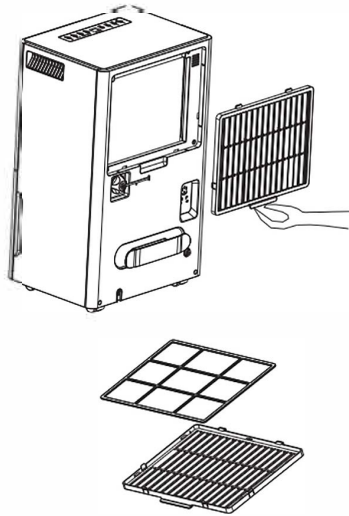

Continuous Drainage

Continuous Drainage

Water can be automatically emptied into a floor drain by attaching the dehumidifier to a female threaded end.

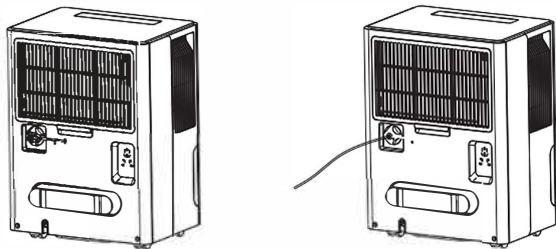

- 1.Remove the plastic cover by counterclockwise rotation.
- 2.Replace and tighten the drainage joint and connect the drainage pipe

! Note

Do not use continuous draining when the outdoor temperature is equal to or less than 32°F (0°C), otherwise the water will freeze, causing the water hose to block up and the dehumidifier may be damaged.

! Note

- Make sure the connection is tight and there is no leaking.

- Lead the water hose to the floor drain or a suitable drainage facility, the drainage facility should be lower than the drain outlet of the dehumidifier.

- Be sure to run the water hose sloping downward to let the water flow out smoothly.
- When the continuous drain feature is not being used, remove the drain hose from the outlet and replace the plastic cover of the continuous drain hose outlet tightly.

! Warning

Please don't catch the power cable in doors to avoid damaging it.



Prohibit



Please keep the children away from the dehumidifier, if it is used in the cabinet.



Prohibit

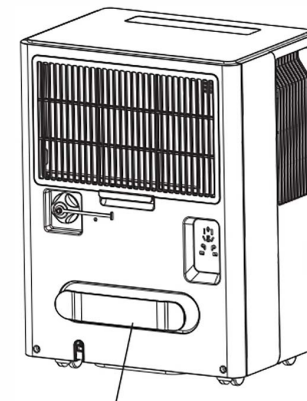

Take out the power cord bracket from the water tank

Maintenance Notices



Warning

Please don't plug in with wet hands to avoid electric shock.



Prohibit wet hand



Notice

Please cut off the power supply before daily cleaning and maintenance.

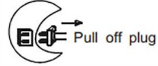

Don't dismantle the floater from the water tank.



Prohibit

If the machine unit is not in use for extended periods:

1. Empty out the water in the tank, wipe up the water tank and install it back.
2. Clean the filter
3. Place the machine unit upright and avoid the direct sunlight.

Requirement

Please place the machine unit upright to avoid misoperation and unusual sound.

Machine body

Wipe up the dehumidifier with wet cloth (put it into the water and wring it out). Don't clean the control panel with wet cloth.

Don't clean the machine unit with gasoline, thinner or liquid detergent to avoid deformation and fission of the machine unit.

The cloth contains chemicals may change the color of the machine unit.



Select Proper Functions

Lower the indoor humidity to a comfortable humidity.

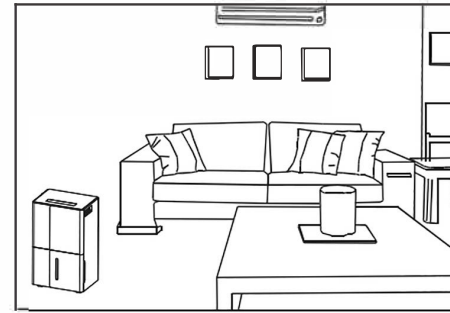

To avoid condensation and mildewing on the ceiling or wall.

Dehumidify for the wardrobe

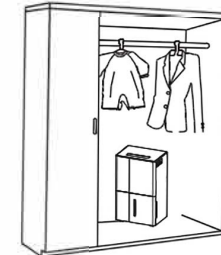

Small space dehumidification



Indoor air filtration



Malfunction Disposals

Please check each item first before applying for maintenance :

Malfunctions	Possible causes	Solutions	
No working	Check whether the power plug is connected.	Plug in.	
	Whether the water tank is full.	Empty out the water in it.	
	Whether the water tank is in position.	Place it well.	
Small dehumidifying capacity.	Whether the filter is too dirty.	Clean the filter.	
	Whether the air inlet and outlet are blocked.	Remove the object blocked or move the dehumidifier to ensure certain inlet and outlet air.	
Big noises	Check whether the machine unit is placed well.	Place the machine unit on the smooth and stable floor.	
Stop during the dehumidifying process.	Whether the room temperature is too high or too low and out of the working scope of the dehumidifier.	The dehumidifier may start automatically when the room temperature returns to the working scope.	
The clothing can't be dry fast.	Whether the room temperature is very low.	The wet clothing may dry more slowly in low temperature.	

Make sure the phenomena below happen while the malfunctions above not included:

Phenomena	Causes
Intermittent stop during the operation	The defrosting process is undergoing.
Small dehumidifying capacity	The dehumidifying capacity drops with the room temperature and humidity. See the illustration above for reference.
The humidity of the room can't reduce.	The room area is too big which is over its application scope. The door and windows of the room aren't closed. The machine unit is operated with a kerosene heater which releases steam together.
Unpleasant smell	The smell may come from the wall, furniture or other things.
The machine unit makes a sound during operation.	The sound made by the flowing of the refrigerant may eliminate or lower automatically while the system operates stably.
Water is in the tank.	Since each machine unit has taken operation test before leaving the factory, some water remains on the evaporator flows to the water tank.
The FULL indicator light is on.	When the water tank is full, the FULL indicator light is on for reminding.

Performance Parameters

Model	FDD22-5310V6R3
Power Supply	AC115V~ 60Hz
Dehumidifying Capacity	22Pints/Day (65 °F 60%RH)
Input Power	250W
Rated Input Current	2.3A
Water Tank Capacity	4.8L (1.2 Gal)
Airflow Volume	118 ft ³ /m
Application Scope	41-95°F
Refrigerant	R32/120g (4.23 oz)

The parameters above may change with the improvement of the machine unit without further notice. See the nameplate for details.

Customer 's Sheet:
Please record the following items.

Model	FDD22-5310V6R3
Purchase Date	
Date	
	TEL