

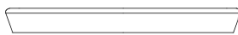





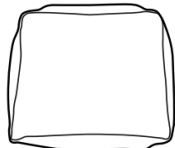

Assembly Instructions

Your sofa comes packaged in one box.
Carefully remove all of components from
the packaging and set aside for assembly.

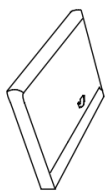
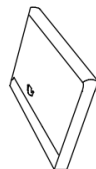
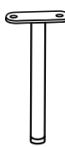
CAUTION
DO NOT use any sharp objects to open
plastic wrapped components as this
may result damage to product or
components .

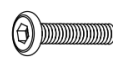
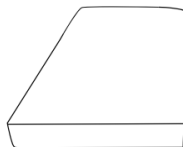
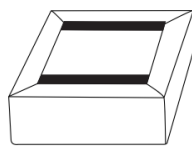
Package Contents

<p>A</p>  <p>1 x Sofa Frame</p>	<p>B</p>  <p>1 x Seat Frame</p>	<p>C</p>  <p>1 x Back Frame</p>	<p>D</p>  <p>3 x Back Cushion</p>	
<p>E</p>  <p>2 x Seat Cushion</p>	<p>F</p>  <p>1x Left Armrest</p>	<p>G</p>  <p>1x Right Armrest</p>	<p>H</p>  <p>2 x Middle Support Leg</p>	
<p>I</p>  <p>8 x Legs</p>	<p>J</p>  <p>4 x Screws</p>	<p>K</p>  <p>1 x Chaise Cushion</p>	<p>L</p>  <p>1 x Chaise Seat</p>	<p>M</p>  <p>1 x Allen Wrench</p>

STEP 1 : Attach the Legs (I) to the Armrests (F) (G) and Chaise Seat(L) .

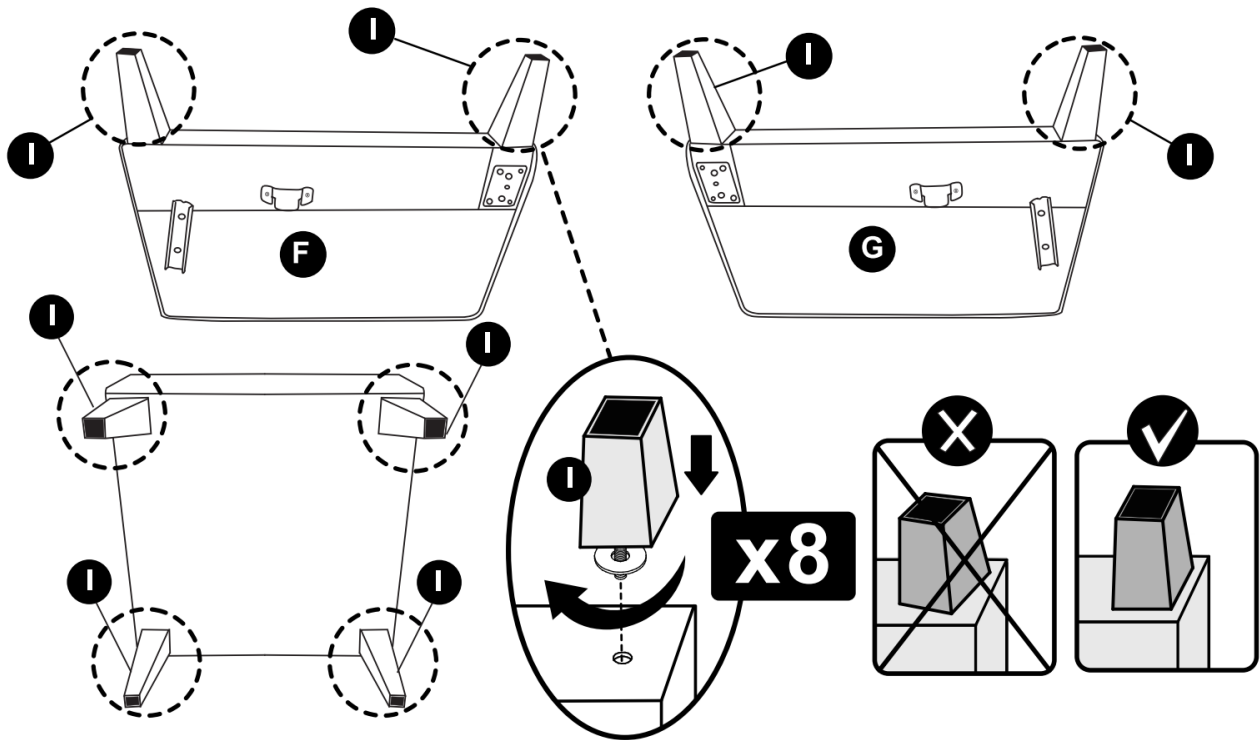

STEP 2 : Use Allen Wrench(M) to attach the Sofa Frame(A) with the Left Armrest (F) and the Right Armrest (G).

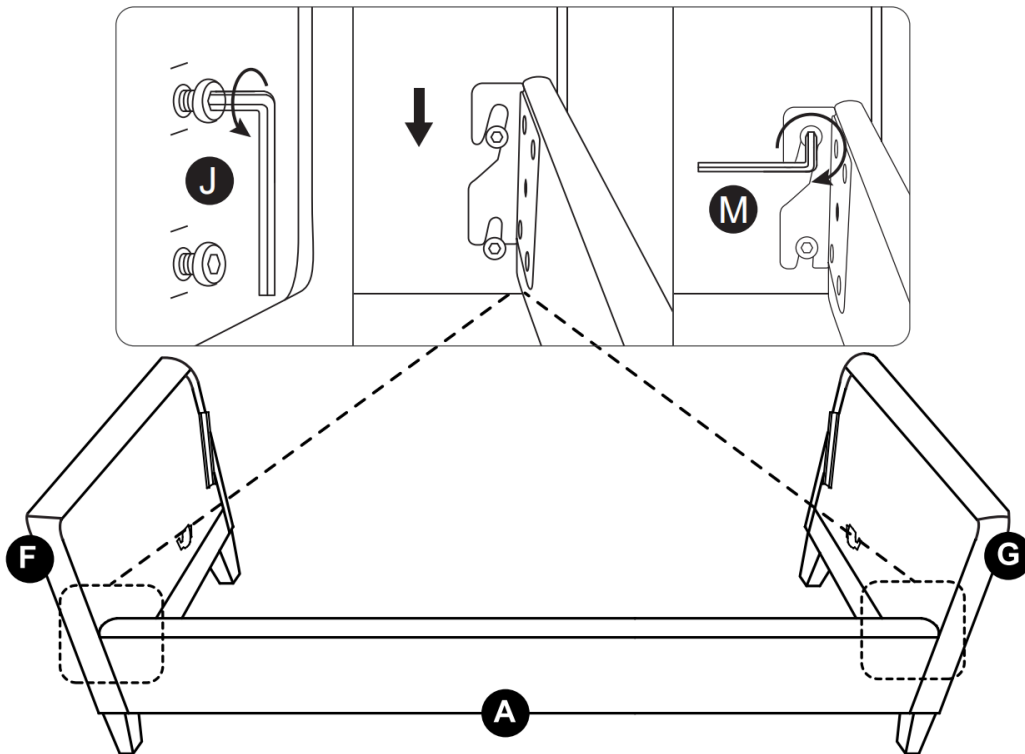

STEP3: Use Screw (J) to attach the Middle Support Leg (H) to the Seat Frame (B) , and insert the Seat Frame (B) into the latch of the Left Armrest (F) and the Right Armrest (G).

*Loosen to get the bolt out of the seat deck
Afloje para sacar el perno del panel del asiento
Desserrer pour sortir le boulon du pont du siège*

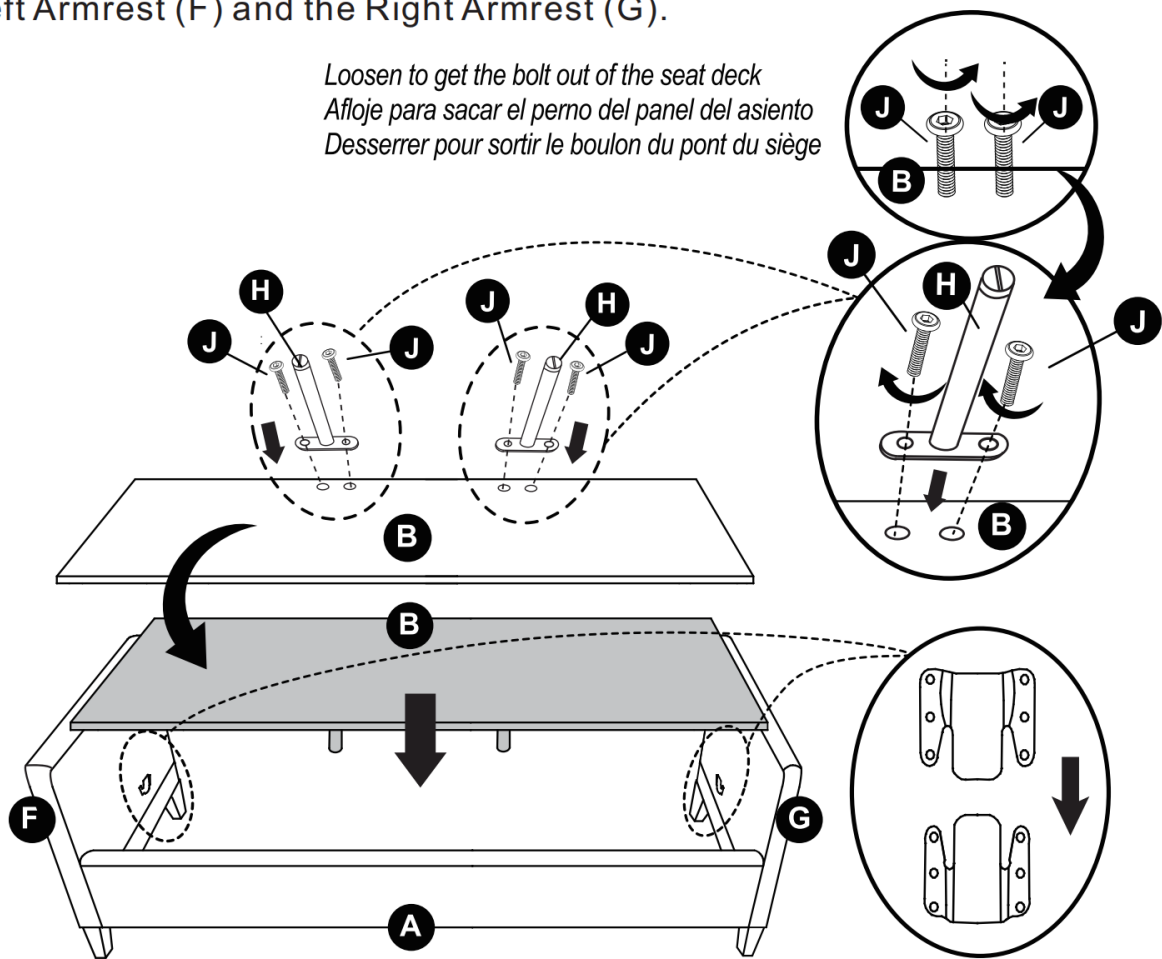

STEP4: Attach the Back Frame (C) to the Left Armrest (F) and the Right Armrest (G).

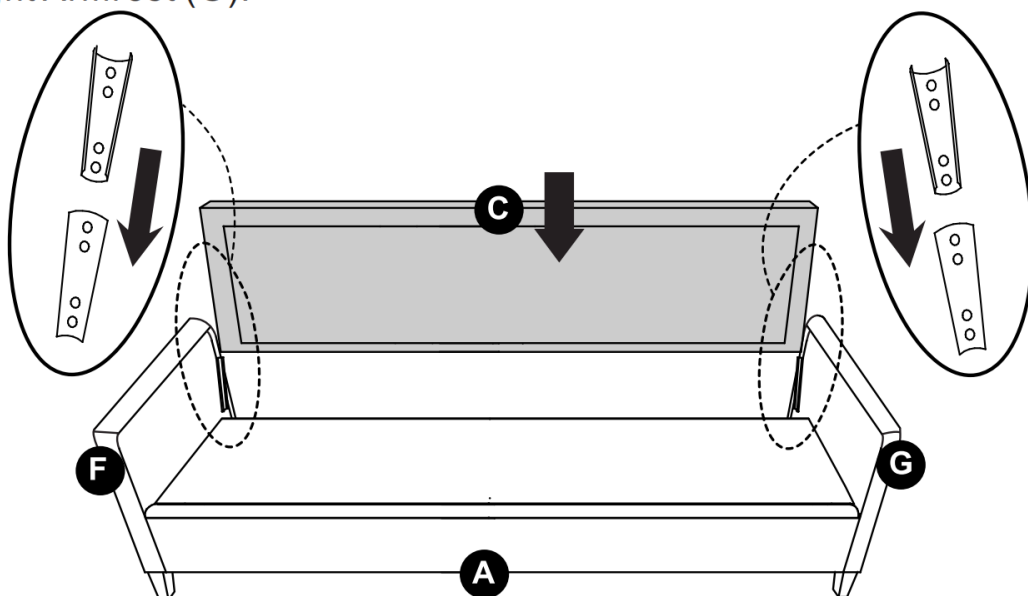

STEP 5: Use Velcro for the back cover of the sofa.

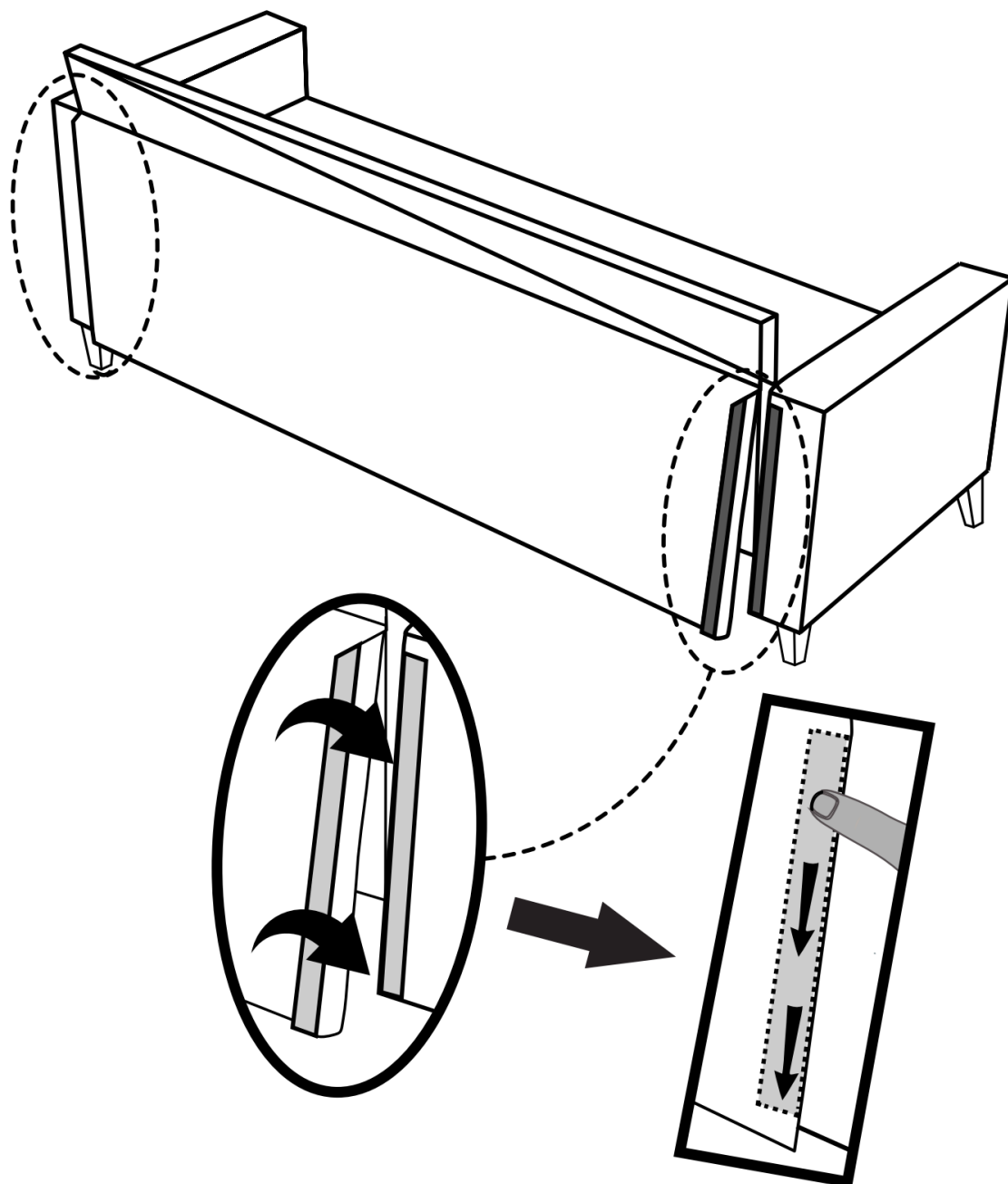

STEP6

- The cushion comes vacuum packed, hence is flat and compressed.
- Le coussin est emballé sous vide, il est donc plat et comprimé..
- El cojín viene empaquetado al vacío, por lo tanto es plano y comprimido.

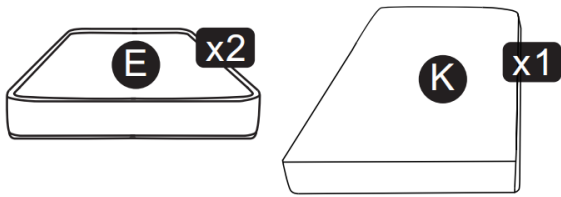

- Please cut the plastic cover of vacuum packed filler carefully. Make sure you do not cut the filler.
- Veuillez couper soigneusement le couvercle en plastique du rempisseur emballé sous vide. Assurez-vous de ne pas couper la charge.
- Por favor, corte cuidadosamente la cubierta de plástico de la llenadora envasada al vacío. Asegúrese de no cortar el relleno.

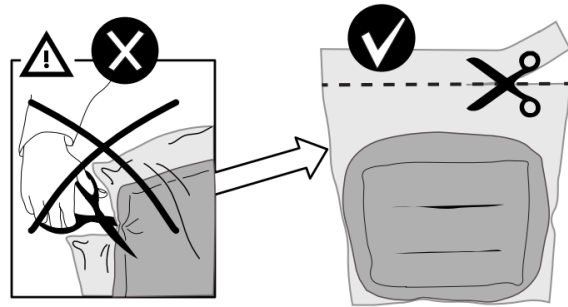

- Take out the cushion filler.
- Sortez le rempisseur de coussin.
- Saca el relleno del cojín.

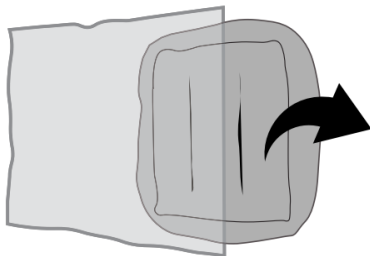

- Re-fluff lightly with hands.
- Re-peluches légèrement avec les mains.
- Vuelva a esponjar ligeramente con las manos.

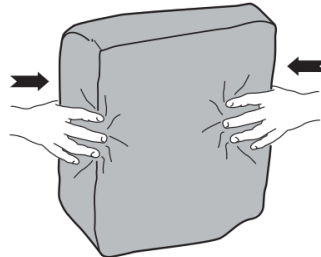

- In 72 hours, the cushion will come to its original shape
- En 72 horas, el cojín endr  a su forma original
- En 72 heures, le coussin retrouvera sa forme d'origine

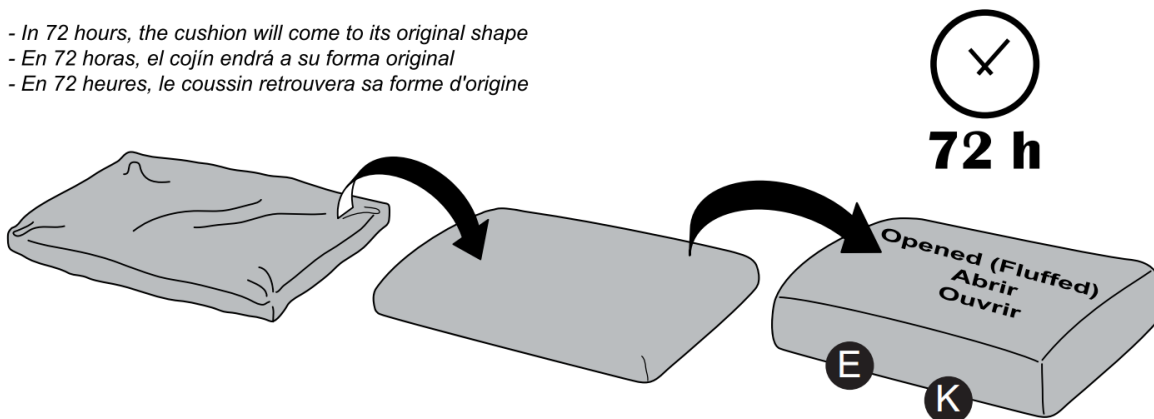

STEP7: Put the Chaise Seat(L) and Chaise Cushion(K) on sofa.

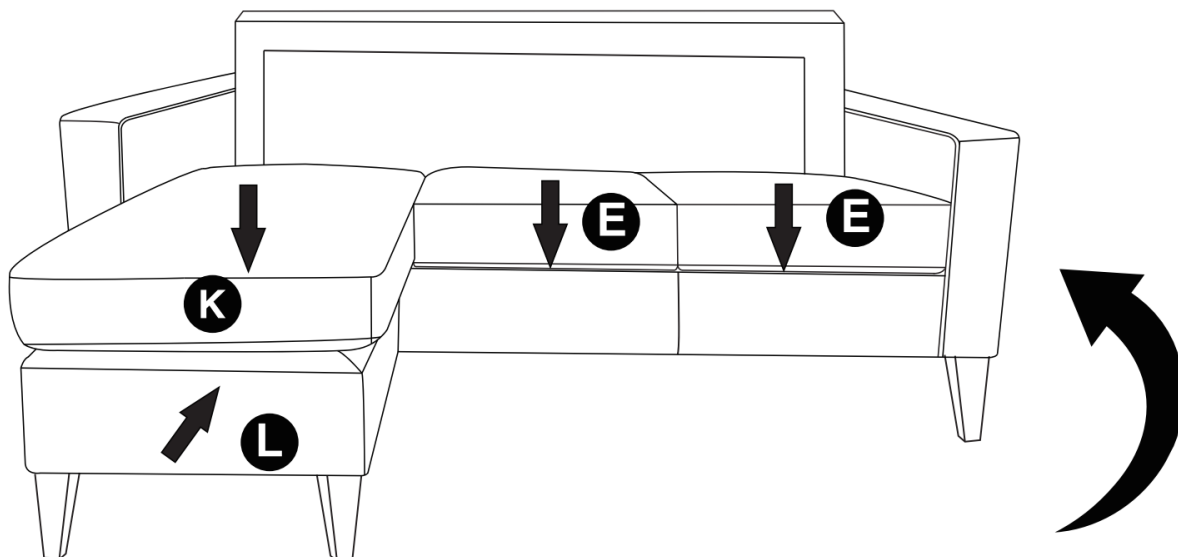

- The chaise cushion **K** **L** can be put either LEFT or RIGHT to fit your requirement.
- El cojín de la chaise **K** **L** puede colocarse a la IZQUIERDA o a la DERECHA para adaptarse a sus necesidades.
- Le coussin de méridienne **K** **L** peut être placé à GAUCHE ou à DROITE pour s'adapter à vos besoins.

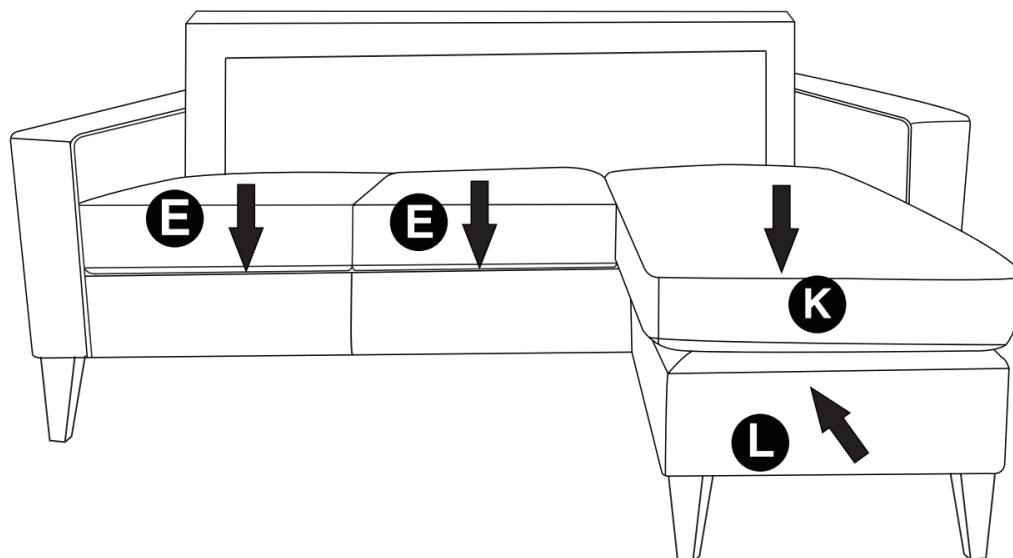

STEP8: Use Velcro to tighten the Back Cushion (D) and the Back Frame (C).

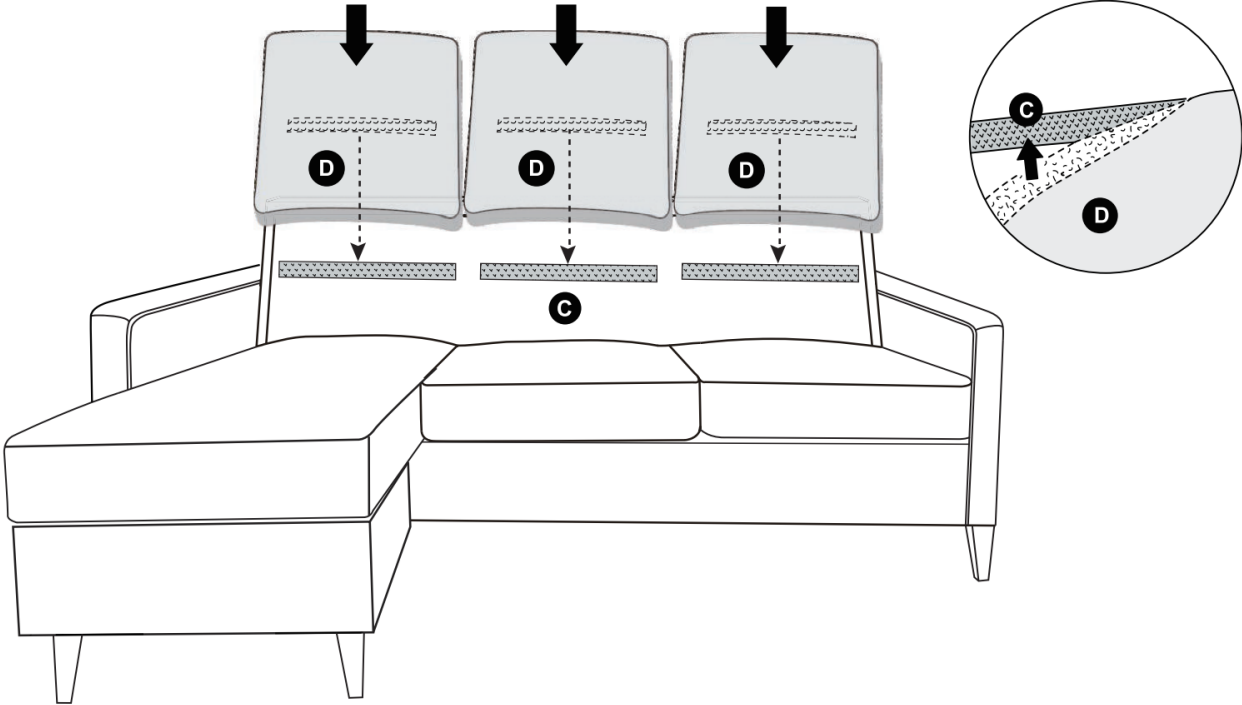

STEP9: Assembly completed.

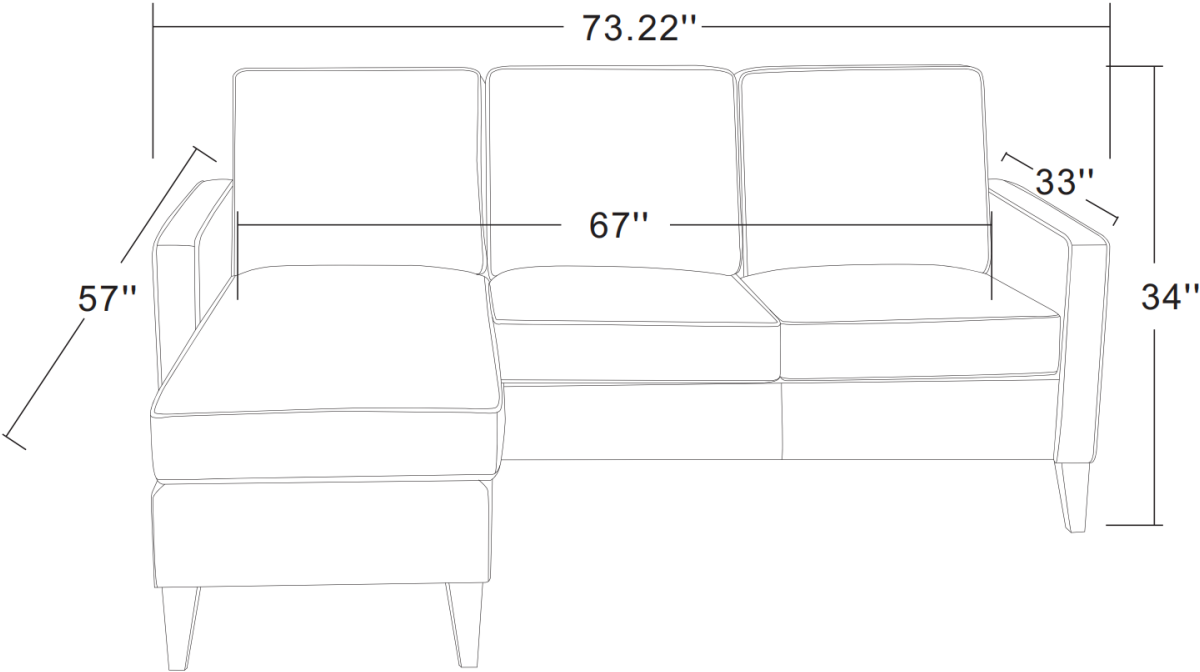

Warnings

1. Please check if the components of the sofa are all included and can be used normally.
2. Assemble all components according to the instruction correctly before you connect the chair to the power.
3. Please DO NOT sit on the armrests or footrest to eliminate the risk of tipping over.
4. If the chair is damaged or doesn't match the website description, please send clear pictures of the product and label of the carton to our service team for further help.
5. If the recliner doesn't work, you may try the following measures for self-checking firstly:
 - a) Check if all the cables are connected;
 - b) Check if the light of transformer is on.

If the chair still doesn't work, please feed the information back to our customer service in time and we'll help you solve the matter as soon as possible.

