

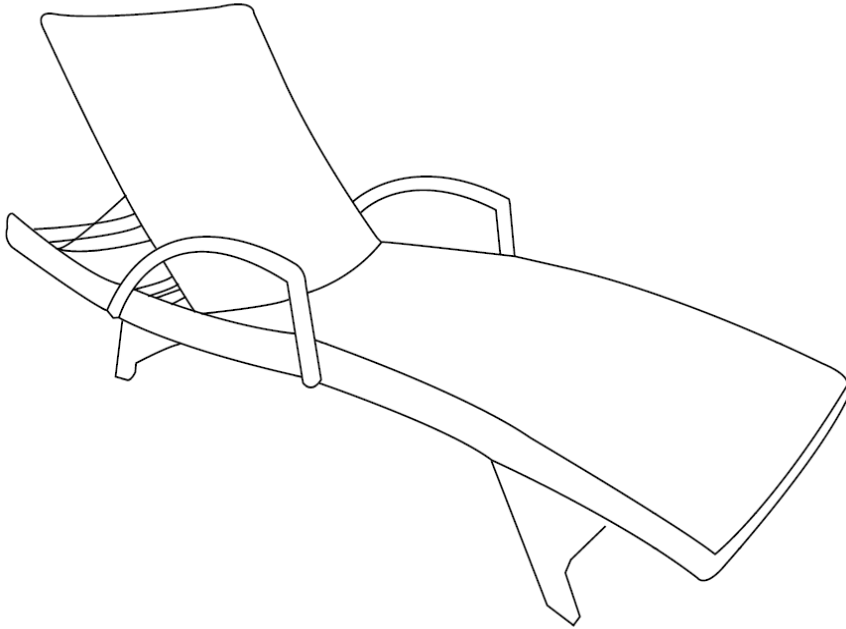



# Assembly Instructions

**Caution : You must read this before you proceed**



## **LOUNGE**



### Parts List

Label	Picture	Description	QTY
A		Seat Panel	1
B		Left Arm	1
C		Right Arm	1

# Hardware

Label	Picture	Description	QTY
①		Bolt (M8x50mm)	5
②		Washer (M8)	5
③		Allen Key (M10)	1

# Assembly Preparation

Before Beginning Assembly:

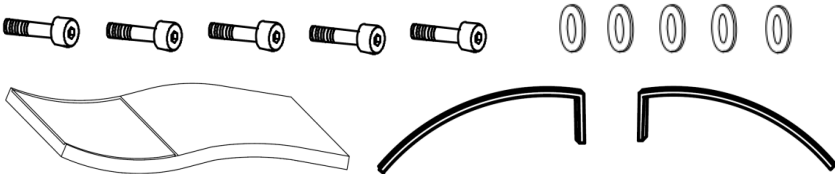

- Read instructions, cover to cover-



- Have 2 adults on hand for assembly-



- Do not assemble on flooring or carpet-



- Assemble on a clean non-marring surface (packing foam)-



- Save all packaging until finished-

# Assembly Steps

## Overview

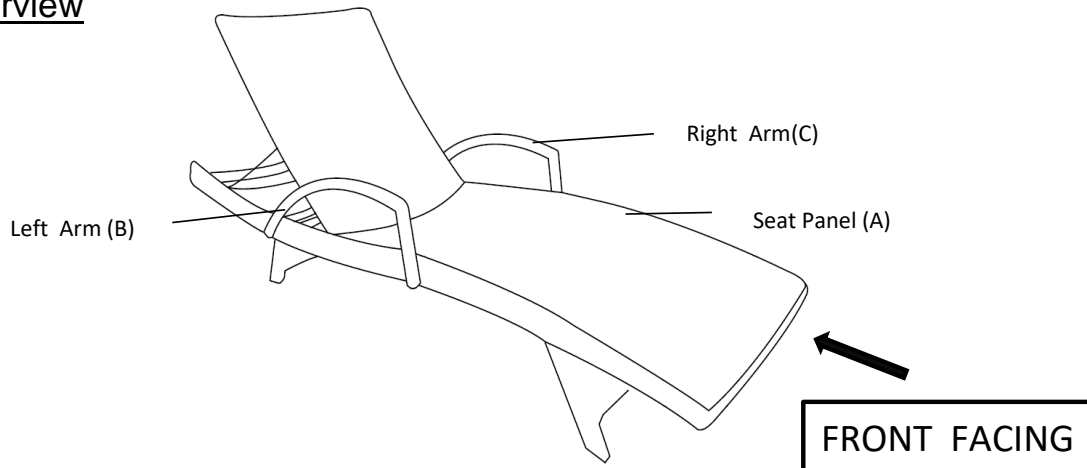

This Lounge has multiple parts and may require up to 15 minutes to assemble. To give you an overview of the Lounge parts, the above picture is to help you put the various parts into perspective. Please read through the instructions below to familiarise yourself with the parts and steps before assembly.

## Step 1

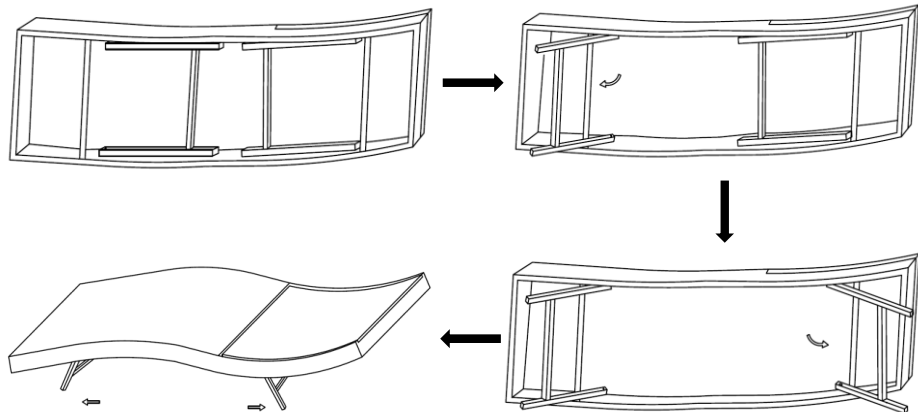

Put the one side of the Lounge as pictured on a clean, non-marring surface. To open, first open the leg under the seat to the maximum angle, and then open the other leg which under back also to the maximum angle, by hand. Then, carefully put the Lounge right side up, lay on the ground. Use a hand to rock the lounge to make sure all the legs have been opened totally.

## Step 2

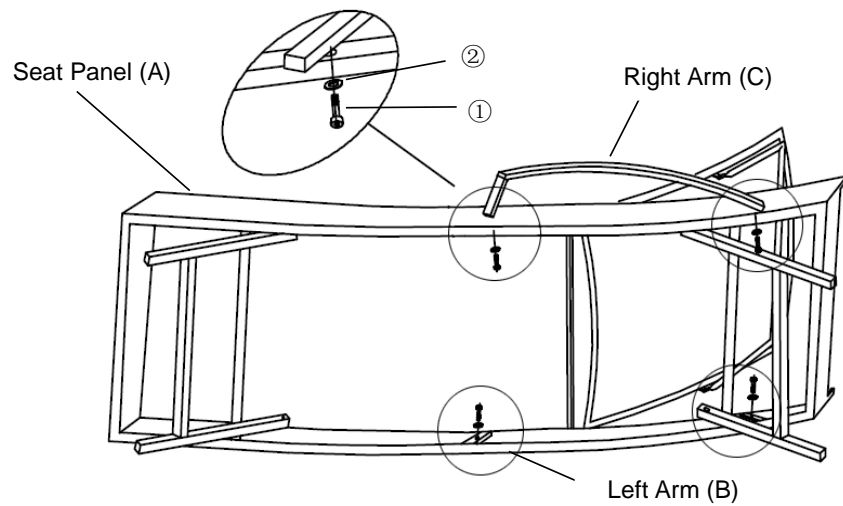

Open the back, Attach Right Arm and Left Arm to the Seat Panel using Bolts (①) , and Washers (②), with Allen Key (③).

## Step 3

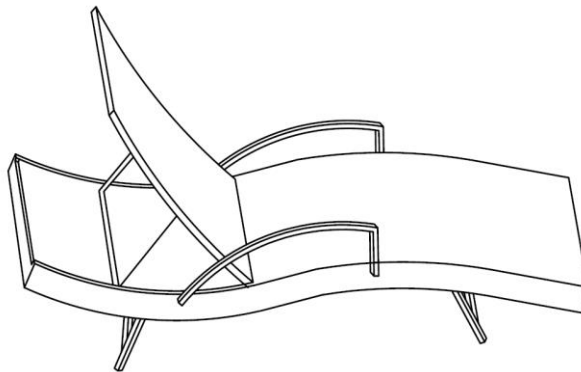

Adjust the adjustable tube of the back, to find the suitable height. Your Lounge is ready for use.





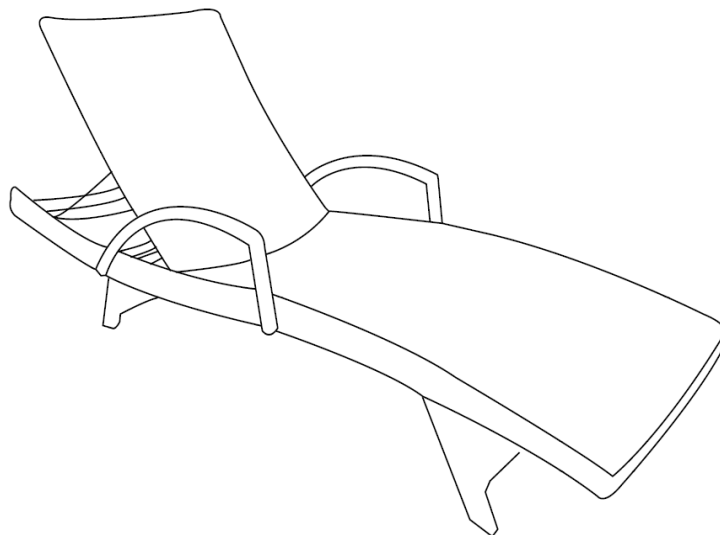















**This Lounge can only be used on a flat, level surface.**

## Step 4



Your Lounge is ready for use.

## Care & Maintenance

-   ● Do not put hot items directly on furniture surface
-   ● Do not clean furniture with harsh cleansers or polish.
-   ● To obtain the longest lifespan of your outdoor products, minimizing exposure to direct sunlight is recommended.
-   ● Children should not climb or jump on the furniture.
-   ● Do not write on furniture without a padded barrier to protect the surface.
-   ● To obtain the longest lifespan of your outdoor products, avoid extended and lengthy exposure to rain, snow, and direct sunshine. Whenever possible cover the product and /or place under patio or awnings.
-   ● Not for commercial use. For residential use only .
-   ● Stains may be removed with mild soap solution and damp cloth.
-   ● Keep away from sources of ignition.
-   ● Dust and pick-up spills using a clean, non-colored, lint-free cloth.