









ASSEMBLY INSTRUCTIONS

Hardware List			
 Table top	1	 Table leg	1
 Support frame	1	 Foot pads	8
 Hexagonal screw tap	1	 8x30mm screws and washers	8
 Spare 4x15mm Self-tapping screws	8	 8x16mm screws and washers	4

STEP 1:

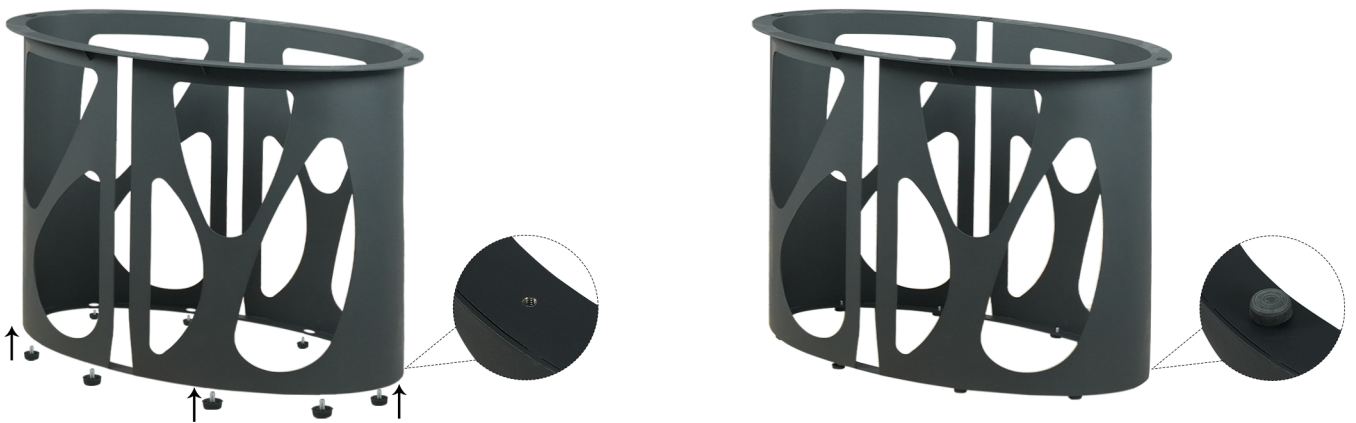

Adjustable foot pads at the bottom of the support legs (when the ground is uneven, the foot pads can be used to adjust the balance).

STEP 2:



Attach the support frame to the support leg with 8x30mm screws.

STEP 3:

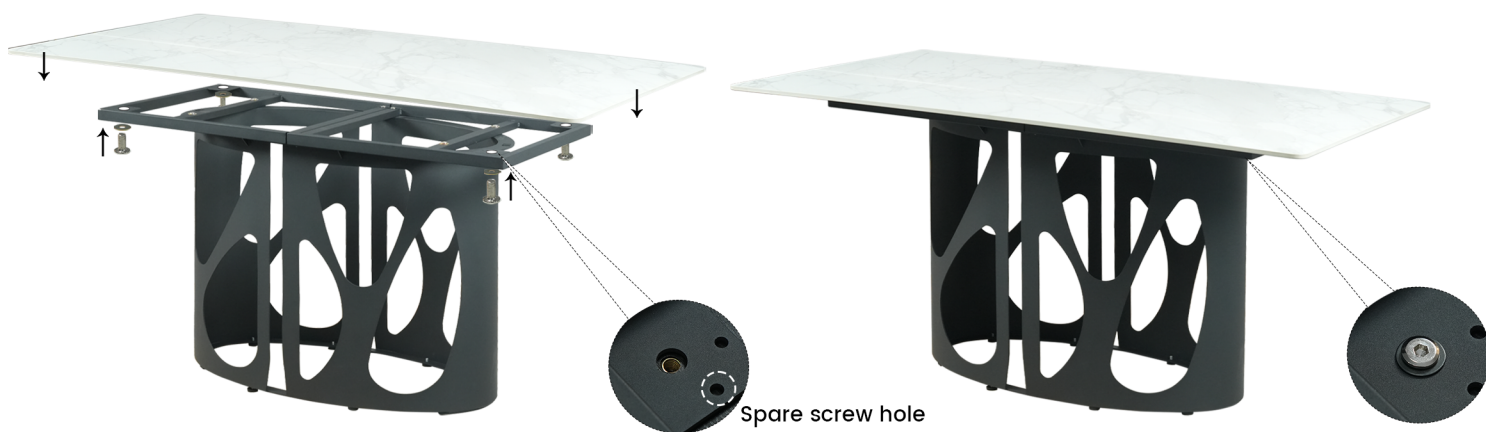

Put the table top on the table leg, make sure the reserved screw holes of the table top and the frame are corresponding, tighten 8x16mm screws from the bottom to finish the installation.

When the 8x16mm screw fails to be screwed in, the hole can be fixed with a 4x15mm self-tapping screw. Either way will do