

# PAVILLONS & PERGOLAS GAZEBO

| A102007900 |

**DE Aufbauanleitung & Nutzungshinweise**  
**GB Assembly and Safety Instructions**

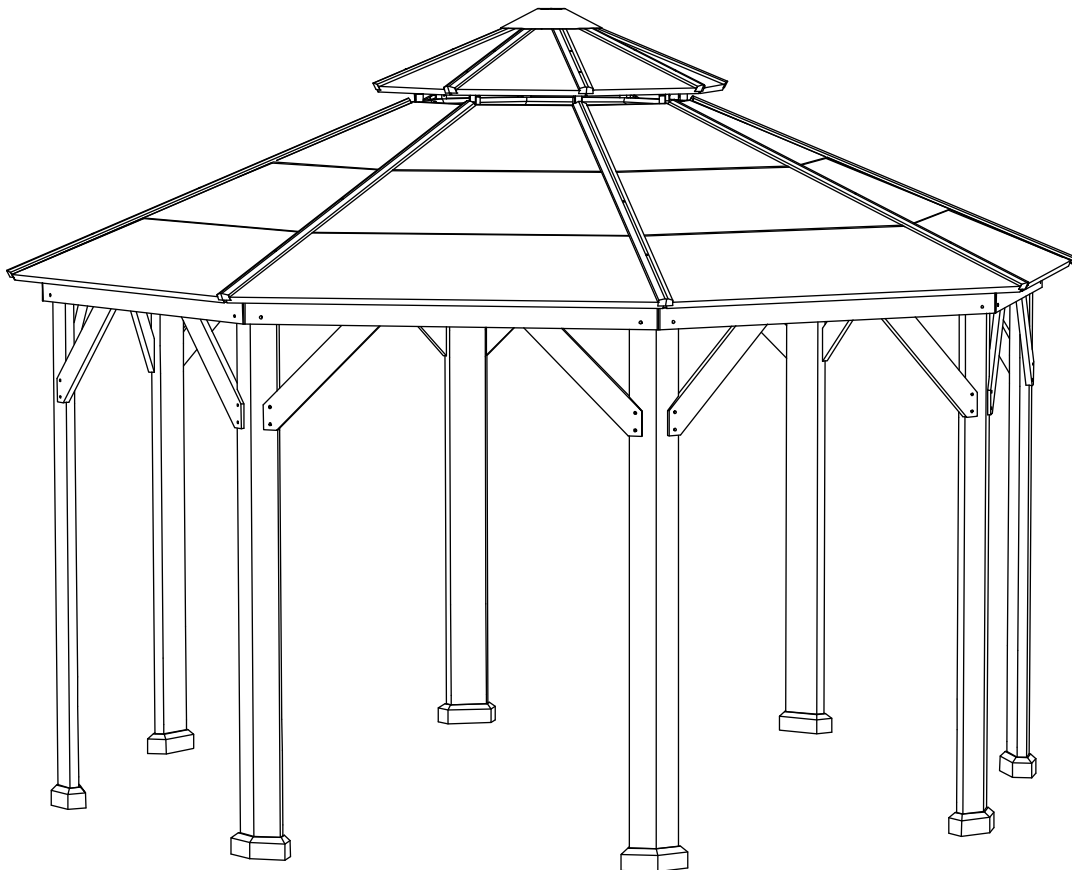

# DE BEDIENUNGS - UND SICHERHEITSHINWEISE

Herzlichen Dank, dass Sie sich für unser Produkt entschieden haben. Bei Fragen, Problemen oder Anreizen wenden Sie sich gerne jederzeit an unseren Kundenservice. Wir wünschen Ihnen viel Freude an Ihrem neuen Produkt.

Um das Risiko von Verletzungen und Beschädigungen am Produkt zu vermeiden, bitten wir Sie die nachfolgenden Sicherheits- und Pflegehinweise und die Aufbauanleitung zu beachten.

## WICHTIG

Bitte beachten Sie ALLE hier aufgelisteten Sicherheits- und Warnhinweise.

Entfernen Sie vor Gebrauch sämtliche Verpackungsmaterialien.

Vor der Montage prüfen Sie bitte die mitgelieferten Teile auf Vollständigkeit und Unversehrtheit.

Die Bedienungs- und Sicherheitshinweise sollten sorgfältig und in der Nähe des Produktes aufbewahrt werden.

Diese Anweisungen sind Teil des Lieferumfangs.

Dieses Produkt ist ausschließlich für den Privatgebrauch geeignet und darf nicht für gewerbliche Zwecke verwendet werden.

## WARNHINWEISE

Es sollte immer ausreichend Abstand zu Schläuchen, Gas- oder Elektroleitungen gewahrt werden. Informieren Sie sich im Vorfeld bei Ihren örtlichen Behörden um Schäden diesbezüglich zu vermeiden.

Falls Sie geeignete Heizgeräte (Auskunft hierzu im Fachhandel) nutzen, halten Sie bitte einen Abstand von mindestens 1,2 m zu Planenmaterial ein. Bitte nutzen sie KEIN offenes Feuer oder Heizgeräte mit offener Flamme im Gazebo.

Sie sind beim Aufbau für die angemessene Verankerung und damit für die Sicherheit das Produkt verantwortlich. Damit die Sicherheit des Produktes und anderer gewährleistet ist, prüfen Sie die Verankerung bitte regelmäßig. Eine gute Verankerung kann die Lebensdauer der Einzelteile und des Gazedos verlängern.

Damit Ihre eigene Sicherheit gewährleistet ist, tragen Sie beim Aufbau bitte einen Helm, Handschuhe und stabile Schuhe. Das Metall kann scharfe Kanten aufweisen und durch die Rostschutzbehandlung ölig sein.

Bei Schneefall, starken Regenfällen oder anderen Belastungen muss unbedingt darauf geachtet werden, dass das Dach regelmäßig und zeitnah gesäubert und von den oben stehenden Dingen befreit wird.

**Erstickungsgefahr** - Plastiktüten und Ersatzteile bitte außer Reichweite von Säuglingen und Kindern aufbewahren.

## **AUFBAU & VERWENDUNG**

---

Planen Sie beim ersten Aufbau etwas mehr Zeit ein. Anschließend wird es immer zügiger gehen. Das Aufbauprinzip ist einfach. Beachten Sie dabei unsere Grafik der einzelnen Schritte.

Führen Sie die Verschraubung der Teile manuell mit einem Inbusschlüssel aus oder mit einem Akkuschauber auf niedriger Stufe. Bitte gehen Sie schonend mit dem Material um.

**VORSICHT** - Bitte achten Sie während der gesamten Montage, dass Sie sich oder andere nicht verletzen, besonders beim Heben schwerer oder langer Teile.

Die Montage sollte ausschließlich von mindestens zwei Erwachsenen durchgeführt werden. Achten Sie darauf, dass sich keine Kinder während des Aufbaus in der Nähe befinden.

Achten Sie darauf, dass Sie das Produkt auf einer geeigneten, ebenen und stabilen Oberfläche aufbauen.

Verwenden Sie nur die mitgelieferten Materialien.

Jedes Land hat Vorschriften für das Errichten von mobilen- Gazebos und immobilien Bauten. Erfragen Sie bitte bei Ihrer örtlichen Behörde, ob Genehmigungen für Ihren Nutzungszweck erforderlich sind. In manchen Ländern ist die Pavilliongröße entscheidend für eine eventuelle Genehmigung.

## **PFLEGE & AUFBEWAHRUNG**

---

Für Schäden jeglicher Art die aufgrund von Naturgewalten auftreten wird keine Garantie übernommen.

Starker Wind kann unter Umständen Schäden am Produkt herbeiführen. Daher sollte das Produkt nicht über längere Zeit unbeaufsichtigt bleiben.

Sehen Sie davon ab, das Metallgestänge zu verändern: weder durch das Anbauen und/oder Anschweißen anderweitiger Materialien, noch durch Einkerbungen und/oder Verformungen des Materials.

## **UMWELT & NACHHALTIGKEIT**

---

Tragen Sie zum Umweltschutz bei: Werfen Sie diese Produkt und/oder Teile davon nicht in den Hausmüll. Bringen Sie es zum Recycling zu einer offiziellen Sammelstelle oder wenden Sie sich an den Hersteller bzw. einen autorisierten Händler.

## **KUNDENSERVICE**

---

Sollten Sie weitere Informationen benötigen oder Probleme auftreten:  
Schreiben Sie bitte eine E-Mail an [helpme@sunjoyonline.eu](mailto:helpme@sunjoyonline.eu).

# **GB ASSEMBLY AND SAFETY INSTRUCTIONS**

---

Thank you for your purchase! If you have any questions, issues or recommendations please feel free to reach out to us.

Please pay close attention to the following instructions in order to reduce the risk of injuries, accidents or damage to the product by itself.

## **IMPORTANT**

---

Please follow ALL safety instructions listed below.

Please remove the packaging material before assembling or using the product.

Please make sure that all listed parts are included in the package and that they are not damaged.

Please read these assembly and safety instructions carefully before usage of the product and keep it for future reference.

This product should only be used in a non-commercial way.

## **SAFETY INFORMATION**

---

Make sure to keep sufficient distance to houses as well as gas and power lines to avoid possible damage. Please check the area for power cables and gas lines. Ask your local authority for further information if needed.

When making use of suitable heaters, keep a minimum distance of 1.2 m to tarp material. Open fire or heaters with open flames such as patio heaters, umbrella heaters, gas heaters etc. should NOT be used inside this product in any case.

The person taking care of the construction of this product is responsible for adequately securing it to ensure its safety. Please check the anchoring constantly to avoid damage. A stable anchoring can extend the endurance of the product.

In order to ensure your own safety, please make sure to wear a helmet, gloves and solid shoes. The metal parts could have sharp edges and could be oily because of rust prevention treatment.

Please make sure that there is no permanent snow load. It should be removed right away. The same applies for rain and other forms of load.

**Warning - please keep plastic and small spare parts out of children's reach. The thin film may cling to nose and mouth and prevent breathing.**

## **ASSEMBLY & USAGE**

---

Please reserve some more time for your first installation of this product. The rules to be followed when pitching this product are simple. Please use the illustrative instructions for each step of installation.

The screws joining the pipes with connectors must be tightened manually, using a hexagon key or an automatic screw driver, set at a max. level 2, to avoid material wear.

**CAUTION** - Please make sure that no one is harmed during the assembly process, especially when lifting heavy parts.

This product should only be assembled by at least two adults. Please keep children away from this product while assembling it to protect them.

Please make sure to find a flat and even ground base that is suitable for the assembly of the product and its intended usage.

Use only those materials provided with the product upon delivery.

Each country has varying regulations regarding movable structures (product) and unmovable structures. Please ask your local authorities whether a permission must be obtained to pitch the product. In some countries this depends on the size of the product.

## **CARE & STORAGE INSTRUCTIONS**

---

Any kinds of damages due to acts of nature (weather damage) are not covered.

Strong winds may damage the product. Please do not leave this product unattended for an extensive amount of time.

Strong or expensive rain may lead to the accumulation of water pockets on the roof. These pockets need to be removed as soon as possible.

Do not make any modifications of the metal structure of the product, such as for example, connecting and/or welding additional loads, making grooves and/or any deformations.

## **ENVIRONMENT & SUSTAINABILITY**

---

Please help us take care of our planet by recycling this product after usage. Please do not dispose of the product or any of its components with ordinary garbage, but recycle it. If in doubt, please contact us or an authorized sales representative. We will be happy to help you recycle the product correctly, at the same time preserving the environment.

## **CUSTOMER SERVICE**

---

If you need any further assistance or information, please do not hesitate to get in touch with us via email: [helpme@sunjoyonline.eu](mailto:helpme@sunjoyonline.eu).

**WERKZEUG / TOOLS**

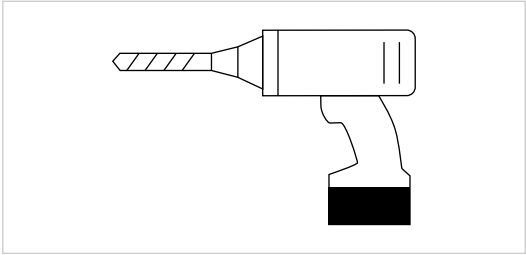
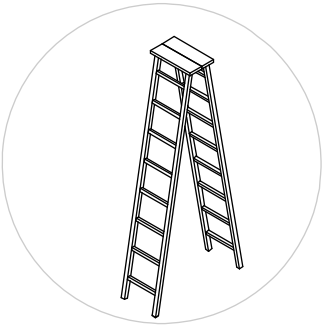
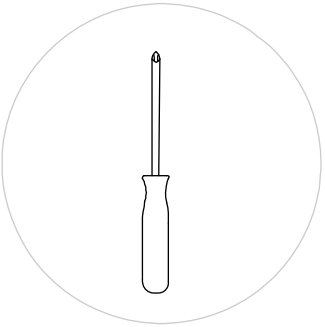





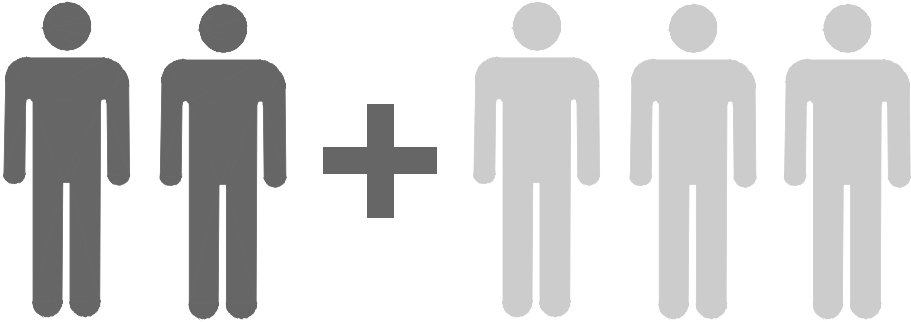

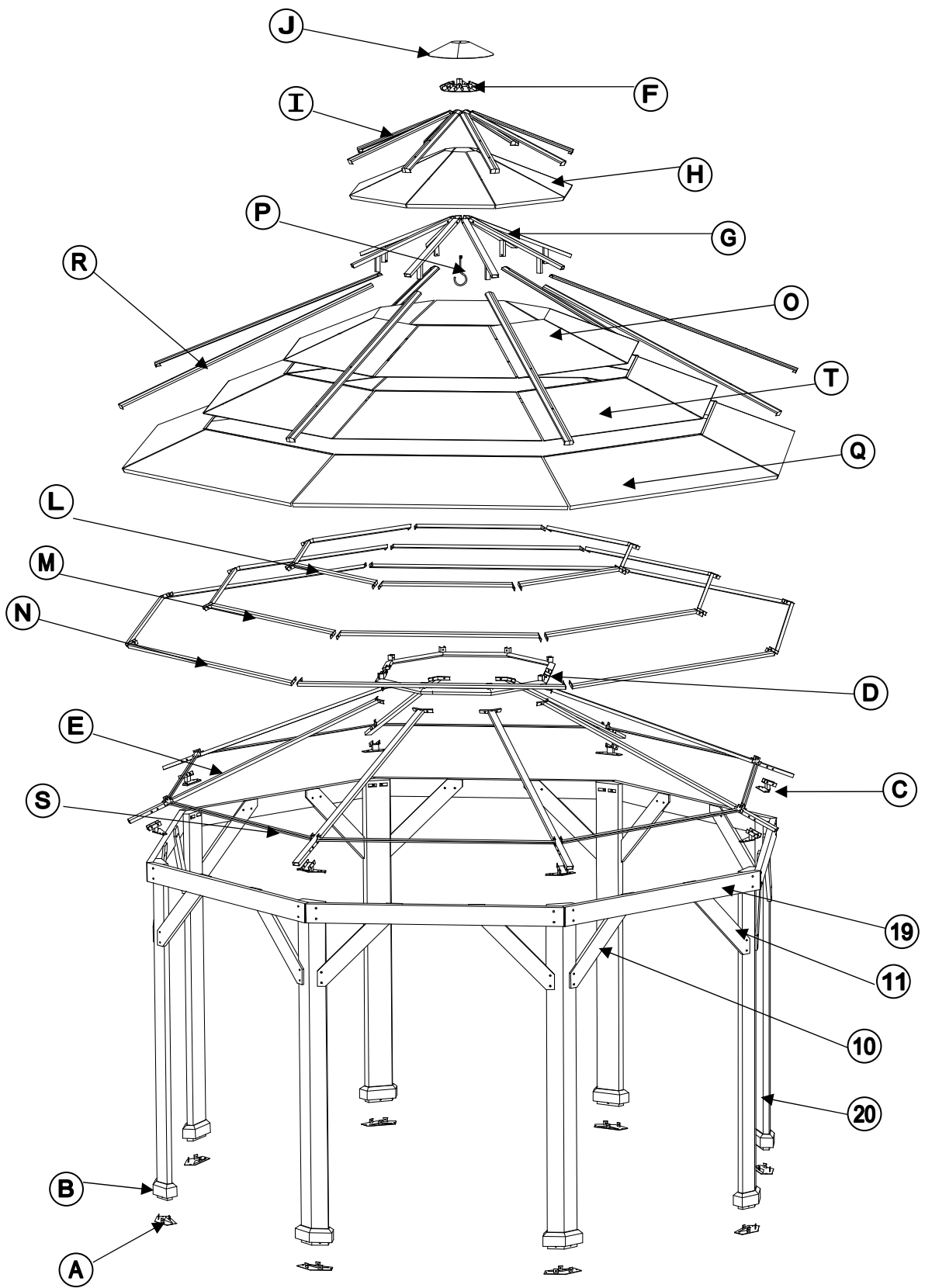

**WICHTIG / IMPORTANT**

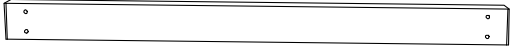
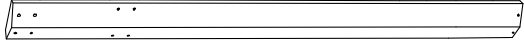
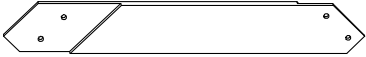
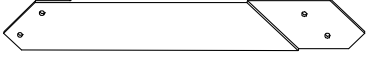
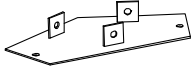
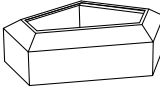
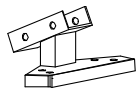



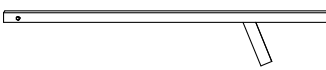
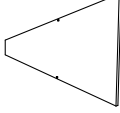
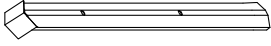

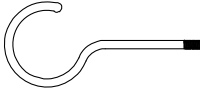
Benötigte Personen für Aufbau / People needed for installation work.





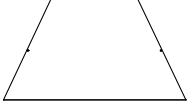

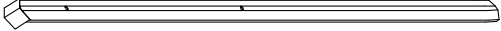

## TEILELISTE / PARTS LIST

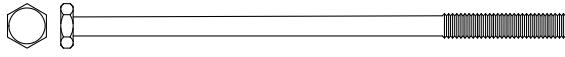
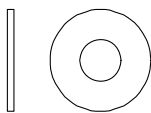
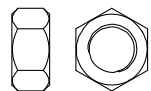
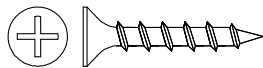
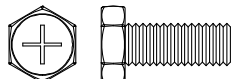
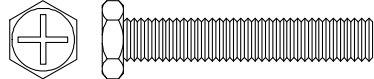
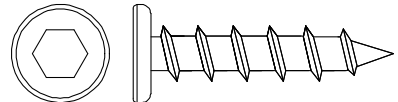
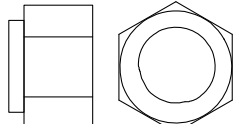
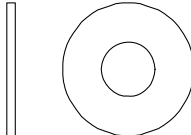
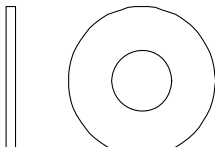
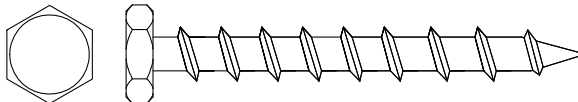
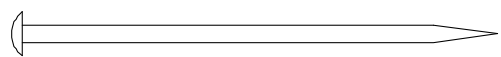
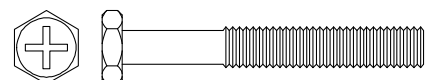
Label	Part Number	Qty	Part Image
19	P000400931	8	
20	P000200482	8	
10	P005000200	8	
11	P005000201	8	
A	P000100342	8	
B	P006100179	8	
C	P000501238	8	
D	P000501237	2	
E	P000601432	8	
F	P000501239	1	
G	P000601436	8	
H	P000700640	8	
I	P000800252	8	
J	P000900102	1	
P	P005800001	1	
L	P000601435	8	

Label	Part Number	Qty	Part Image
M	P000601434	8	
N	P000601433	8	
O	P000700637	8	
T	P000700638	8	
Q	P000700639	8	
R	P000800251	8	
S	P005700694	8	

Label	Part Number	Description	Qty	Add	Part Image
AA	H010010306	M10*95	16	1	
BB	H050030001	M6	237	12	
CC	H040010004	M6	24	2	
DD	H030050058	ST4.8*30	56	3	
EE	H010020011	M6*15	156	8	
FF	H010020022	M6*40	33	2	
GG	H030030010	ST8*35	64	4	
HH	H040050020	M10	16	1	
II	H050080007	M8	64	4	
JJ	H050080008	M10	48	3	
KK	H010010285	M10*65	16	1	
LL	H070010003	Φ8*180	16	0	
MM	H010020025	M6*60	24	2	

Label	Part Number	Description	Qty	Add	Part Image
NN	H090990002	M3	2	0	
Z1	H090010017	M6	2	0	
Z2	H090030005	M8	2	0	
Z3	H090010015	M10	2	0	

# 1

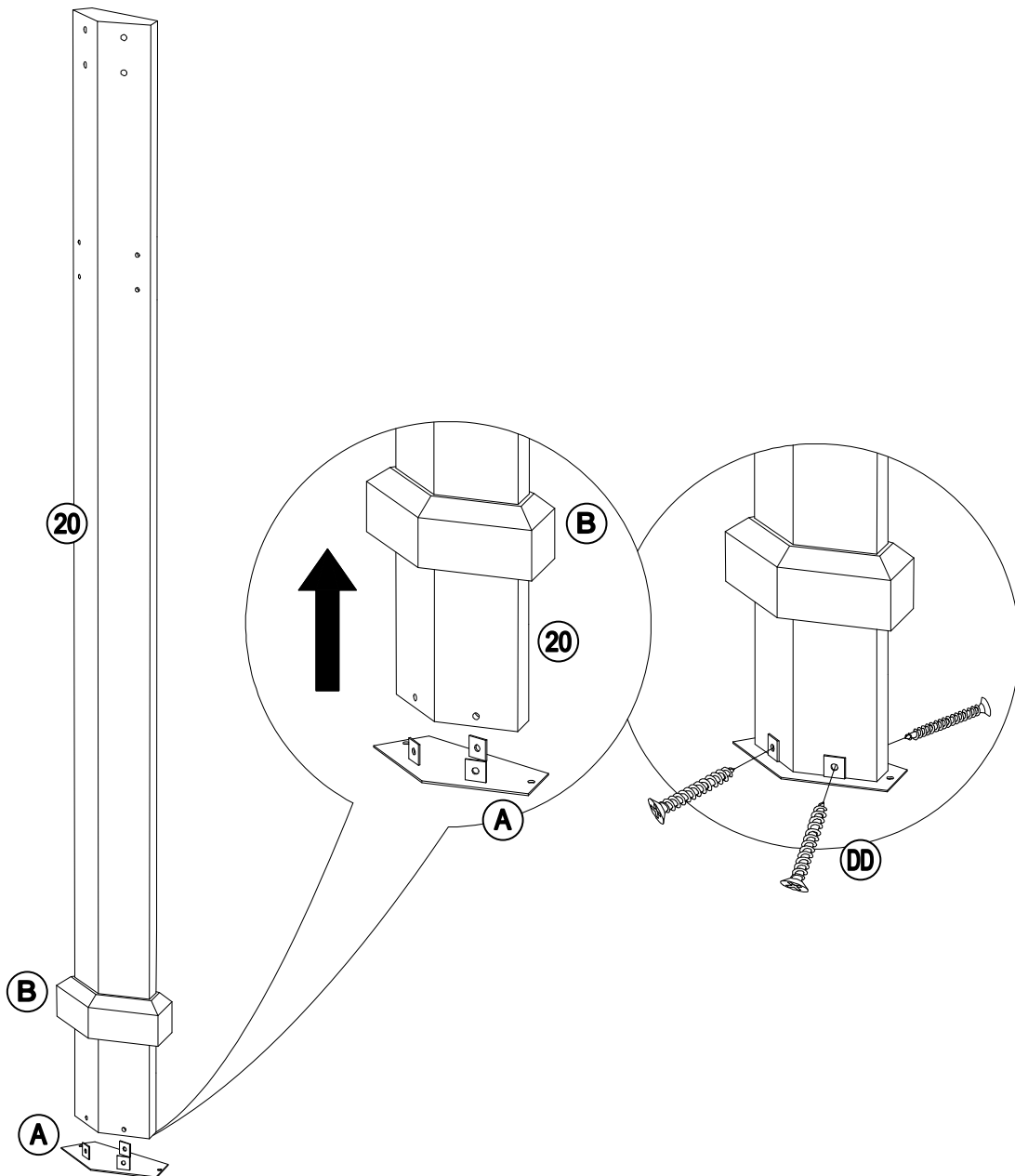
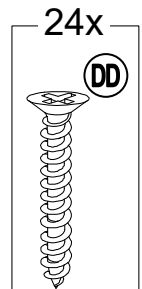
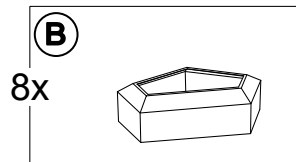
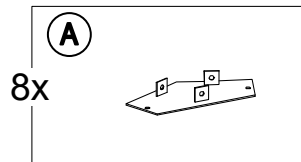
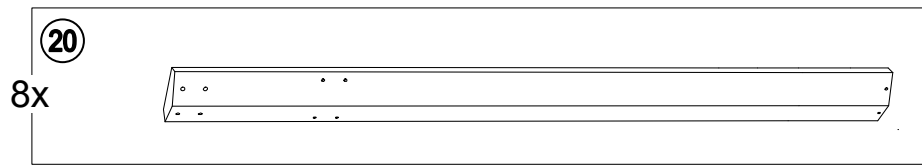



# 3

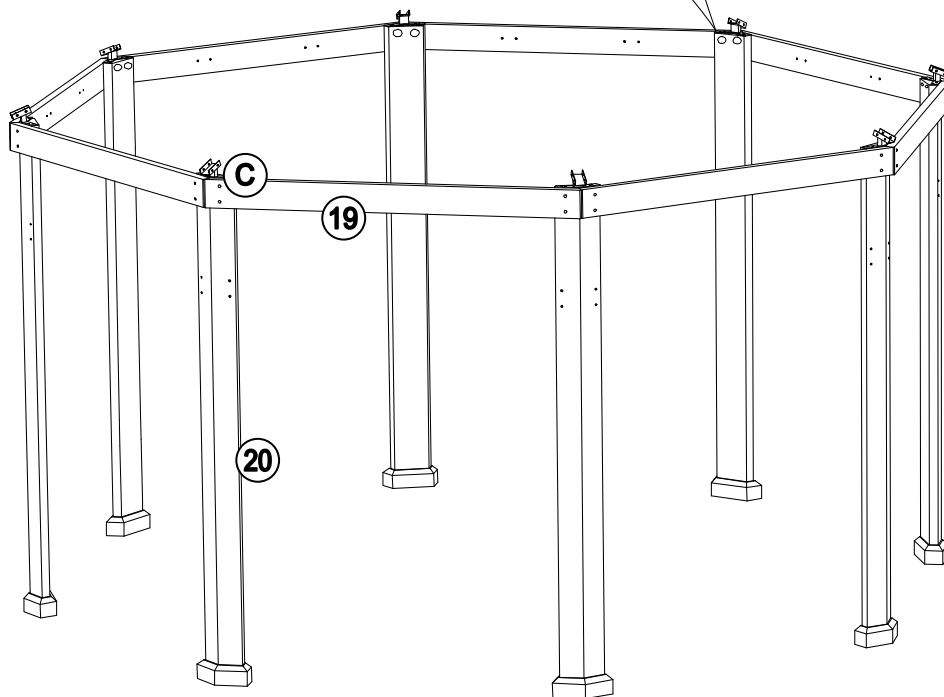
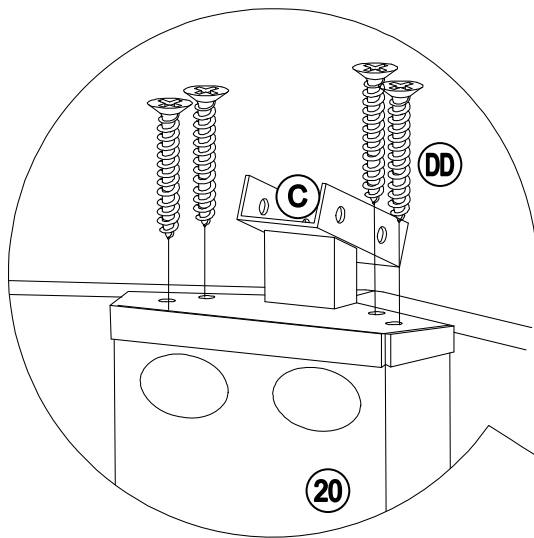
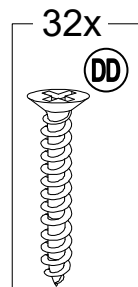
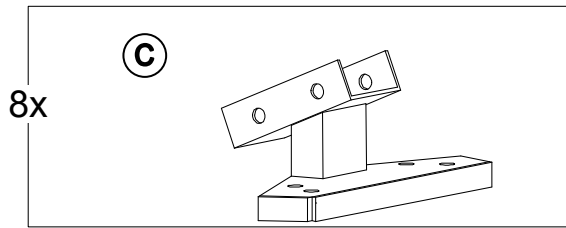

# 4

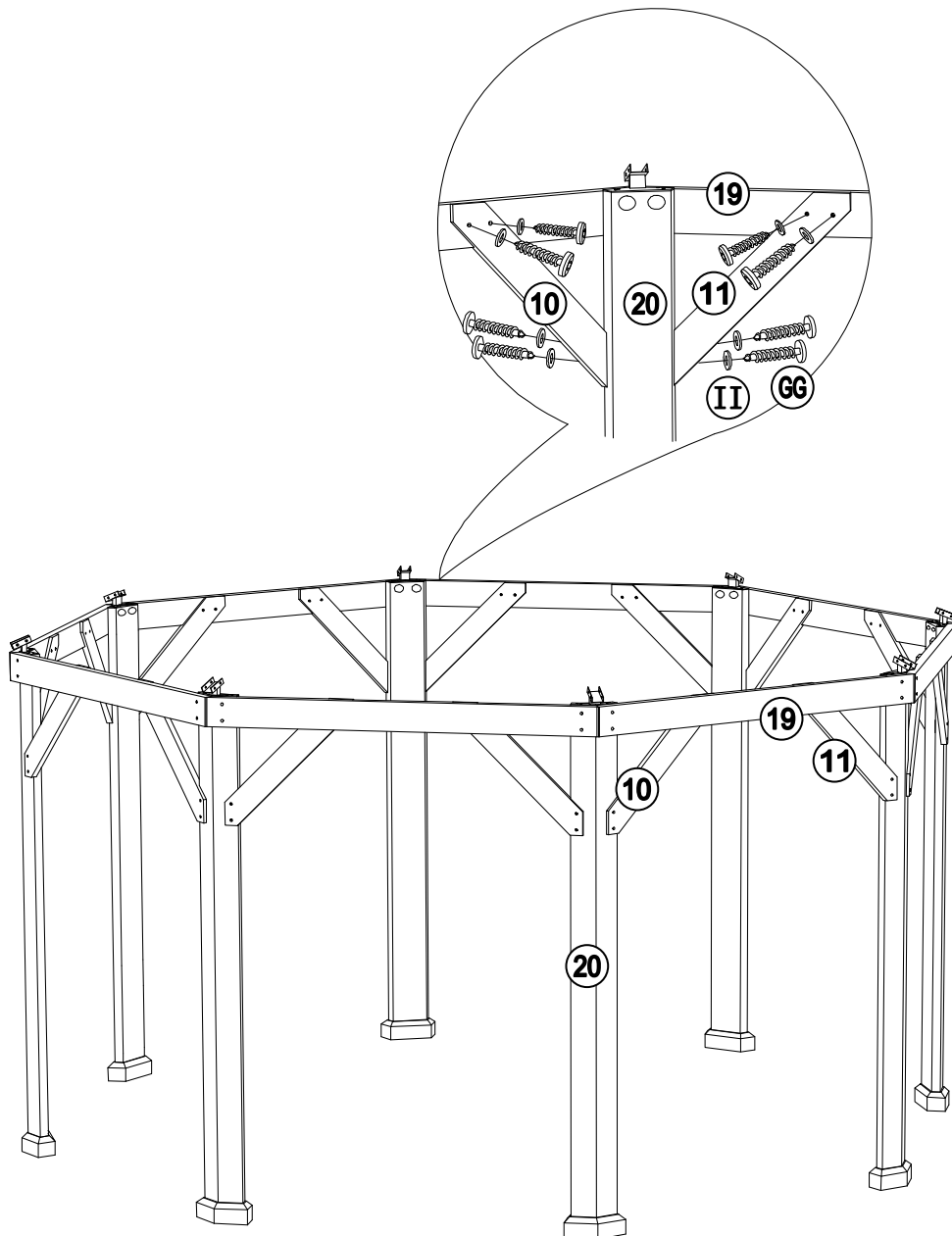
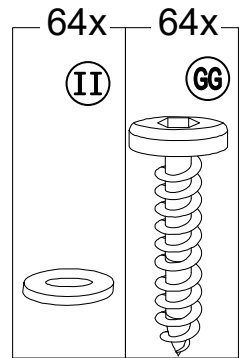
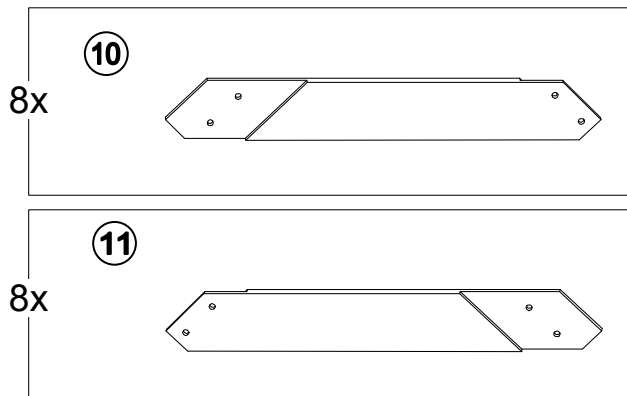



# 6

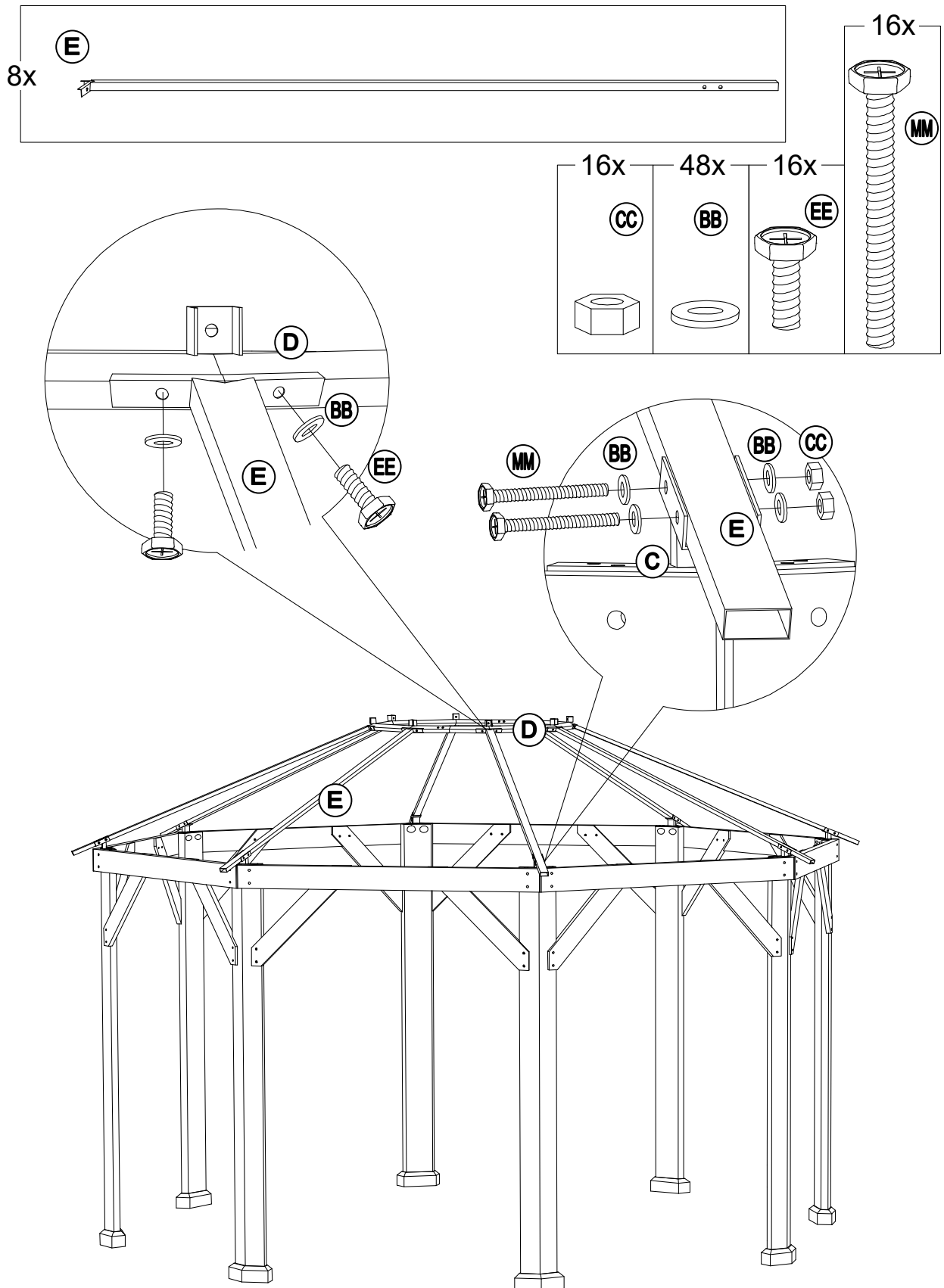

# 7

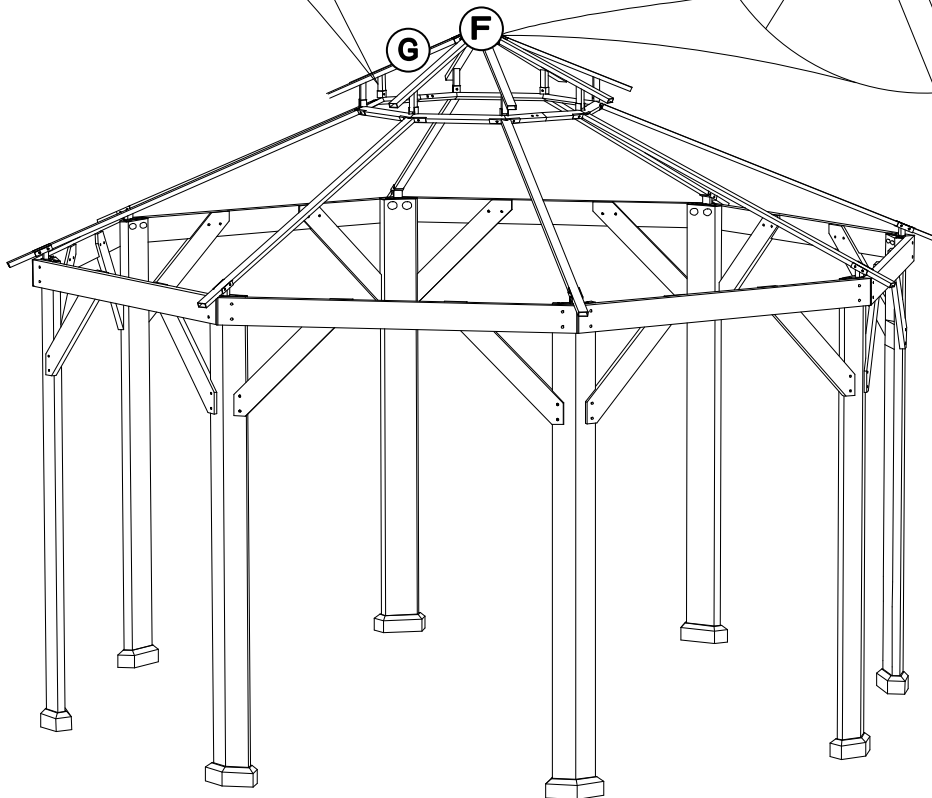
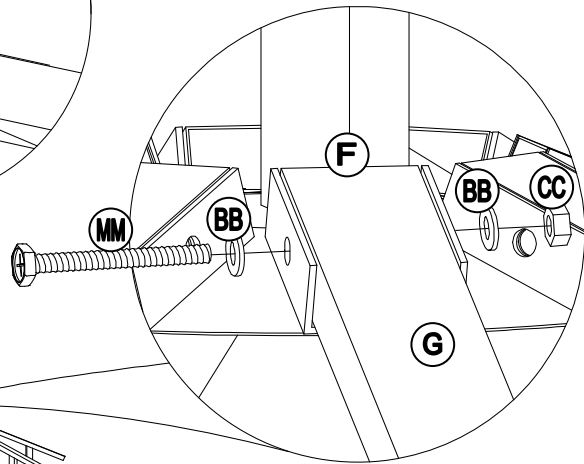
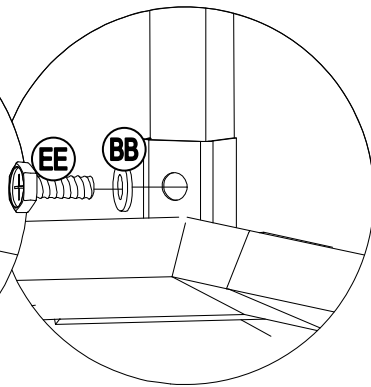
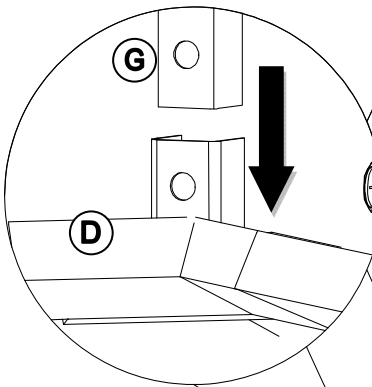
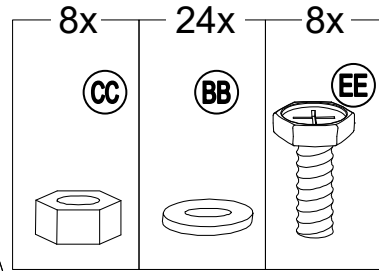
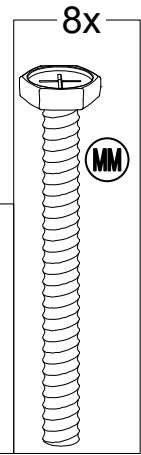
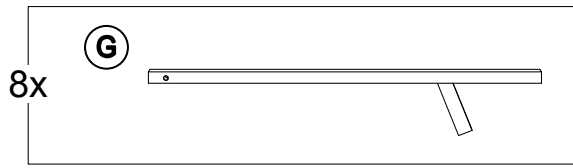
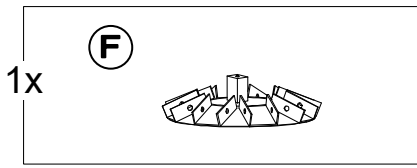

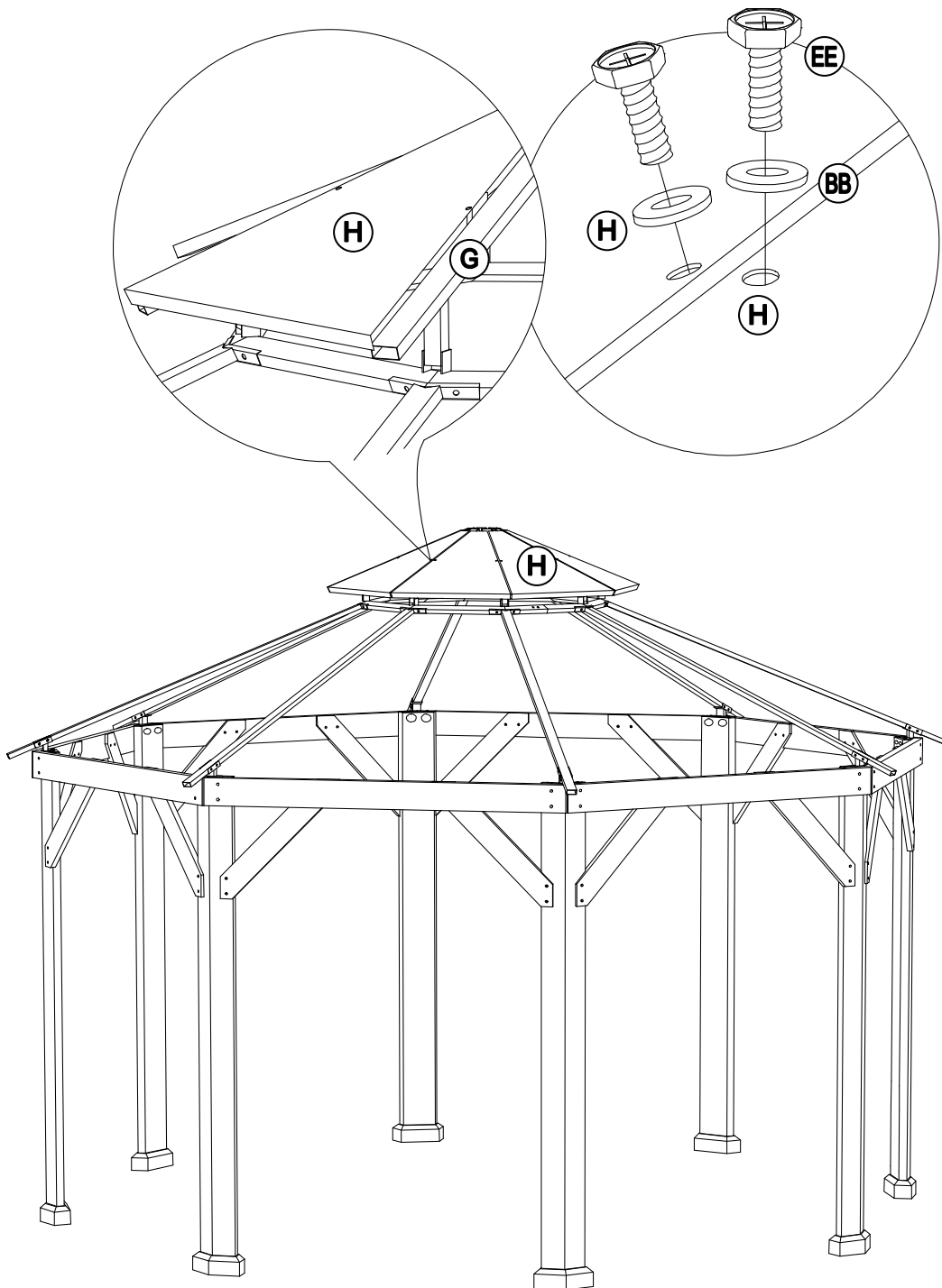
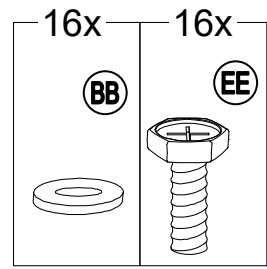
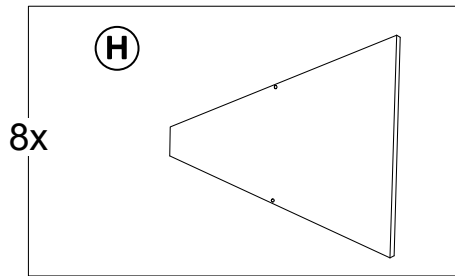

9

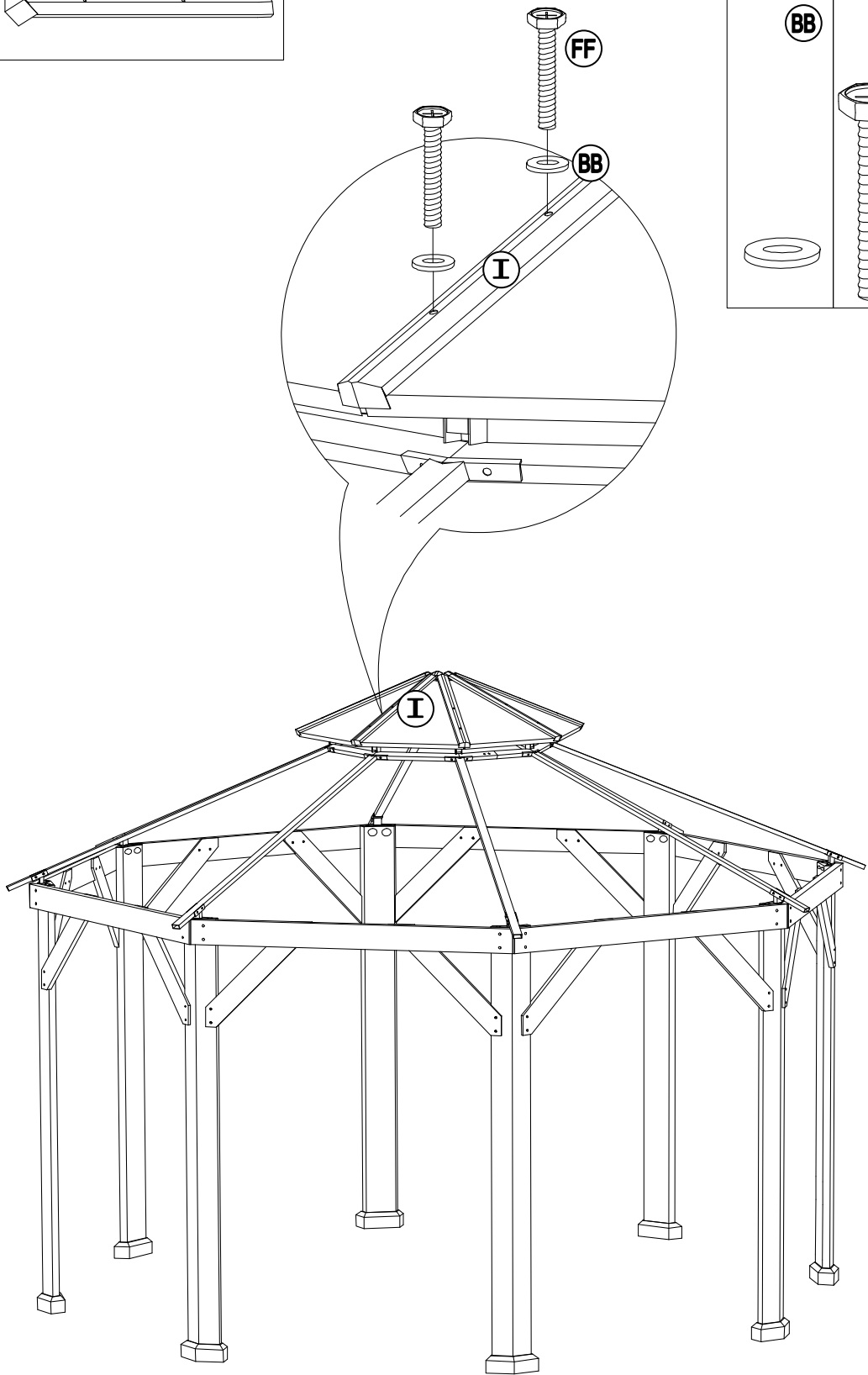
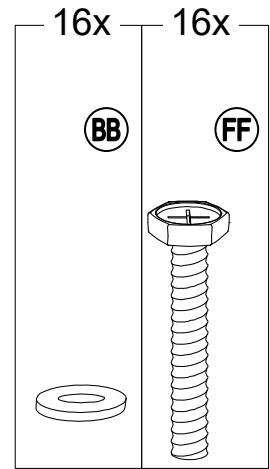
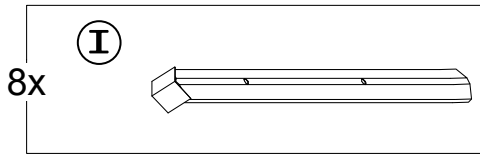

# 10

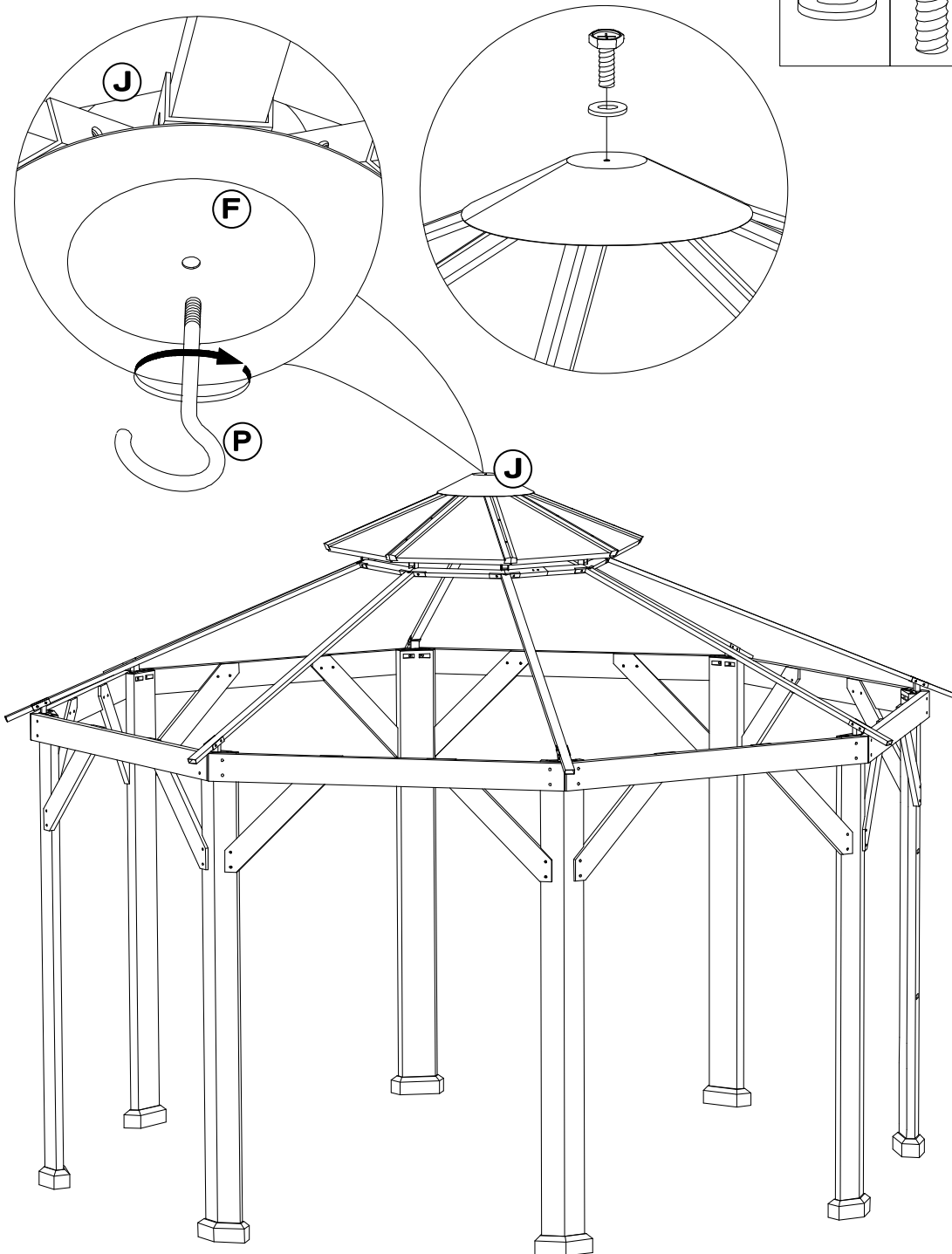
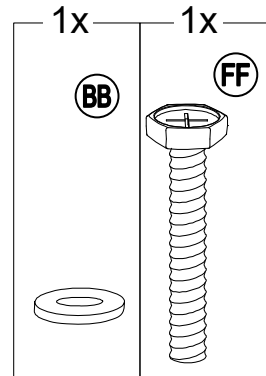
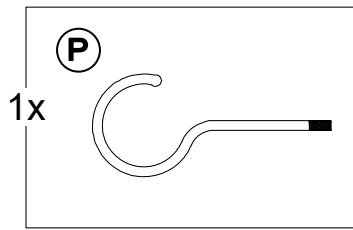
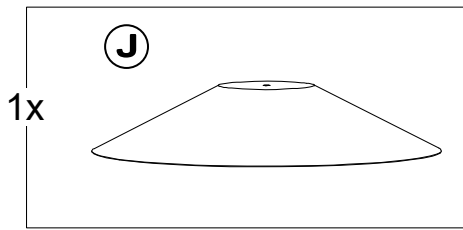

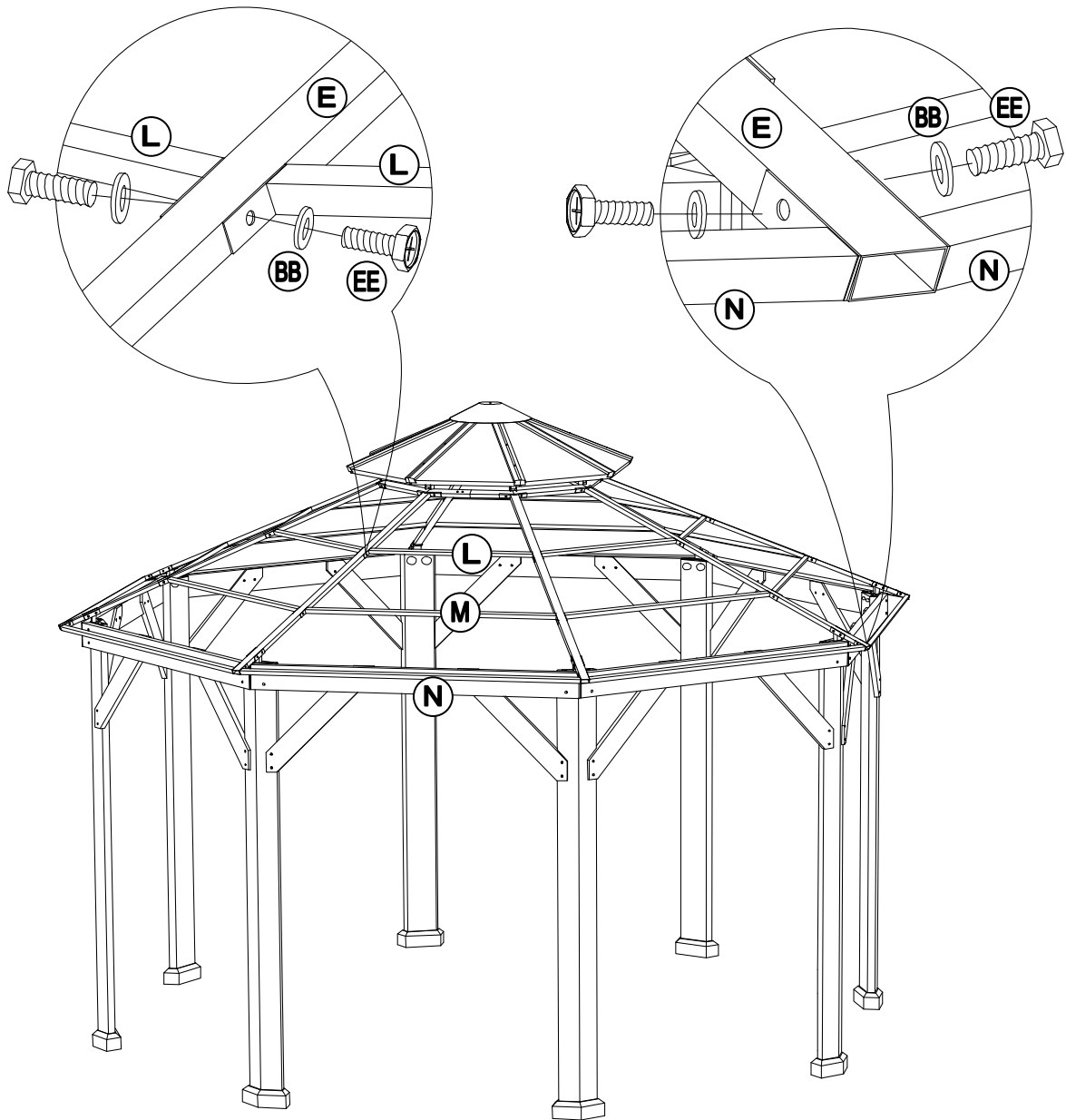
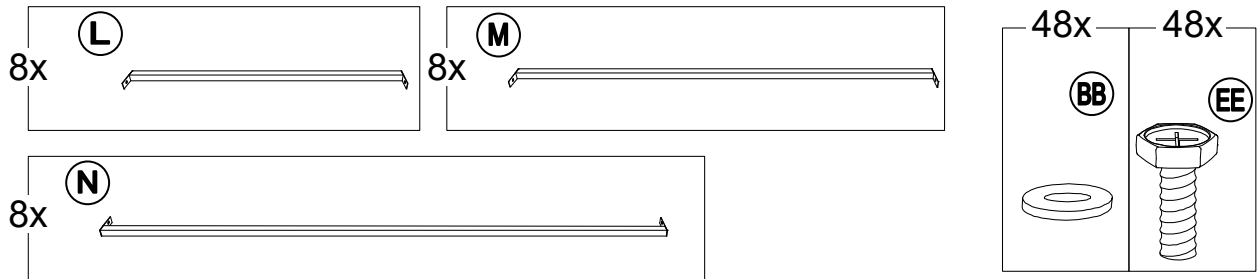

# 12

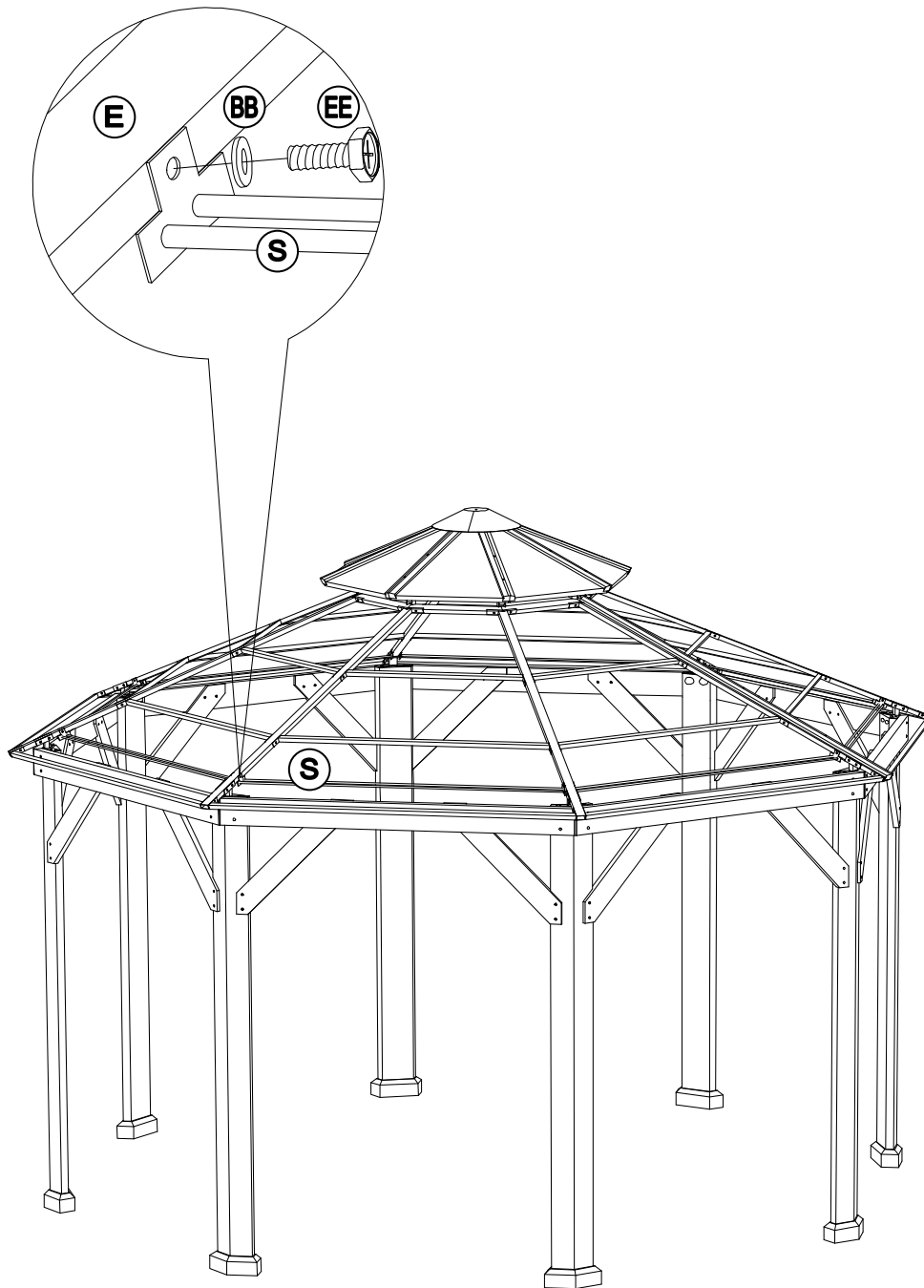
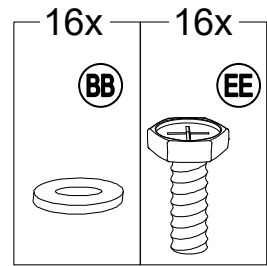
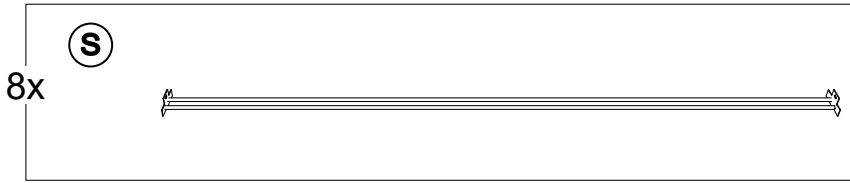

# 13

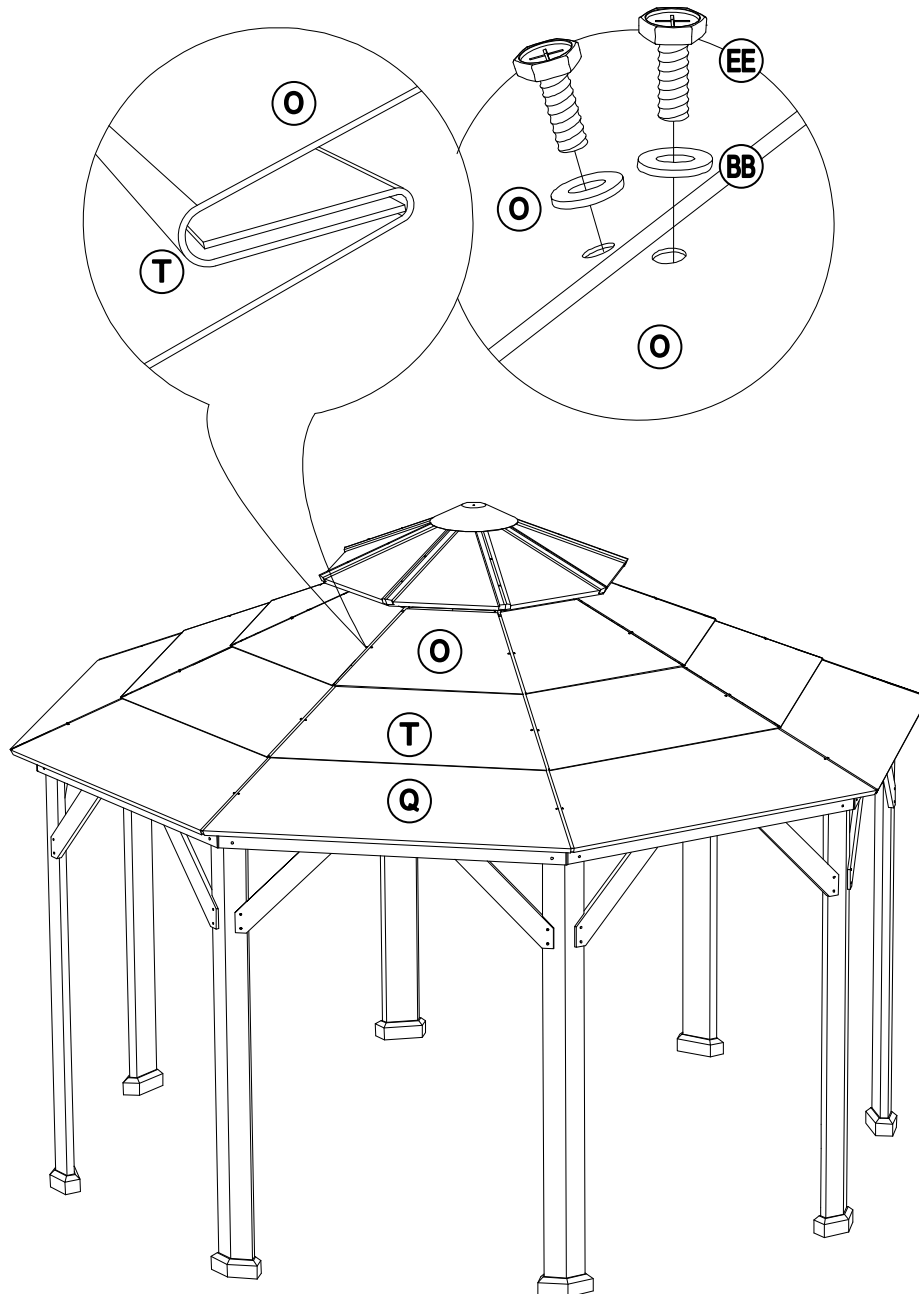
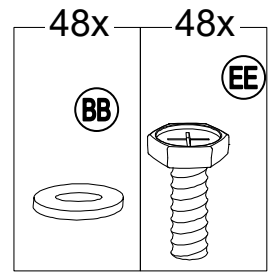
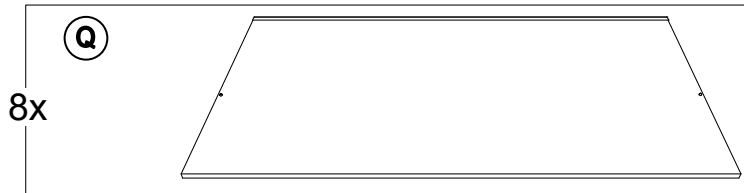
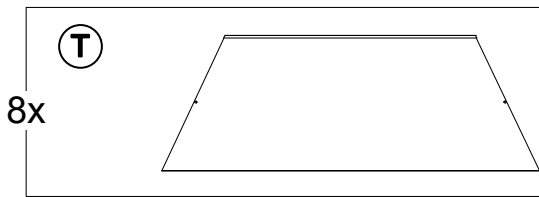
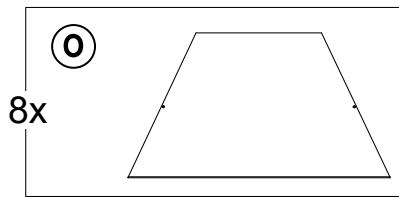

# 14

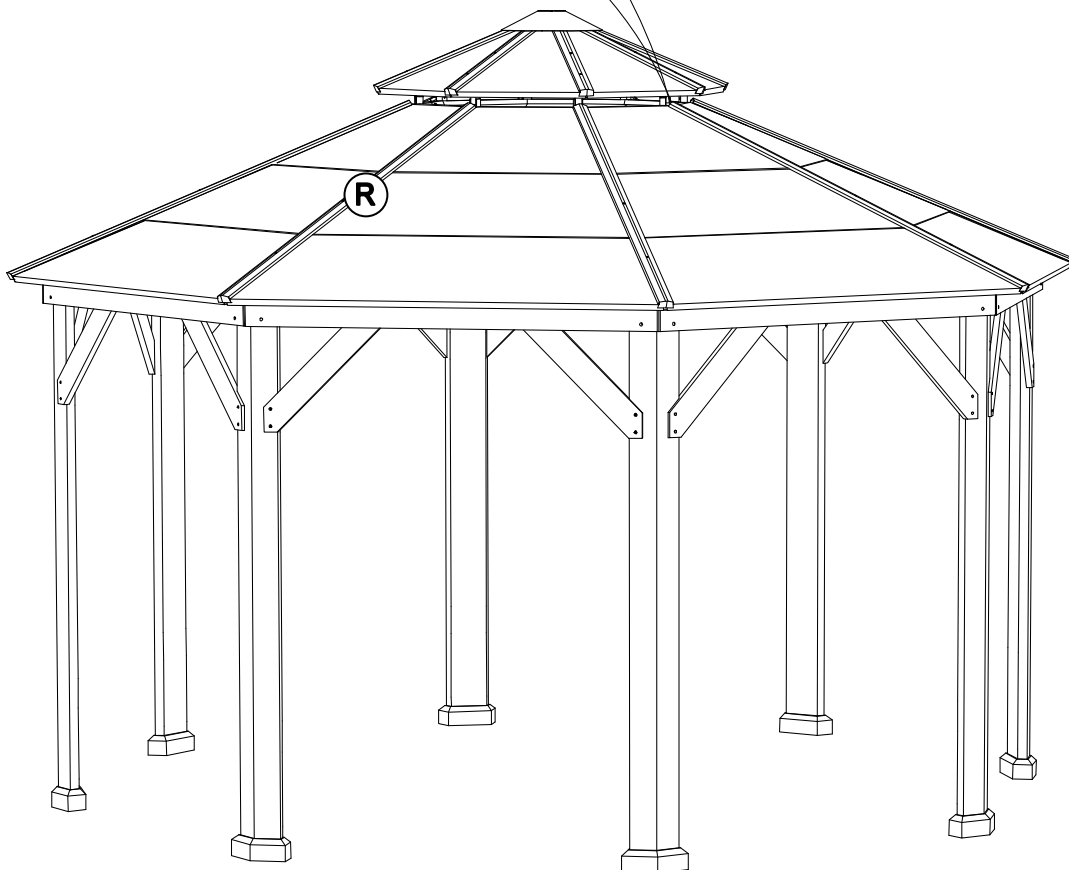
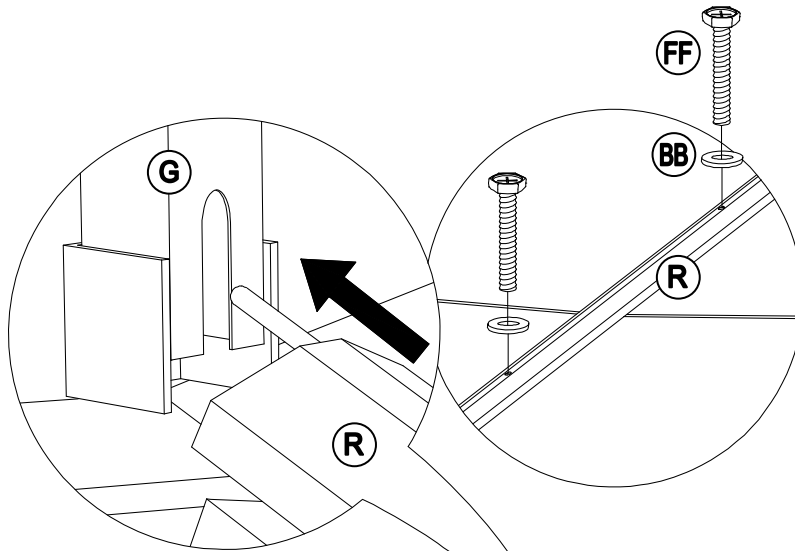
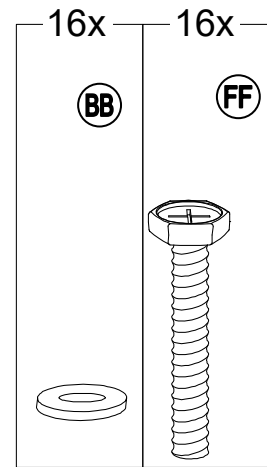
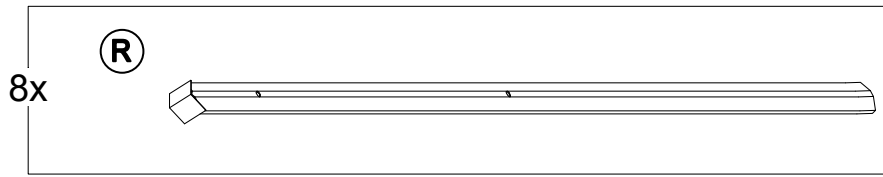

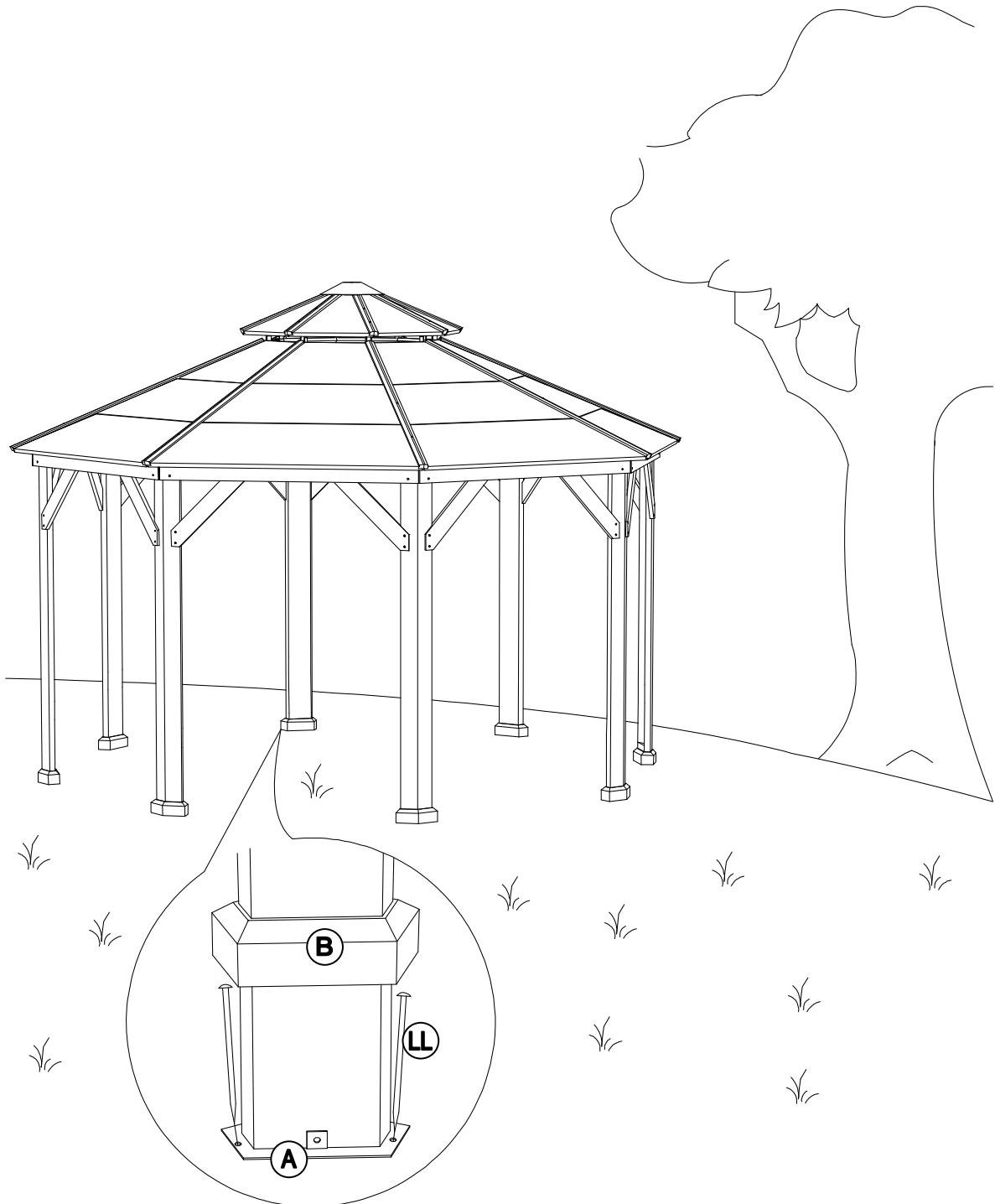
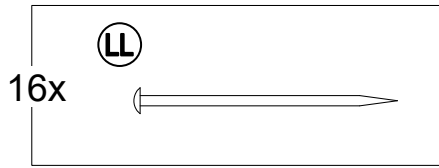



**SunWay Europe GmbH**

Wrangelstraße 100

10997 Berlin

Germany

E-Mail: [helpme@sunjoyonline.eu](mailto:helpme@sunjoyonline.eu)

[www.sunjoyonline.eu](http://www.sunjoyonline.eu)