

ASSEMBLY INSTRUCTION

A middle sofa 2PC

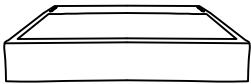

Bsofa-L 1PC



Csofa-R 1PC

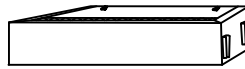

T ottoman 2PCS

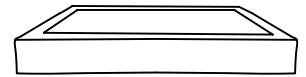

Ycushion cover 4PCS

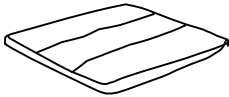

Jcushion cover-OTT 2PCS

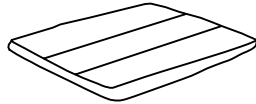

KCushion foam 4PCS

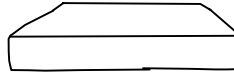

LCushion foam-OTT 2PCS



E Armrest-L 1PC

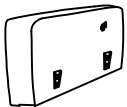

F Armrest-L 1PC



G Backrest-L 1PC

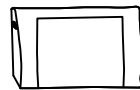

HBackrest-R 1PC

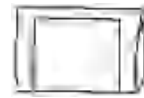

DBackrest-Middle 2PCS

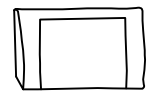

N Leg 24 PCS



M Connect metal 8pcs



O Cushion 4PCS

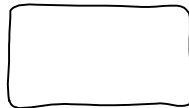

P pillow 2PCS

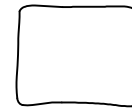

S Velcro 18PCS

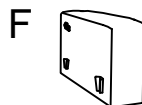
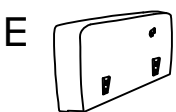
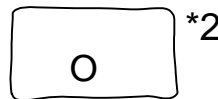
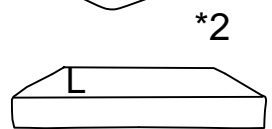
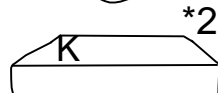
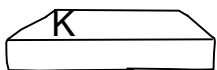
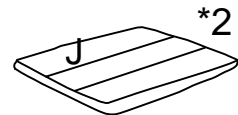
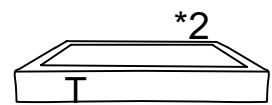
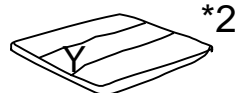
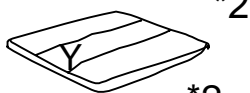
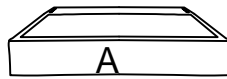
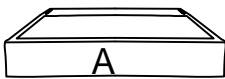
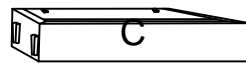
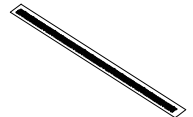

BOX-1

BOX-2

BOX-3

ASSEMBLY INSTRUCTION

STEP 1

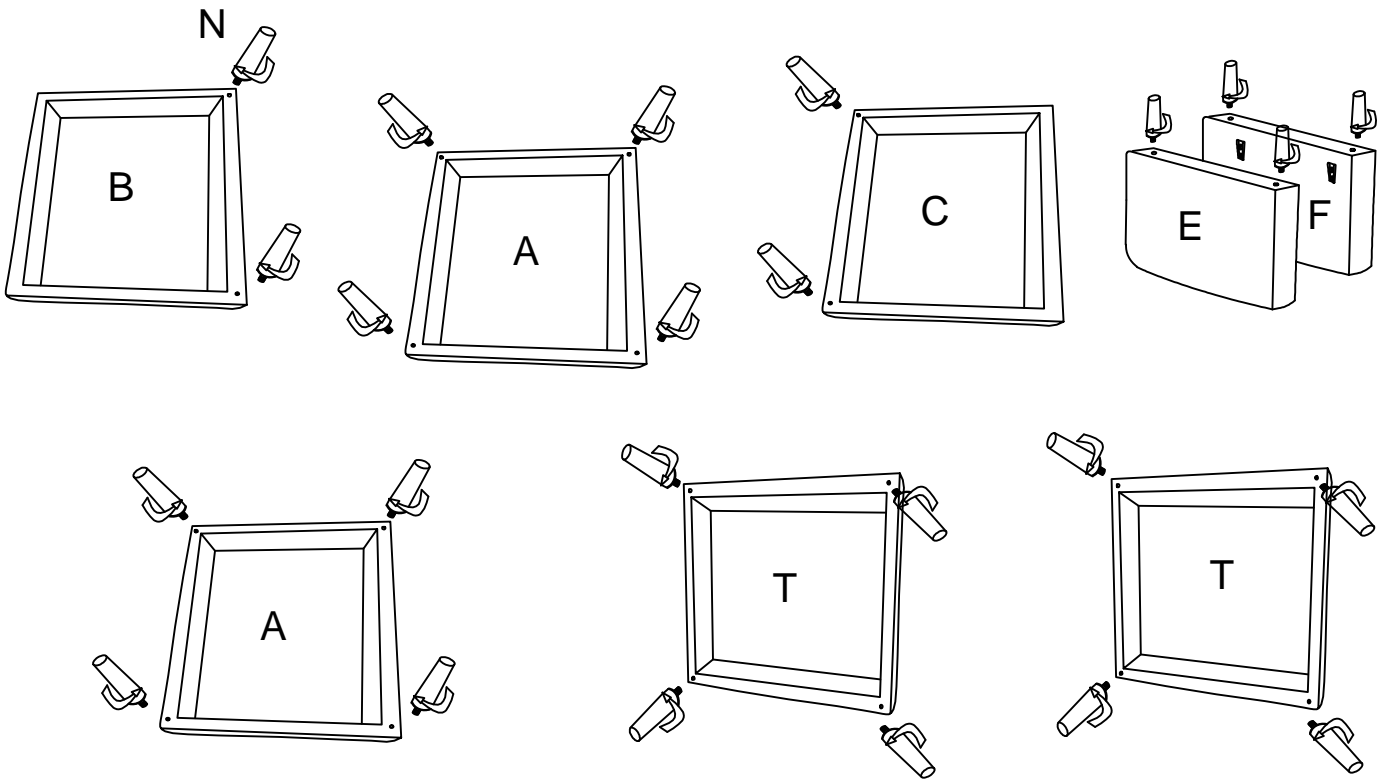

STEP 2

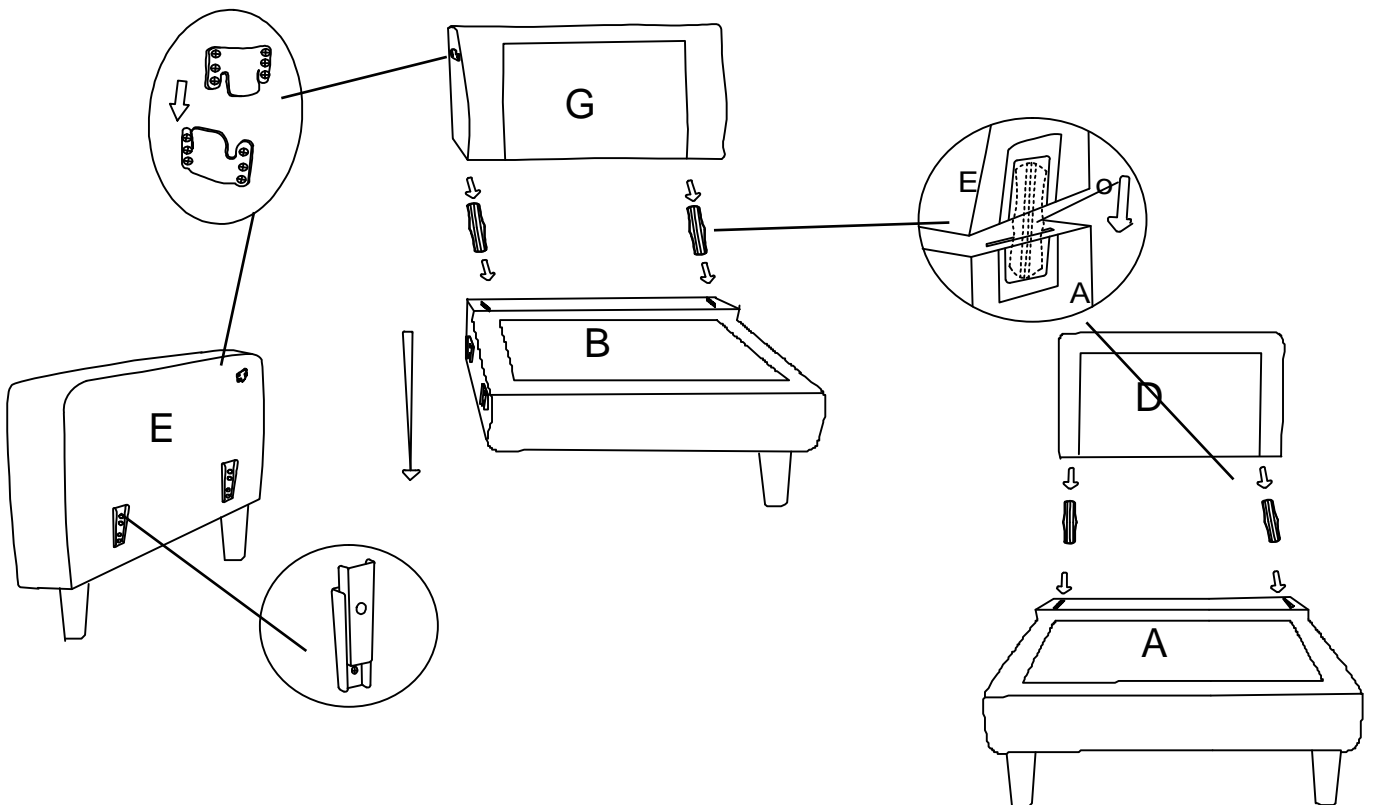

ASSEMBLY INSTRUCTION

STEP 3

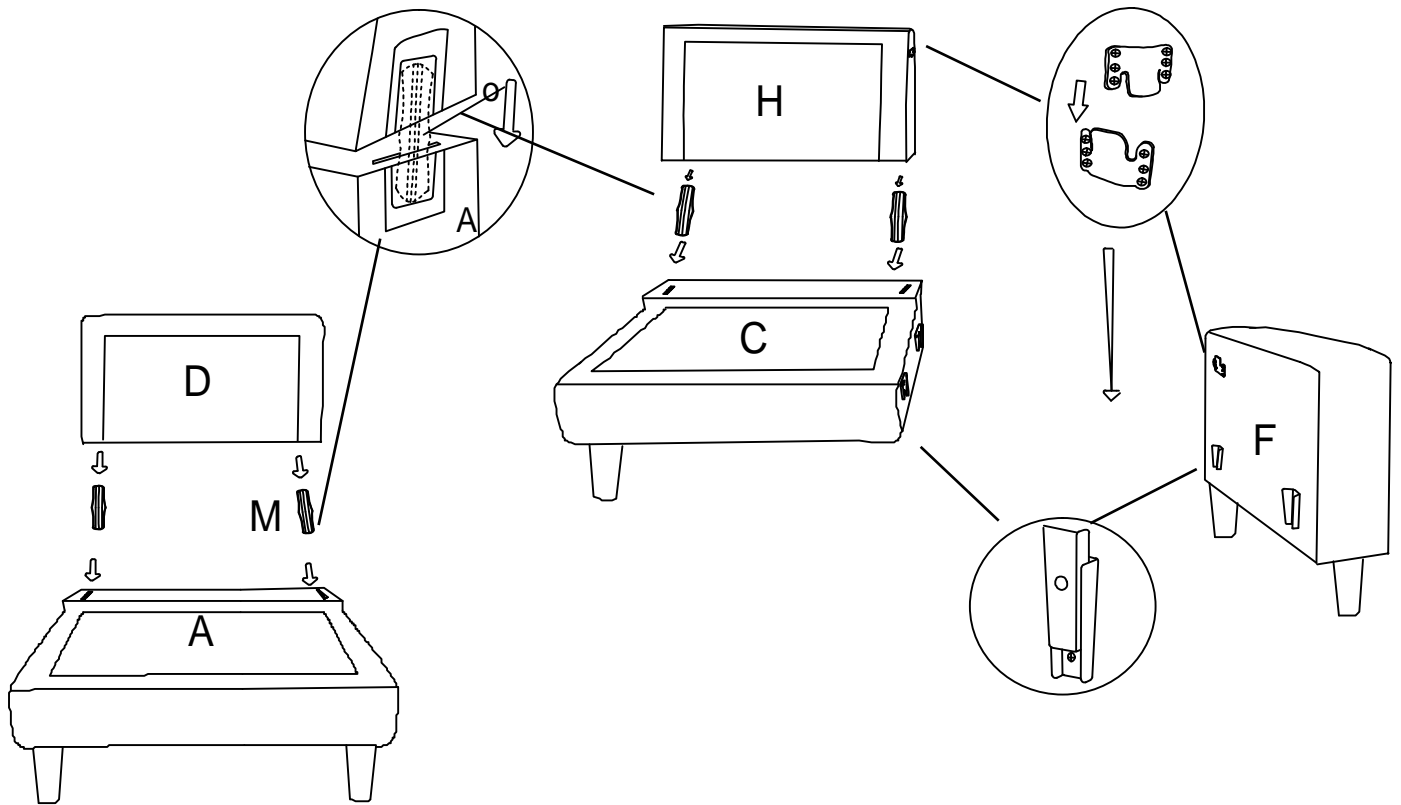

STEP 4 Secure it in place by using velcro

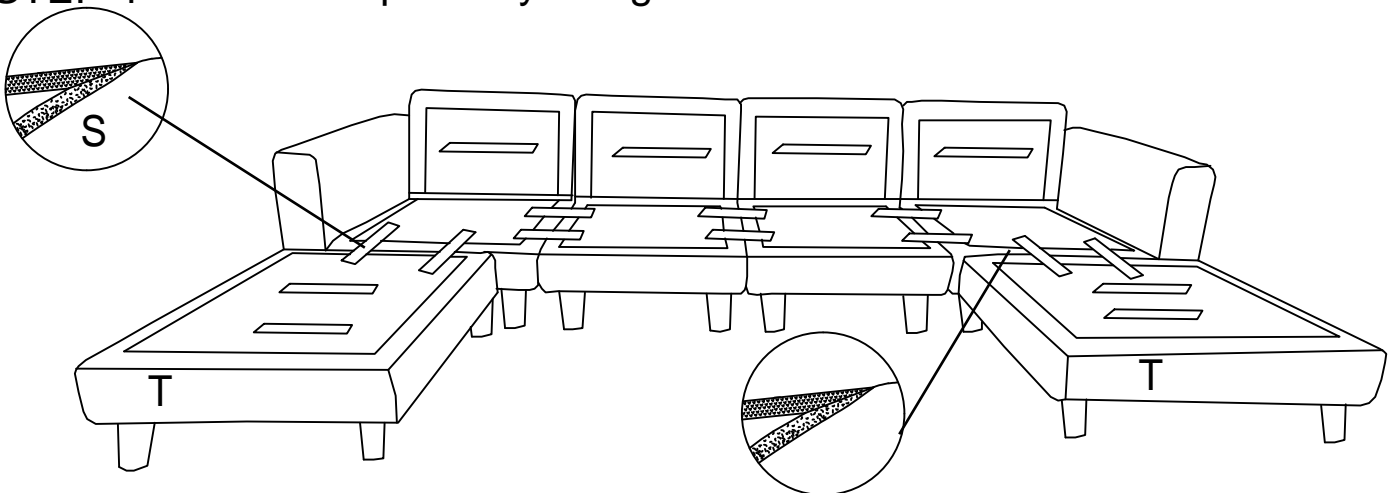

Put seat cushion foam inside of fabric cover .

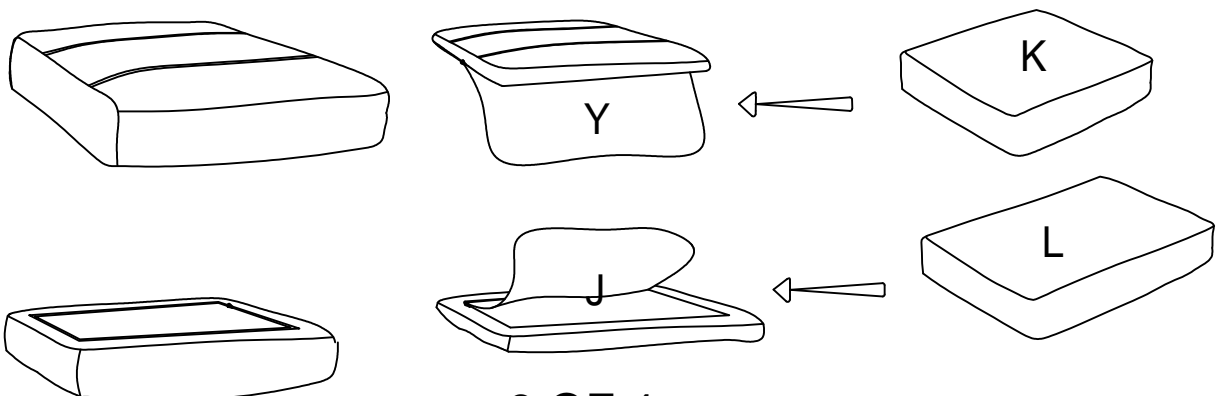

ASSEMBLY INSTRUCTION

STEP 5 After packing up, place them in somewhere dry and ventilated. After about 72-96hours. it can be restored to the best use condition.

1



Open the vacuum bag carefully.

2



Press and tap with both hands from the side to fully inhale air

3

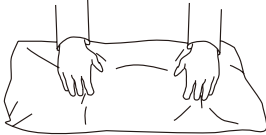

Press and tap with both hands from the front to fully inflate.

4

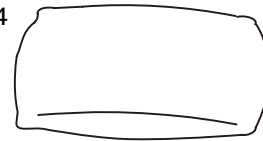

Carefully smooth out each section until the surface is even.

