

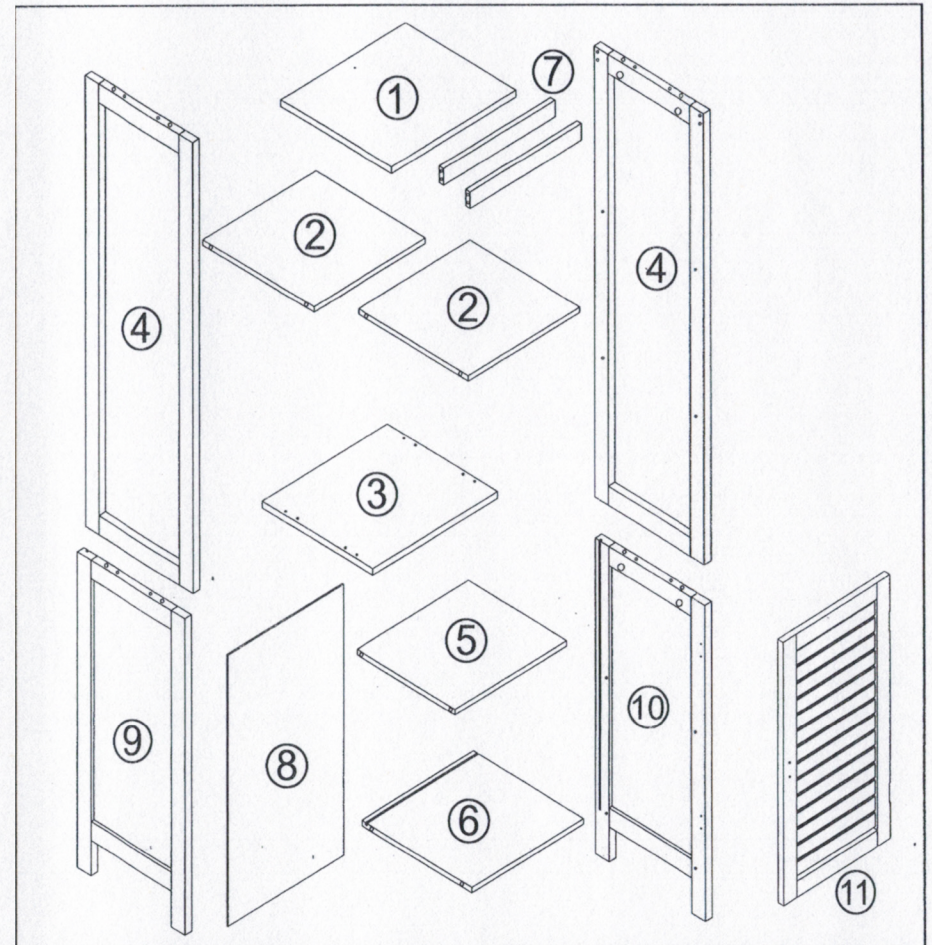

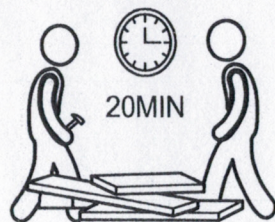

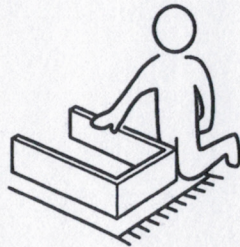

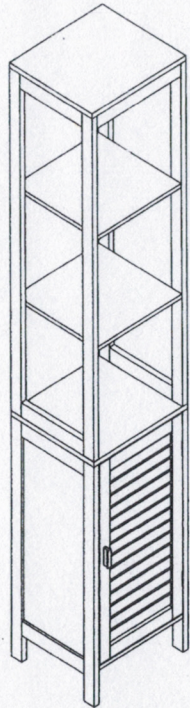









9901-704



Ax24  6x35mm	Bx24  15x10mm	Cx20  6x30mm	Dx6  3x14mm	Ex9  3x12mm	Fx5  4x35mm
Gx1 	Hx1 	Ix2 	Jx2  4x14mm	Kx4 	Lx1 
Mx1 	Nx1 	Ox8 	Px1 		

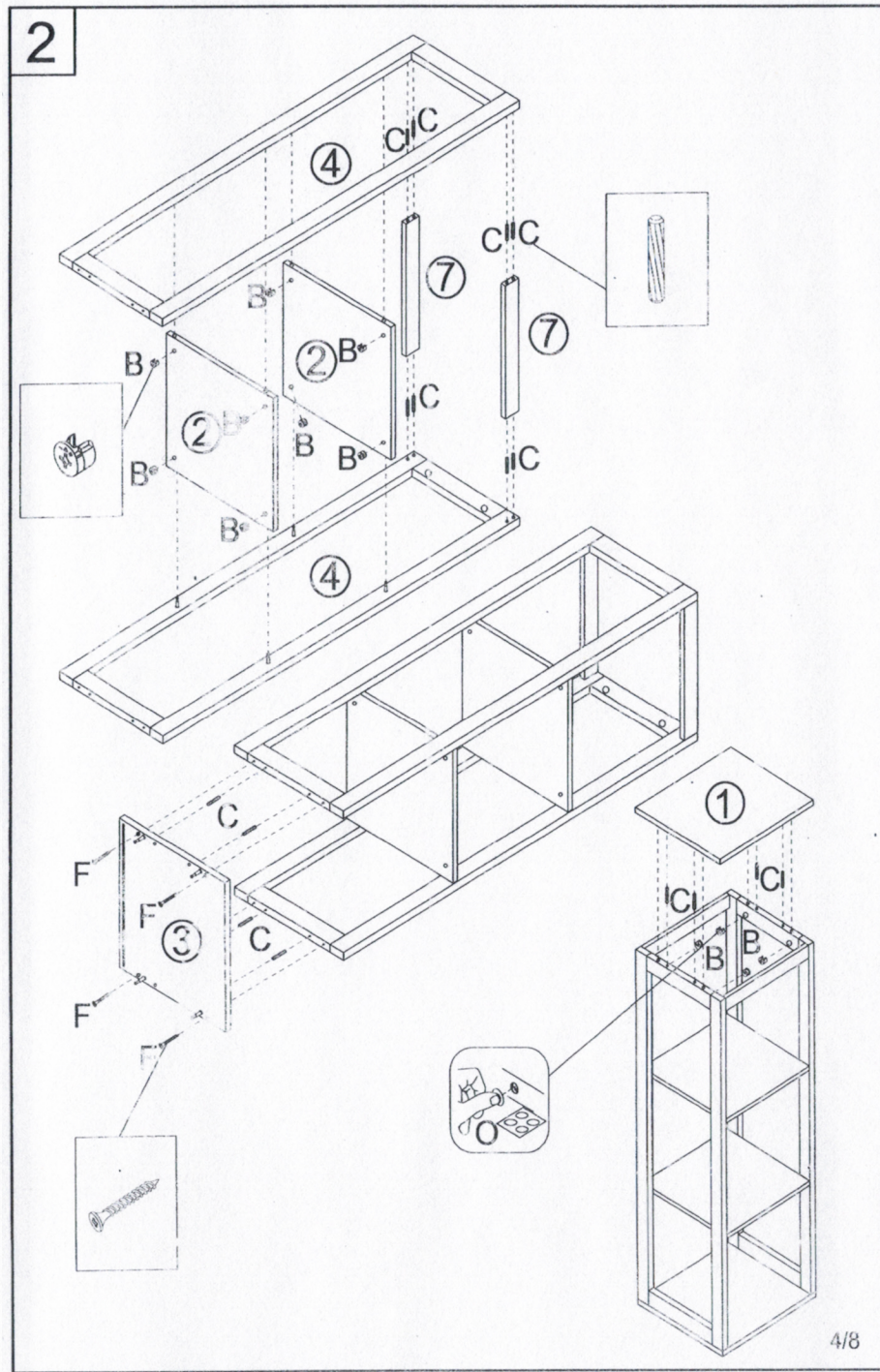
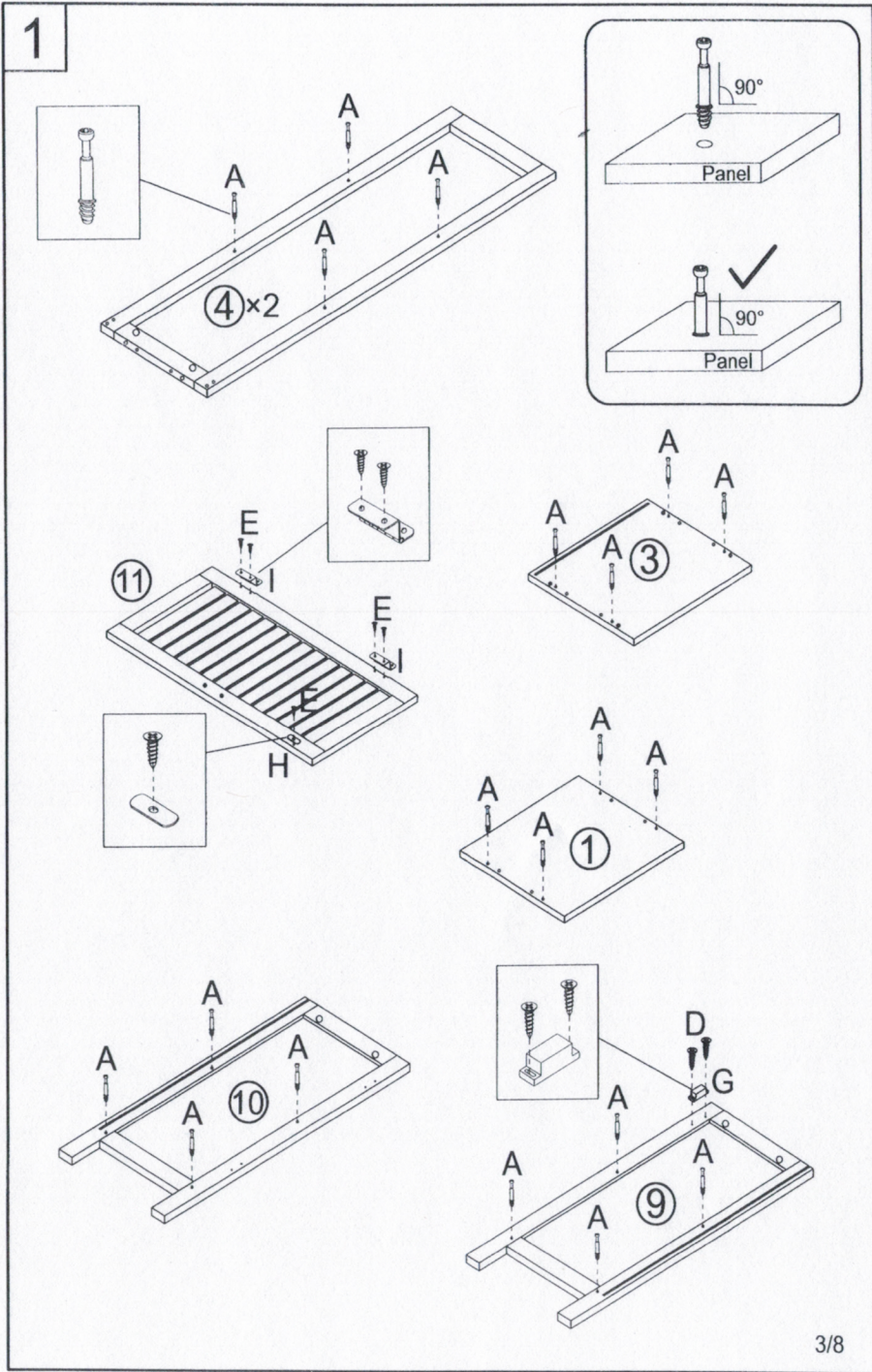

3

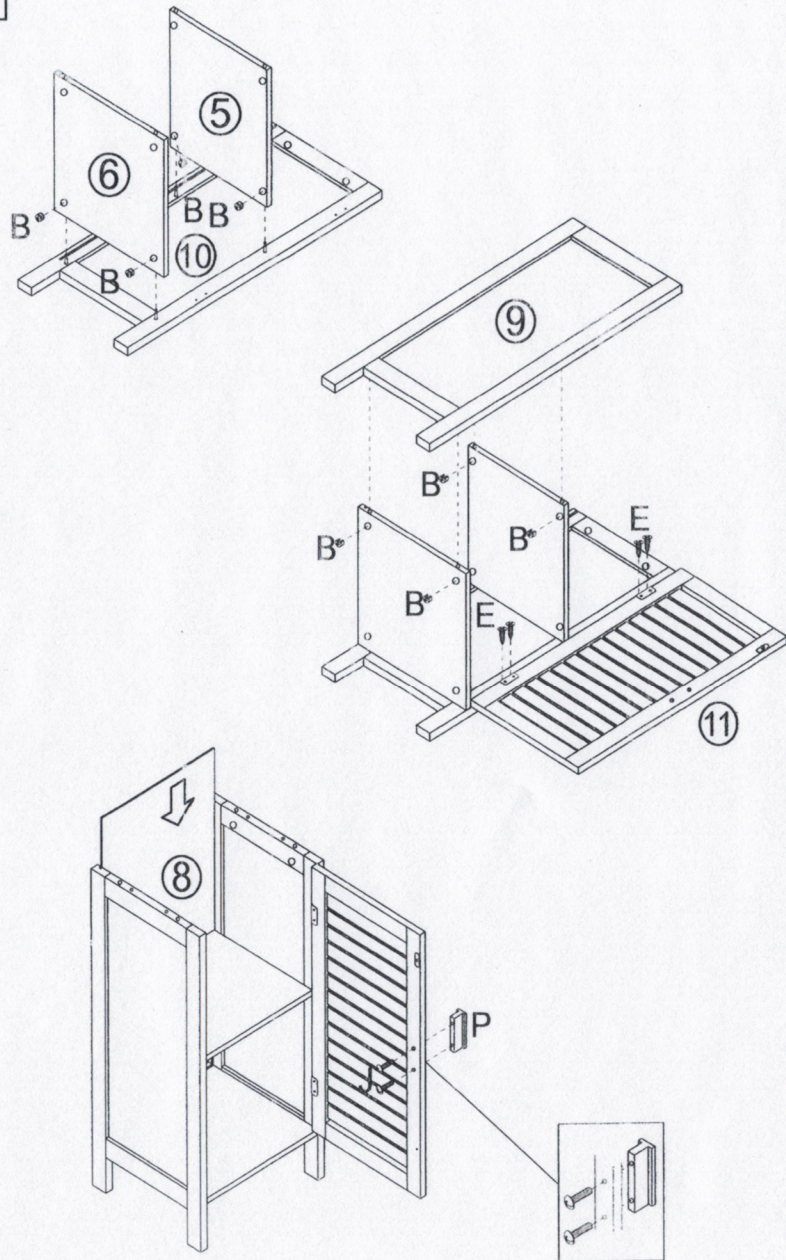

5/8

4

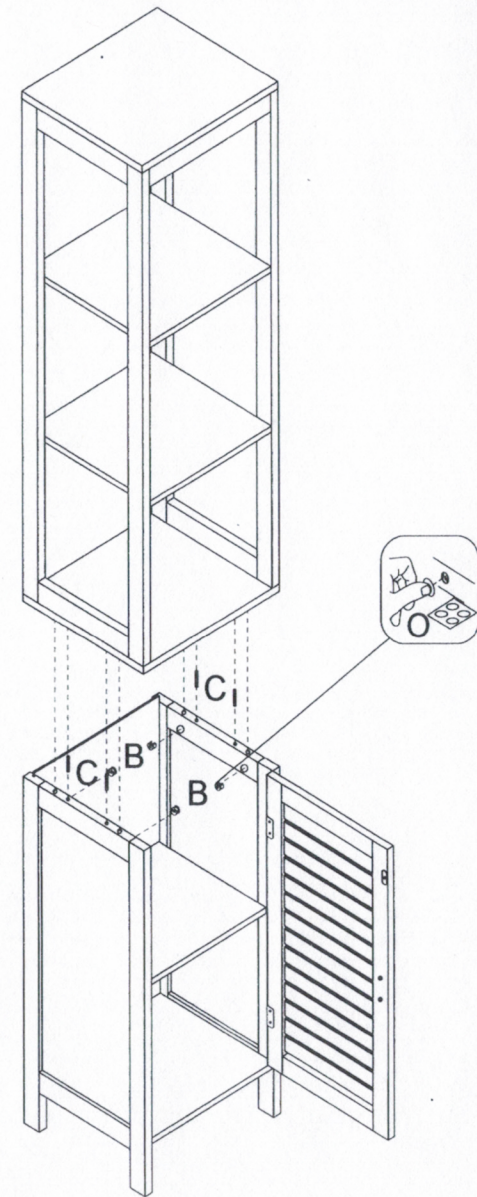

6/8

5

Avant de fixer "K", s'assurer que la dimension "XX=YY".
 Before fix "K", please make sure size "XX=YY".

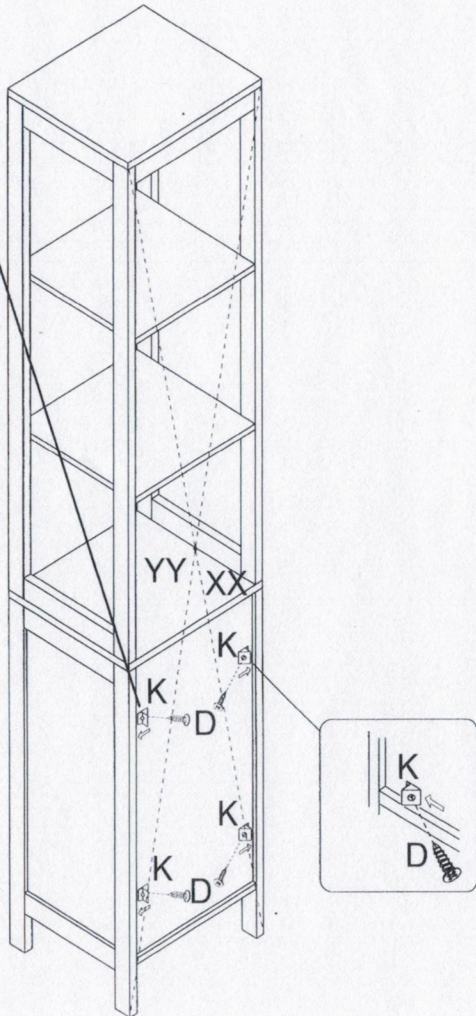

7/8

6

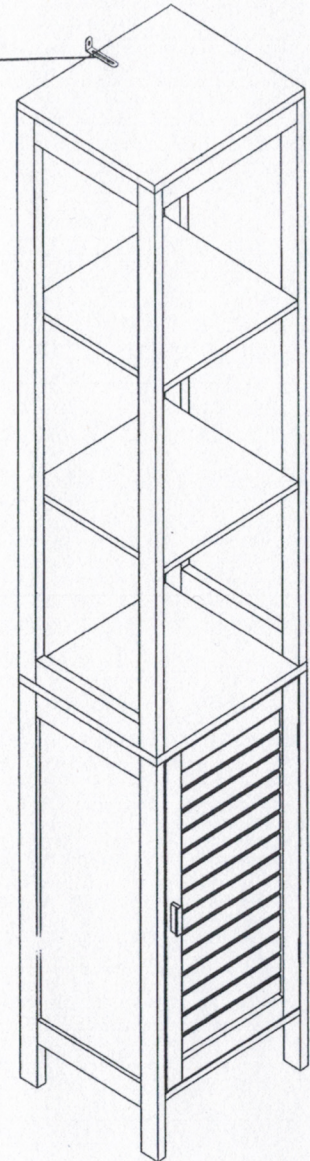
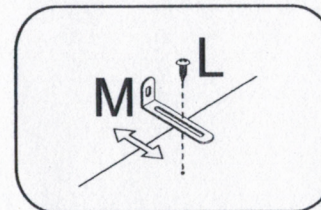
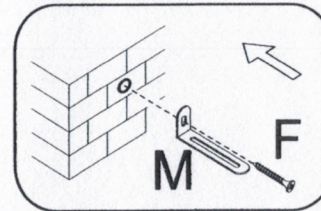
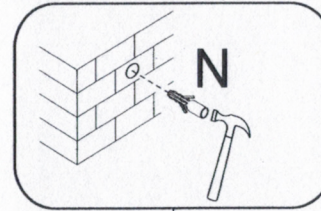
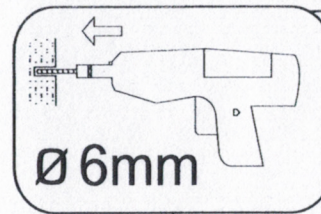

8/8