

ASSEMBLY INSTRUCTIONS

CHEST









NOTE TO CUSTOMERS:

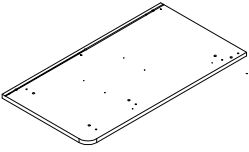
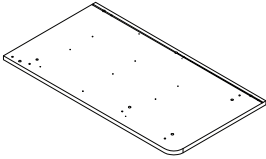
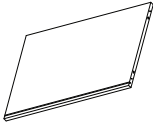



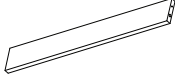
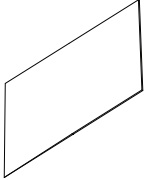
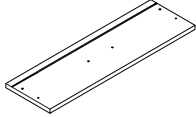
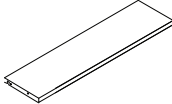
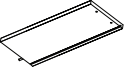

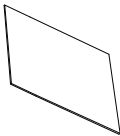
- For ease and speed of assembly we recommend that before you commence each step of the assembly that you identify all the parts required to complete that step.
- We recommend that where possible you allow sufficient space to assemble the item as close as possible to the place where it will be once assembled.
- For the protection of your furniture we recommend that the product is placed on a dry, soft, smooth and clean surfaces during assembly to prevent any damage. Avoid damp and direct sunlight.
- During assembly do not over tighten the screws or bolts, as this may damage the product.
- Please ensure you retain all the product packaging until the item is completely assembled.
- Periodically check all fitting and re-tighten as necessary.
- Never allow any liquids to remain on your furniture as absorption can cause the wood to warp or finish to de-laminate.
- It is recommended that this item should be assembled by two adults.

ASSEMBLY INSTRUCTIONS

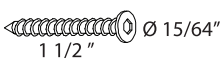
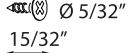
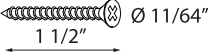
PARTS IDENTIFICATION

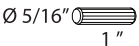
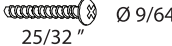
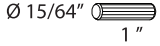
<p>P1 Quantity: 1</p>  <p>Side Panel-Left</p>	<p>P2 Quantity: 1</p>  <p>Side Panel-Right</p>	<p>P3 Quantity: 1</p>  <p>Top Panel</p>	<p>P4 Quantity: 1</p>  <p>Back Top Rail</p>	<p>P5 Quantity: 1</p>  <p>Back Middle Rail</p>
<p>P6 Quantity: 1</p>  <p>Back Bottom Rail</p>	<p>P7 Quantity: 3</p>  <p>Front Rail</p>	<p>P8 Quantity: 2</p>  <p>Back Panel</p>	<p>P9 Quantity: 3</p>  <p>Drawer Front</p>	<p>P10 Quantity: 3</p>  <p>Drawer Back</p>
<p>P11 Quantity: 3</p>  <p>Drawer Side- Left</p>	<p>P12 Quantity: 3</p>  <p>Drawer Side-Right</p>	<p>P13 Quantity: 3</p>  <p>Drawer Base</p>		

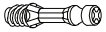
HARDWARE LIST

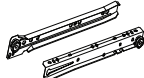
<p>H1 Flat Head Screw m6 x 40mm</p>  <p>Quantity: 16 pcs</p>	<p>H2 Screw m4 x 12mm</p>  <p>Quantity: 36 pcs</p>	<p>H3 Screw #9 x 1 1/2"</p>  <p>Quantity: 12 pcs</p>	<p>H4 Leg Stud</p>  <p>Quantity: 4 pcs</p>	<p>H5 Allen Key</p>  <p>Quantity: 1 pc</p>
<p>H6 Wooden Dowel m8 x 25mm</p>  <p>Quantity: 16 pcs</p>	<p>H7 Pan Head Screw #6 x 20mm</p>  <p>Quantity: 6 pcs</p>	<p>H8 Wooden Dowel m6 x 25mm</p>  <p>Quantity: 6 pcs</p>	<p>H9 Cam Lock 12/9.5mm</p>  <p>Quantity: 6 pcs</p>	<p>H10 Connecting Bolts</p>  <p>Quantity: 6 pcs</p>
<p>H11 Sticker</p>  <p>Quantity: 16 pcs</p>	<p>H12 Pull Handle</p>  <p>Quantity: 3 pcs</p>	<p>H13 Drawer Slider</p>  <p>Quantity: 3 sets</p>		

STEP 1 insert wooden dowels (H6) & (H8) into the following parts respectively.

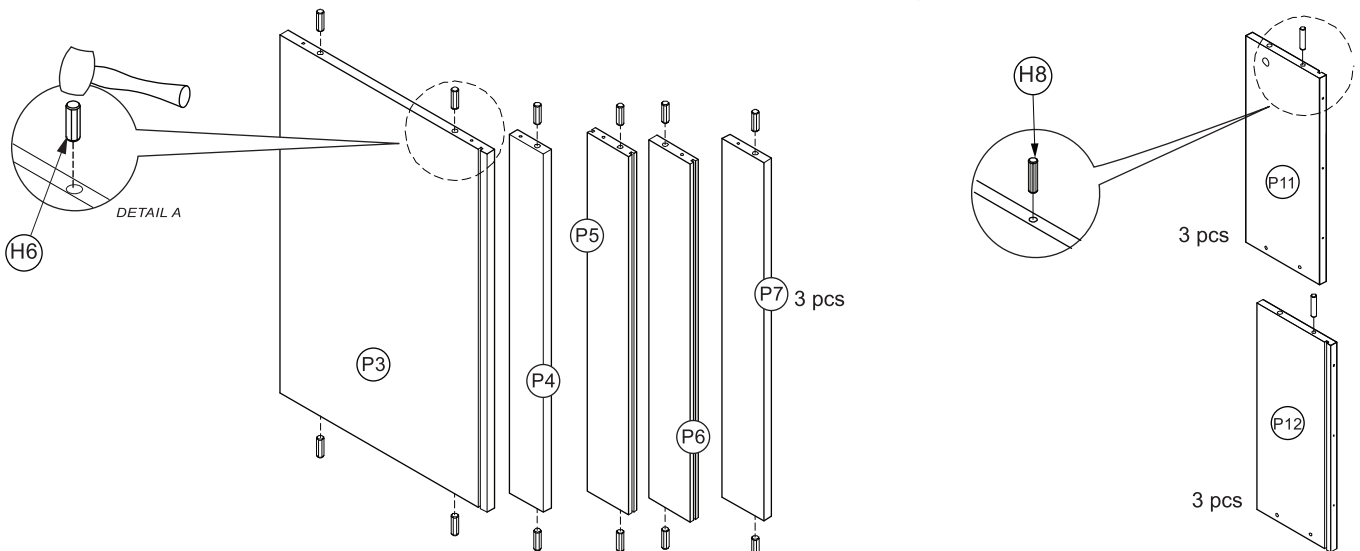

ASSEMBLY INSTRUCTIONS

STEP 2 install the hardware into the following parts respectively.

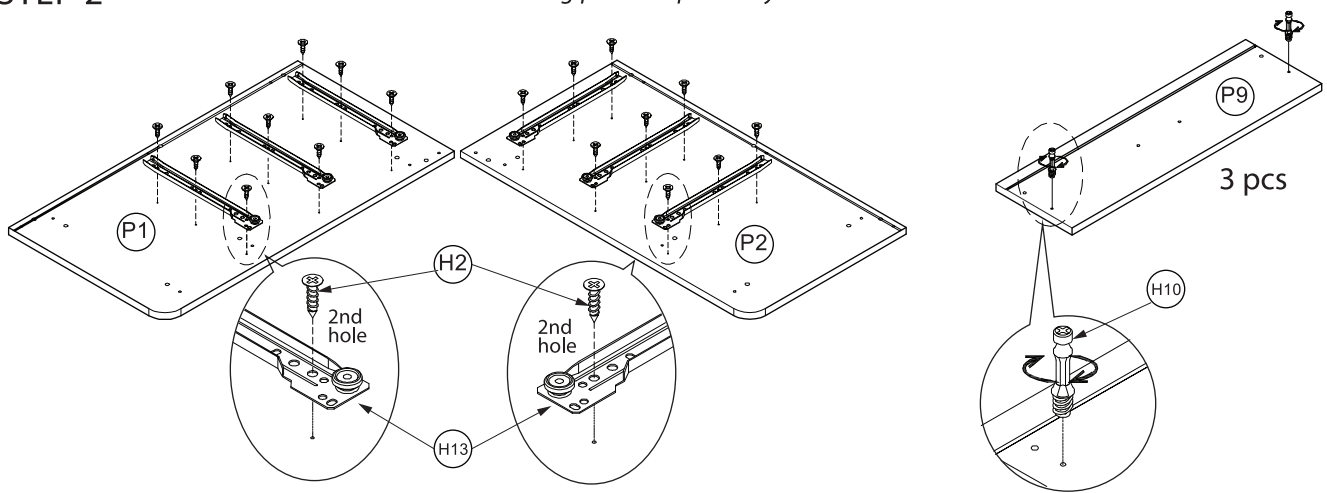

STEP 3

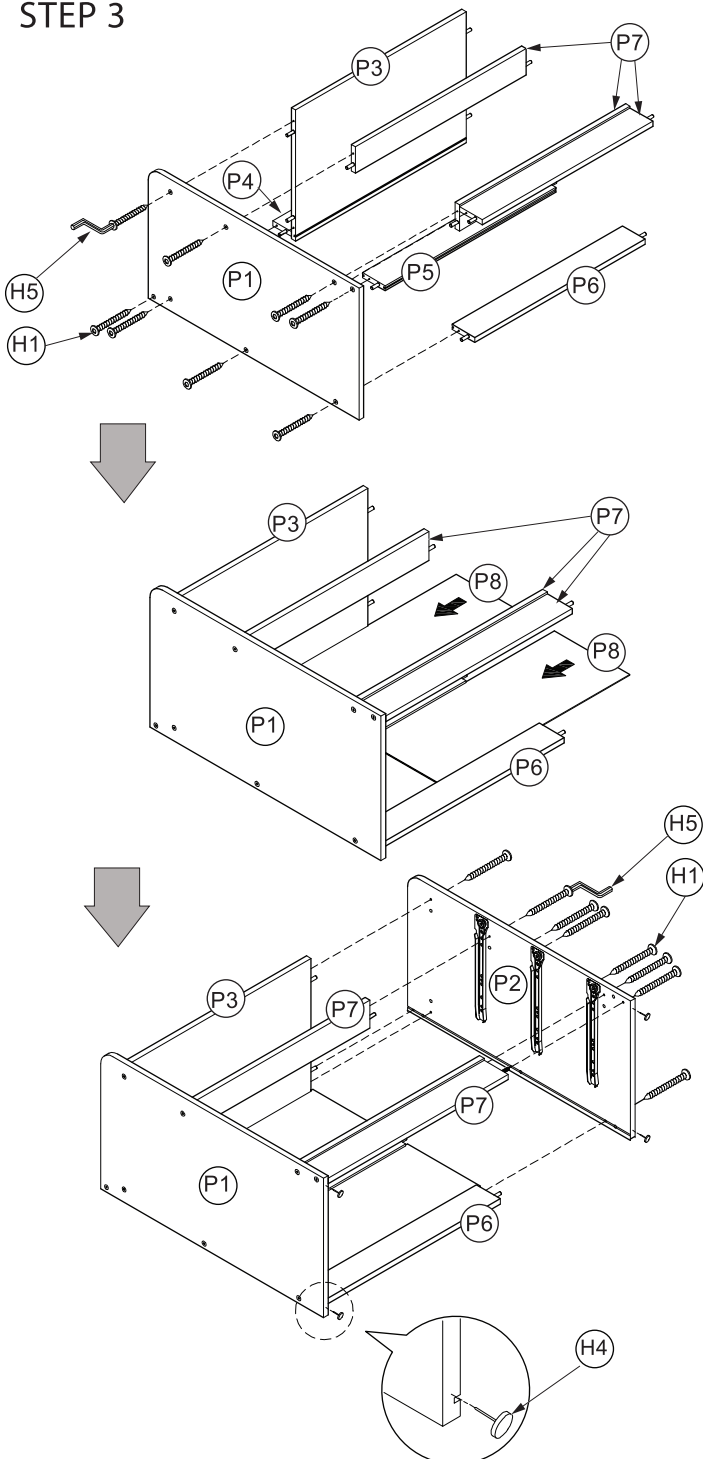

STEP 4 Drawer assembly.

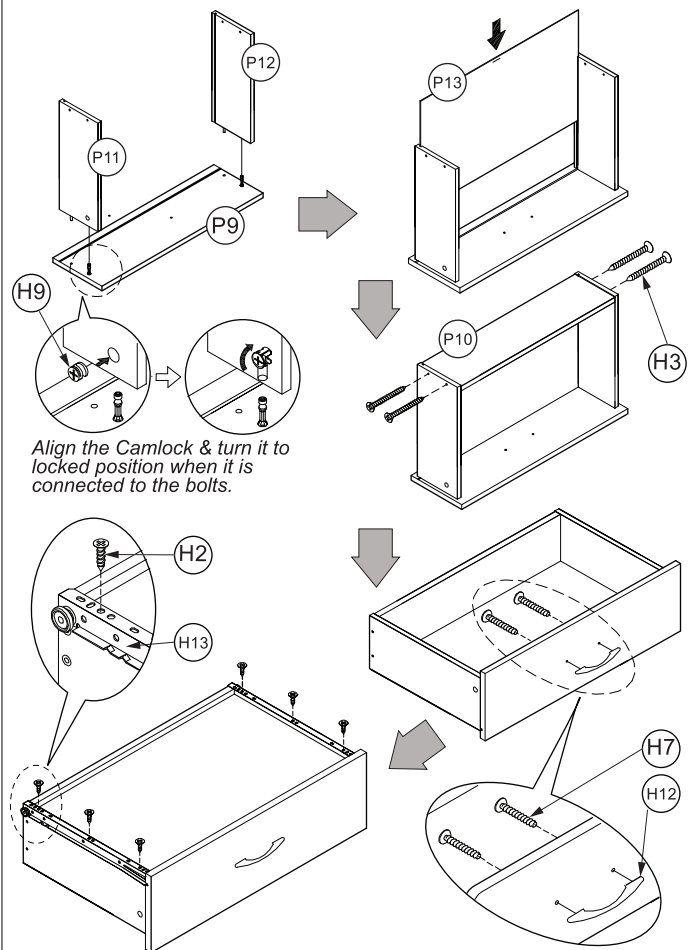

STEP 5

