

BAYTINA SMART TOILET

INSTRUCTIONS FOR USE AND INSTALLATION



Foshan Beitina Technology Co.,LTD.

ADD: No. 7, Floor 1, Building 18,
Casa Ceramics and Sanitary wares Mall,
Jihua 4th Road, Chancheng District, Foshan City,
Guangdong Province, China

Made in china

Baytinabathroom@gmail.com

The company reserves the right to interpret this instruction manual. If there are changes to products and technical parameters without further notice, please refer to the latest version of the instruction manual.

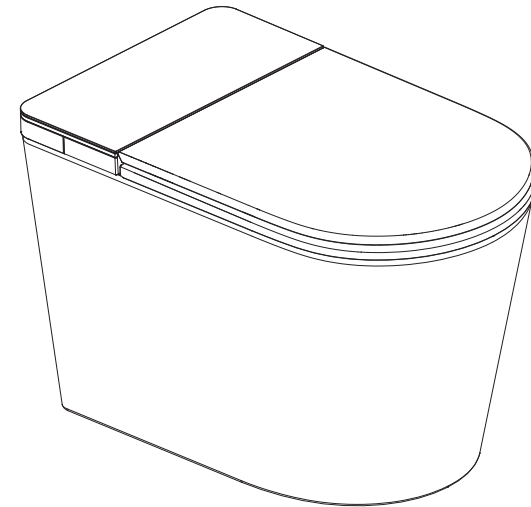

Model: TINA-01 MAX

PRE-READING INSTRUCTIONS

1. Please read this manual carefully before installation and use;
2. The appearance of the product is subject to the actual.
3. For product functions, please refer to the configuration of the model actually purchased.
4. Please keep the instruction manual properly and take it out to read when necessary.

1 - Configuration functions sheet2
2 - Accessories List 4
3 - Tools Preparation 4
4 - Product Introduction 5
5 - Safety Precautions 6
6 - Precautions before Installation 9
7 - Installation Steps 11
8 - Remote Control Operating Instructions 15
9 - Other Functions Description 18
10 - Button Operation Instructions 19
11 - Function Settings 20
12 - Troubleshooting 21
13 - Maintenance 22
14 - Product Specifications 23
14 - Water Efficiency And Energy Efficiency 24
15 - Instructions On Environmental Protection 25
16 - Limited Warranty 28

Category	Functions	Model	TINA-01 MAX
Power	Voltage 110V		●
Flush	Dual pump zero water pressure		●
	Flush by Foot Sensor		●
	Flushing After Leaving seat		●
	No-power Flush		●
Wash mode	Rear/Front wash		●
	Massage wash		●
	Wand Position Adjustment		●
	Water Pressure Adjustment		●
	Washing Water Temp Adjustment		●
Heated Seat	Seat temp adjustment		●
	Antibacteria seat		●
Dryer	Air temp adjustment		●
	Drying Air strength		●
Lid-Seat Operation	Microwave sensor		●
	Auto Lid/Seat function		●
Comfort Functions	Deodorization		●
	Wet The Toilet Bowl After Seated		●
	Auto wash Mode		●
	User memory		●

Note: "●" represents that the product has this function;
 "—" represents that the product does not have this function.

1 - CONFIGURATION FUNCTIONS SHEET BAYTINA

Category	Functions	Model	TINA-01 MAX
Comfort Functions	Auto Temp Mode		●
	Self-cleaning		●
	Night light		●
	LED Display		●
	Nozzle Disinfection		●
UI Control	Button control		●
	Remote control		●
Accessories	Ambient light		●
	Angle valve filtration		●
	Externsl filtration		●

Note: "●" represents that the product has this function;
 "—" represents that the product does not have this function.

2 - ACCESSORIES LIST BAYTINA

Flange Ring

User Manual

Gloves

Remote Control

Expansion screws for remote control

Screw nut
 NPT5/8" NPT9/16" NPT3/8"

Copper sleeve NPT1/2"

Inlet Valve
 G3/4"

Backup Battery Pack for Power Outage
 12V Batteries not included

3 - TOOLS PREPARATION

Impact drill

Caulking gun

Seal Tape

Cutter

Marker pen

Screwdriver

Band tape

Measuring cup

Wrench

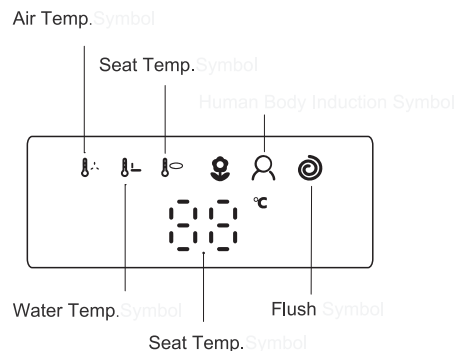
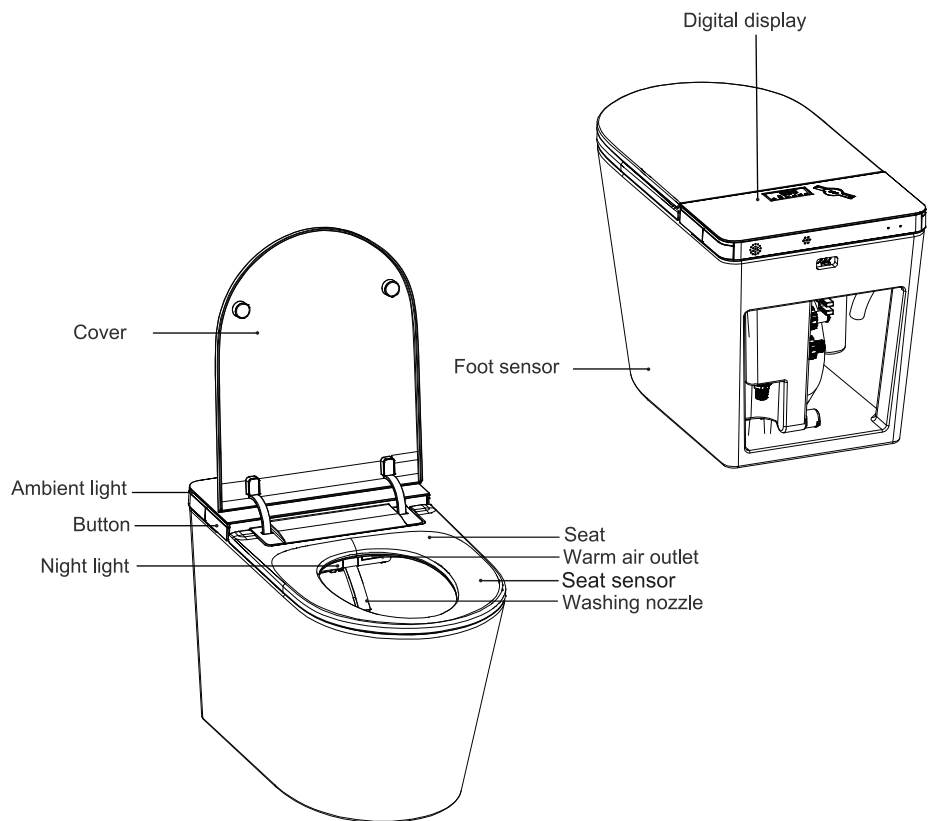

- Error Code Indication**
- E1 Seat temperature sensor error
 - E2 Seat over temperature error
 - E3 Air temperature sensor failure error
 - E4 Water temperature sensor error
 - E5 No water flow error
 - E6 Water over temperature
 - E7 Communication error between main board and sub board

Note: Above parts are just one of the appearance for smart toilet. Different models may have slightly different appearance and functions. Please refer to the actual product.

Be sure to carefully read this "Safety Precautions" document before beginning installation.

Please comply with all safety warnings and precautions.

Warning This symbol indicates misuse may result in death or serious injury.





Caution This symbol indicates misuse may result in injury or physical damage.







Warning

- Do not use this product with any power supply other than the onespecified. Doing so may result in heat or fire.
- When installing this product, comply with the regional codes andstandards on installation work. All-pole disconnection incorporated in thefixed wiring shall be provided.
- Do not turn on the electricity and water supply for the product untilinstallation work is complete.
- Before installing this product, keep the main inlet valve closed to avoidproperty damage caused by water leakage.
- If the new toilet is not installed immediately, temporarily place a rag inthe floor to avoid the risk of hazardous gases.

CAUTION

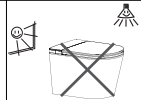

- Comply with all local plumbing and electrical codes . Power and water pipesshould be wall mounted.
- The length of power cord is approximately 15 meters. install the power socketwithin the reach area of power cord . Socket should be higher than floor where itwill not be easily wet by water.
- Inspect the smart toilet carefully to check is there any damage.
- In winter, when the product is transported over long distances or stored for a longtime, the remaining water in the product may freeze. in order to prevent damagecaused by freezing, the product must be placed in a warm room for 30 minutes toallow it to defrost naturally before installation as well as water and electricityconnection.

 Warning	
 Must be obeyed	<ul style="list-style-type: none"> ● Refrain from sitting on the seat for long periods. it may cause low-temperature burns. To prevent the following persons from getting a moderate temperature burn during use, other person should turn off the toilet seat heater. <ol style="list-style-type: none"> ① Young children, the aged and other users unable to set the temperature appropriately themselves. ② The ill, physically disabled and others who do not have freedom of movement. ③ Those using any medicines that cause drowsiness (sleeping or cold medicine),- those who have been drinking heavily, anyone severely fatigued and anyone else liable to fall asleep. ● Make sure the power plug is fully plugged into the outlet. If not fully inserted, it may cause electric shock or fire. Do not connect the power supply when cleaning
	<ul style="list-style-type: none"> ● Do not use the product if a malfunction occurs. in case of breakdown or other problem, be sure to cut off power by means such as unplugging the power plug.  ● Do not continue to use the product if it malfunctions In the following situations, please unplug the power plug and close the water inlet valve. ● Do not do anything that may damage the power cord, power plug. Using a damaged power cord may result in a fire, electrical shock, heat or short. <ol style="list-style-type: none"> ① Do not strike, yank, twist, excessively bend, damage, alter, or heat the power cords. ② Also, do not place anything heavy on, bind or pinch the power cords. ● Do not use other water than allowed by the laws and ordinances of the region of use. Only Use drinking water. Do not use seawater or recycled water. Doing so may cause irritation to the skin and malfunction. ● Patients with pacemakers should not use this product. Otherwise, electromagnetic interference will be generated, which may damage the function of the pacemaker and cause life-threatening consequences. ● Keep cigarettes and other open flames away from the product. Otherwise it may cause fire accidents.   ● The appliance is not to be used by persons (including children) with reduced physical, sensory or mental capabilities, or lack of experience and knowledge, unless they have been given supervision or instruction. Do not apply strong force, mechanical shock, step on or stand on the toilet seat, toilet lid or main unit. Doing so may damage the product and cause injury or water damage.

 Notice	
 Forbidden	<ul style="list-style-type: none"> ● Do not lean against the toilet lid.  ● Do not expose to direct sunlight. (Doing so may cause changes in color, irregular heated seat temperature, remote control malfunction or the product malfunction due to the change in temperature.)  ● Please do not impact the ceramic bowl to prevent damage and leakage. ● Do not fold or crush the water supply hose; do not damage by cutting with a sharp object. Doing so may cause water leaks. ● Do not flush anything other than bodily waste and toilet paper. Also, do not flush too much toilet paper. Doing so may clog the toilet, causing waste water overflow and water damage. ● Do not close the lid and toilet seat violently. Doing so may damage the product.
	<ul style="list-style-type: none"> ● To prevent a sudden water leak, do not remove the water filter drain valve when the shutoff valve is open. When installing the water filter drain valve, make sure that it is securely tightened in its proper position. Failure to securely tighten it may cause a water leak. ● Never operate this product if it has a damaged cord or plug, is not working properly, has been dropped or damaged, or has been dropped in water. ● When the ambient temperature is likely to drop to 32 °F (0 °C) or lower regulate the room temperature to prevent damage to the pipes and hoses. ● Do not wipe the product body with dry cloth or toilet paper otherwise it may cause scratches on the product. ● Do not use it when water and electricity are not connected, otherwise the product won't function properly and usage will be affected. ● Do not lift up this product by the toilet seat or lid.
	<ul style="list-style-type: none"> ● Do not pour urine on the toilet body and nozzle, otherwise it may cause malfunction or cause pink or brown stains.  ● Do not touch the power plug during thunderstorms. Doing so may cause electrical shock.  ● When traveling or not using the product over an extended period of time, drain the water out of the main unit and the water supply hose after closing the water shutoff valve, and pull the power plug from the outlet. 

6 - INSTALLATION PRECAUTIONS

BAYTINA

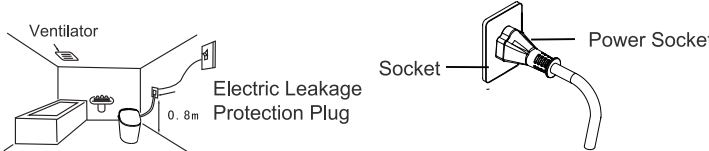
	<ul style="list-style-type: none"> ● Never disassemble, repair or alter, Doing so may cause fire, electrical shock, overheating, short circuit or breakdown.
	<ul style="list-style-type: none"> ● Do not pour water on the product and plug, otherwise it may cause fire or electric shock.
	<ul style="list-style-type: none"> ● This is an electrical product. Do not install it anywhere water is likely to get on the product or anywhere with humidity high enough that water is likely to form on the surface of this product. When using the product in a bathroom, install a fan or ventilation port and ensure good air flow through the bathroom. ● Please set the power socket as follows. Failure to follow these requirements may cause fire or electric shock. <ol style="list-style-type: none"> ① The rated power of the socket must be higher than 2KW; ② The socket should be installed at a place higher than 0.8m from the ground, as far away from the bathtub or shower as possible. <div data-bbox="291 694 1002 845">  </div> <ul style="list-style-type: none"> ● Do not use loose or faulty sockets, as this may cause fire or electric shock.

Water Supply Conditions

For Model with Tank

1. The water pressure for flushing should be $>0.03\text{MPa}$ (3kaf cm^2).
2. The water pressure for cleaning should be $>0.075\text{MPa}$ (0.75kgf/cm^2) and the flow rate should be $>1\text{L/min}$.

If above conditions are not met, the corresponding functions can't be achieved normally; when other products such as faucets are used at the same time, the conditions must also be met.

6 - INSTALLATION PRECAUTIONS

BAYTINA

PRODUCT DIMENSION

Unit: mm

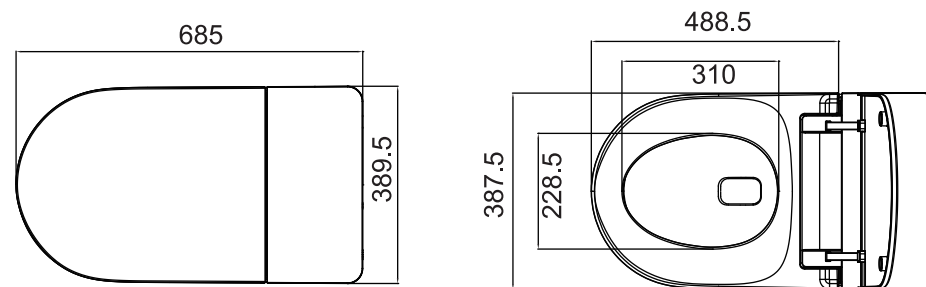
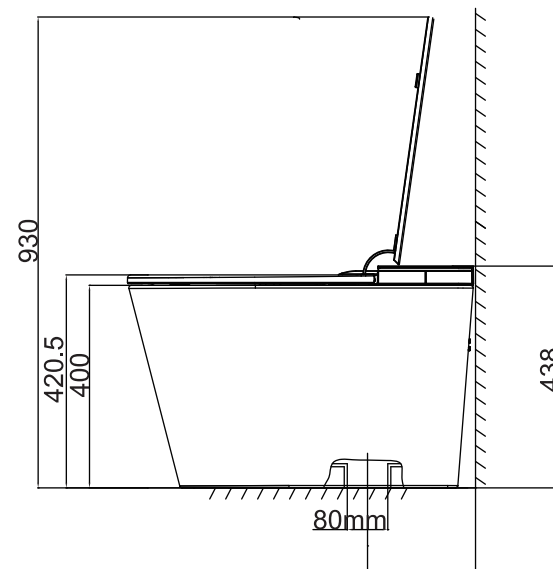

7 - INSTALLATION STEP

BAYTINA

Install the matching two-way angle valve

Mark the center line of the sewage outlet on the ground, and install a three-way angle valve at a suitable position on the wall according to the size of the toilet.

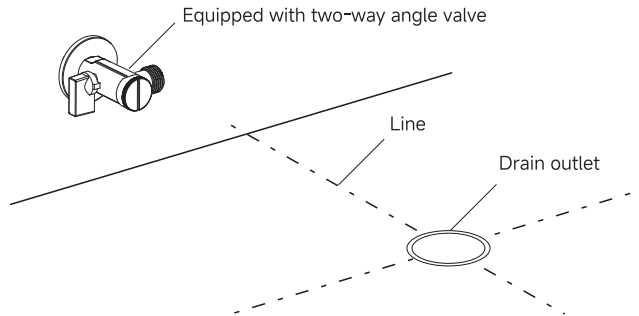

Note:

1. Please use the supplied angle valve when installing this toilet. Use of another angle valve not including a filter may result in blockages in the toilet and bidet waterways.
2. If replacing an existing angle valve, please contact a professional for installation.

Installation Method 1:

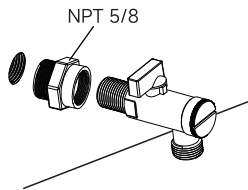

Installation Method 2:

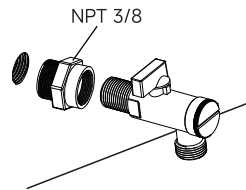

Installation Method 3:

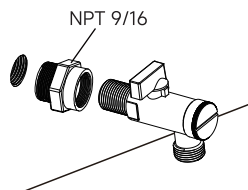

Installation Method 4:

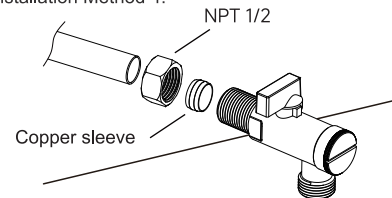

7 - INSTALLATION STEP

BAYTINA

How to use the backup battery to flush during a power outage

1. Find the backup battery pack in the installation box.
2. Retrieve the battery connection wire from behind the toilet.
3. Connect the ends of both wires together.
4. Place the connected battery pack and wires back behind the toilet to complete the battery connection installation.

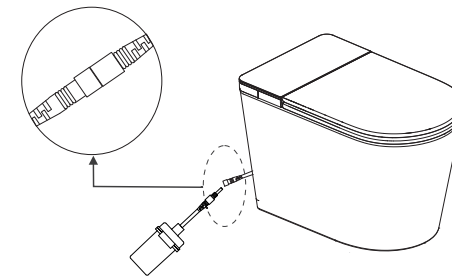

Remote Control Installation

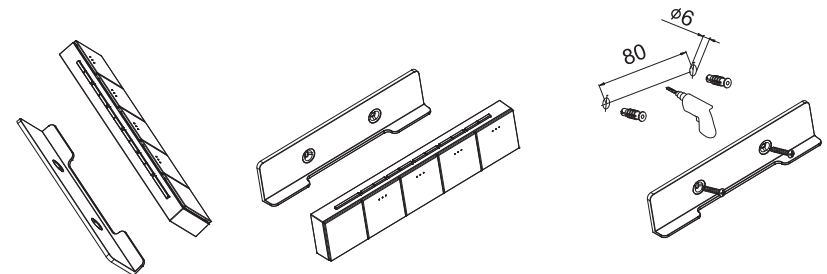

Method 1

(Apply for smooth tiles, glass and smooth wall)

1. Choose proper installation location (Not easy to get wet, easy to takeout or operate);
2. Clean the dust, oil stains, water droplets etc. on the installation wall;
3. Peel off the adhesive tape on the back of the remote control bracket, align the position, and press evenly for 1-2 minutes to make it stick tightly; Placing the remote control after 12 hours;

Method 2

1. Choose proper installation location (Not easy to get wet, easy to takeout or operate);
2. Fix the bracket on the wall by installation accessories pack;
3. Place the remote control on the bracket.

A. Install smart toilet

1. Rough-in template installation

- Align cardboard with the centerline of drain outlet.
- Draw contour line according to cardboard.

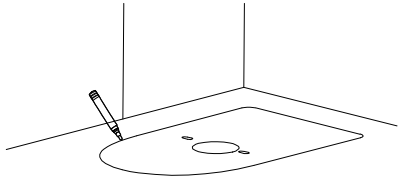

2. Mounting bracket installation

- Assemble the mounting bracket with bolts and then install them to the pre-installed flange plate on the ground and lock tight with nuts.

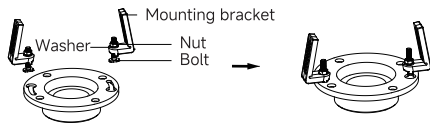

3. Ceramic toilet installation

- Install a sealing flange into drain outlet.
- Install ceramic toilet on the corresponding position.

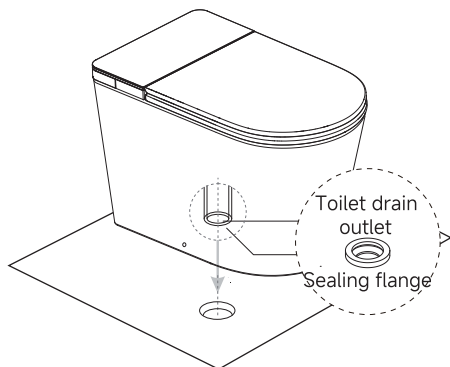

4. Screw installation

- Put the screw through the fixing sleeve and then install it through the holes (on both sides of the toilet bowl) to the mounting bracket on the ground. Lock tight.
- Install the decorative cap on the fixing sleeve.

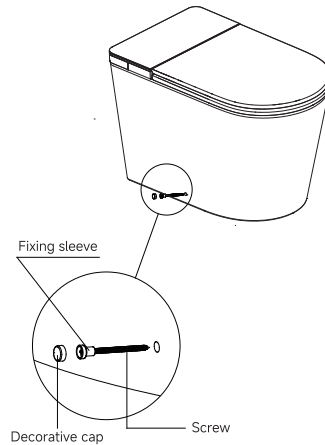

5. Connect the hoses

- Connect the water supply hose of the toilet tank and the water inlet hose of the toilet seat to the three-way angle valve as shown in the

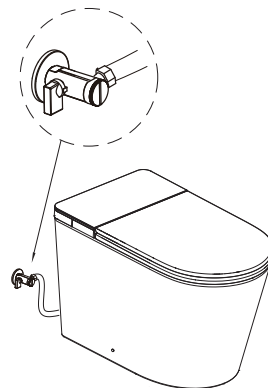

B. Check the inlet valve

1. Turn on the inlet valve to the maximum as shown in the figure.
2. Confirm that there is no water leakage at each connection. If there is any water leakage, please re-tighten the valve or install it again.

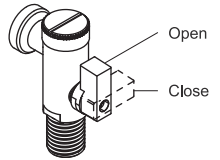

C. Connect the power supply

1. Connect the smart toilet to an AC120 volt power supply.
2. The smart toilet will start self-check after powering on, and the self-check ends with a long beep.

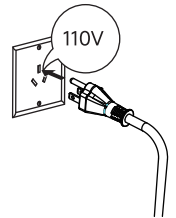

D. Check the toilet flushing

1. Press the flush button to start flushing.
2. At the first flush, the siphon cannot be fully formed due to the lack of water in the main pipe, so it is necessary to flush several times at the first use.

※ If flushing is weak or there is no siphon, please check whether the inlet hose is blocked.

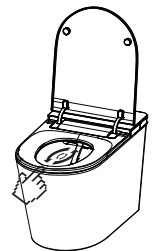

E. Check whether there is water leakage

Check there is no water leakage between the toilet and the floor.

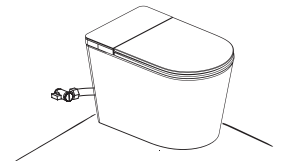

F. Functions test

1. Please refer to the actual configurations and functions of the product.
2. Press function buttons on the toilet and remote to check whether the product functions are normal.





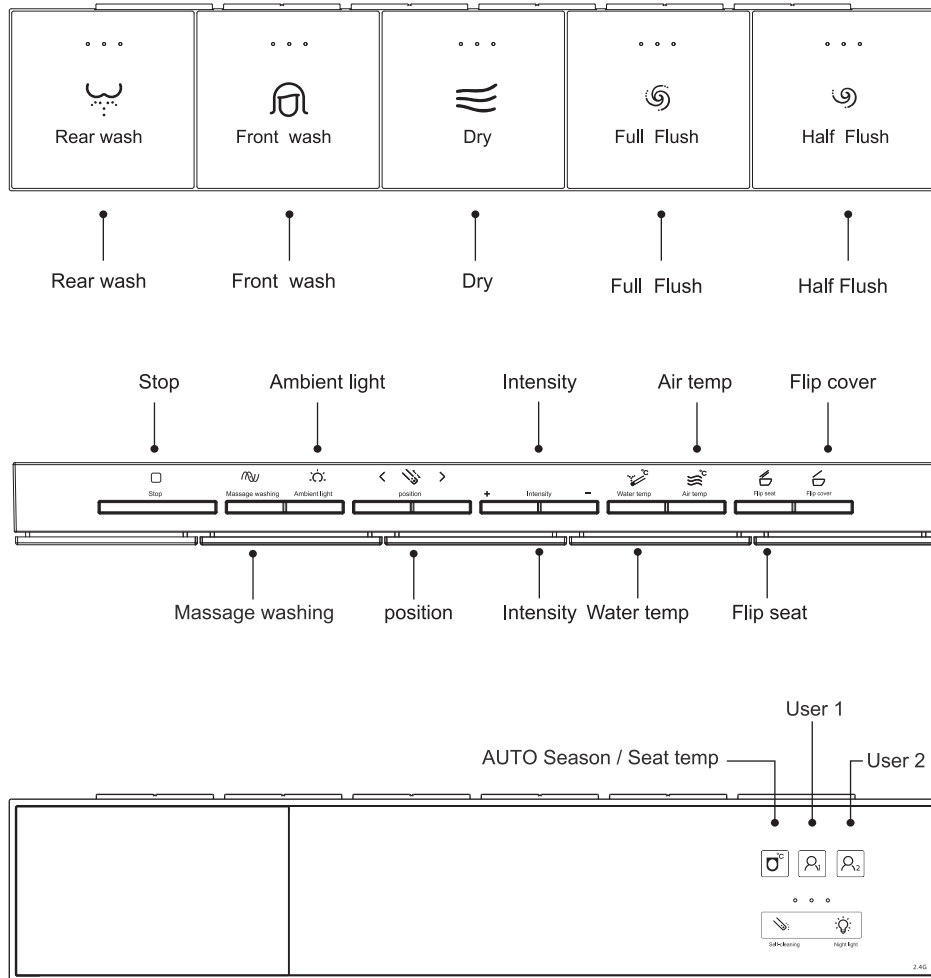

8 - REMOTE CONTROL OPERATING

BAYTINA



Remote control code matching: After the toilet is powered off for 10 seconds, long press the "Front wash" and "Stop" buttons at the same time until the indicator light flashes. Then power on within 10 seconds, the remote control indicator light stops flashing, and the toilet beeps, indicating that the code is successfully matched.





	<p>Rear Washing With Automatic:</p> <ol style="list-style-type: none"> 1-Please seat before starting washing. 2-Short press "Rear Wash" button to start the buttock washing function. 3-Short press again to turn on/off the reciprocating movement of the boom.
	<p>Front Washing With Automatic:</p> <ol style="list-style-type: none"> 1-Please seat before starting washing. 2-Short press "Front Wash" button to start the buttock washing function. 3-Short press again to turn on/off the reciprocating movement of the boom.
	<p>Warm air drying/Air strength adjustment/Five air speeds: While seated, short press the "Drying" button to start the drying function.</p>
	<p>Full Flush:Short press the "Full Flush " button to start the full flushing function.</p>
	<p>Half Flush:Short press the "Full Flush " button to start the full flushing function.</p>
	<p>Stop:Short press the "Stop" button to stop the current function (Except open the cover/seat and flushing).</p>
	<p>Massage washing: During washing mode, short press "Massage washing" button to switch on/off massage washing.</p>
	<p>Short press the "Ambient Light" button to switch on/off the ambient light mode. Long press the "Ambient Light" button to enable/disable the automatic ambient light mode.</p>
	<p>Washing position adjustment: During washing mode, short press the "<" key, to move backward; short press the ">" key, to moves forward. (There are 5 positions for adjustment).</p>
	<p>Washing intensity adjustment: During washing mode, short press the "+" key to increase the washing intensity; short press the "-" key to decrease the washing intensity. (There are 3 positions for adjustment).</p>
	<p>Washing intensity adjustment: During washing mode, short press the "+" key to increase the washing intensity; short press the "-" key to decrease the washing intensity. (There are 3 positions for adjustment).</p>
	<p>Air temperature adjustment: During drying or Manual-temperature mode, Short press the "Air temp" button to select the temperature level from OFF / Low / Mid / High level,which is indicated by the number of beeps of buzzer: OFF-One beep,Low-Tow beeps,Mid-Three beeps,High-Four beeps.</p>

	While not seated, press the "Flip cover" button to open/close the seat.
	While not seated, press the "Flip cover" button to open/close the cover.
	Self-cleaning: Short press "Self-Clean" to start automatic cleaning of the wand and nozzle. (Short press again to turn on/off the reciprocating movement of the boom)
	Night light: Short press the "Night Light" button to turn on/off the night light.
	<p>Seat temperature adjustment: While seated or Manual-temperature mode, Short press the "Seat temperature" button to select the temperature level from OFF / Low / Mid / High level,,which is indicated by the number of beeps of buzzer: OFF-One beep,Low-Tow beeps,Mid-Three beeps,High-Four beeps.</p> <p>AUTO Season:Long press the "Seat temperature" button to turn on/off the Auto-temperature. Auto-temperature: Water temperature, air temperature, and seat temperature are automatically adjusted according to the ambient temperature.</p>
 	<p>User Memory:</p> <p>1-Long press the "User 1"/"User 2' button to memorize the current water temperature, air temperature, seat temperature, etc.</p> <p>2- Short press the "User 1"/"User 2' button , to use the memorized setting.</p>

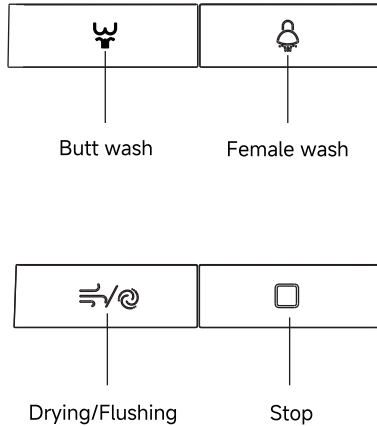
9 - OTHER FUNCTIONS DESCRIPTION		BAYTINA
OTHER FUNCTIONS DESCRIPTION		
Foot touching button	If not seated, short touch the foot switch (Only for manual model) : a) Open the cover →, open the seat (less than 6 seconds) ← close the seat. b) Open the cover →, open the seat (more than 6 seconds)← close the seat and flushing.	
Wet The Toilet Bowl After Seated	After 30s since left the seat, once seated again, the upper water nozzle flushes automatically to pre -wet the inner surface of the toilet bowl (the function is active as default),and can be switched.	
Flushing After Leaving seat	If the seating time is more than 6 seconds and there is no flushing before leaving the seat, if automatic flushes after leaving seat. (This function is active by default).	
Automatic Deodorization Function	Once human seated, it automatically starts the chemical catalyst deodorization device. (This function is active by default)	
Automatic Open Cover	When human body is close to the toilet , it opens the cover automatically. When there is no operation or no human body approaching, it close the cover for about 2 minutes (if the seat is opened more than 6 seconds and no flushing during this period,it closes the cover and flush) (Only limited to this configuration model)	
No-power Flush	In the state of power outage, shore press the knob to start the flushing function.	
Nozzle Disinfection	When washing stops,wand move back and nozzle disinfection starts for about 1 munute with UV light illuminated.	

10 - BUTTON OPERATION INSTRUCTIONS BAYTINA



BUTTON OPERATION INSTRUCTIONS	
FUNCTION	FUNCTION DESCRIPTION
	Short press to start front washing . During front washing , short press again to start massage washing. During massage washing, short press again to stop the massage washing.
	Short press to start rear washing. During rear washing ,short press again to start massage washing. During massage washing, short press again to stop the massage washing.
	Short press to start flushing, Long press to start drying.
	Short press to stop function; Long press for 10 seconds to enter the menu (hidden functions setting)

11 - FUNCTION SETTINGS BAYTINA

HIDDEN FUNCTIONS	
Function Settings	How to set functions: Press and hold the knob for about 5 seconds to enter the setting mode with the number on the display flashing. This number has two digits: the first one is "function digit" and the second one is "status digit". Short press the knob to select the required function and turn the knob to do the setting.
	Microwave Sensor Function digit:5 status digit: 0-Disabled 1-Enabled
	Microwave Sensing Function digit:6 status digit: 1/2/3/4/5 1-Shortest Distance 5-Longest Distance
	Seat opening force adjustment Function digit:8 status digit: 1/2/3/4/5 1-weakest force 5-strongest force
Lid opening force adjustment Function digit:9 status digit: 1/2/3/4/5 1-weakest force 5-strongest force	

Please refer to the table below for the solutions of problems which might occur in using this product. If the problem still exists after trying the solutions below, please contact our customer service center for further help.

Problems	Possible Causes	Solutions
Product doesn't power on	Loose connection of power socket.	Check power socket.
	Leakage Protection Plug Problem.	Press the reset button on the leakage protection plug to reset power. If the red led can stay illumination, this means that this plug functions properly. If this plug keeps trip-off, please unplug this plug from the socket, and contact our customer service for help.
	Product has been turned off.	Please try long-press of "Stop" button on remote control to turn on the product.
Washing function doesn't work properly.	Seat sensor can't detect people seating.	Please adjust the seating position.
	Water mains failure.	Please wait until water mains restored.
	Water inlet valve on the wall is turned off.	Turn on the valve.
	Filter is blocked.	Please clean the filter or replace it.
Washing pressure is low.	Water supply pipe is trapped.	Reconnect the pipe.
	Filter is partially blocked.	Please clean the filter or replace it.
Washing suddenly stops.	Washing pressure is set to a low level.	Please increase the washing pressure from remote control.
	Washing period has timed out.	Restart the washing function.
Drying suddenly stops.	Seat sensor can't detect people seating.	Please adjust the seating position, and restart the washing function.
	Drying temperature is set to a low level.	Increase the drying temperature level from remote control.
Drying suddenly stops.	Seat sensor can't detect people seating.	Please adjust the seating position, and restart the drying function.
	Drying period has timed out.	Restart the drying function.
Seat Temperature is low.	Seat temperature is set to a low level.	Increase the Seat temperature level from remote control.
	Product is just being turned on.	Please give some time for temperature rise.
	Ambient temperature is too high when Auto-Temp mode is enabled.	Disable Auto-Temp mode and re-adjust temperature level.

Problems	Possible Causes	Solutions
Remote control doesn't work.	Battery is low.	Change batteries.
	Batteries are installed wrongly.	Reinstall the batteries according to the mark.
Flush is not working properly.	Filter is blocked.	Clean the filter.
	Water supply pipe problem.	Check the water supply pipe.
	The gap time between two flushes is less than 30 seconds.	make sure of more than 30 seconds gap time between two consecutive flushes.
	Drain is blocked.	Unblock the drain.

13 - MAINTENANCE

BAYTINA

In order to ensure the normal use of the product, please clean and maintain the product regularly. Note that when performing cleaning and maintenance, be sure to unplug the power plug from the socket, close the water supply valve and stop the water supply.

Cleaning and maintenance methods for covers, seats and other plastic parts.

Please use a soft damp cloth to wipe the will become difficult to clean. Please wipe it with water frequently. In addition, wiping with water can prevent the generation of static electricity, which can absorb dust and cause the product to become black and dirty.



Cleaning and maintenance methods for ceramic area

Please wipe the ceramic area of the product with a soft damp cloth. Soft brush, or sponge to clean it with a neutral detergent and cold or warm water. Do not use inappropriate cleaning agents, such as: toilet cleaners, bleach, alcohol, deodorizing powder, gasoline etc.

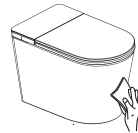

Valve filter maintenance

1. Turn the switch clockwise to the off position;
2. Use a flat-blade screwdriver or a coin to counterclockwise unscrew the filter net .
3. Use a brush to clean the dirt and impurities on the filter.
4. Clockwise screw the cleaning filter into the three-way valve, and check to ensure that the filter is installed in place.
5. Turn the switch counterclockwise to the fully open position.

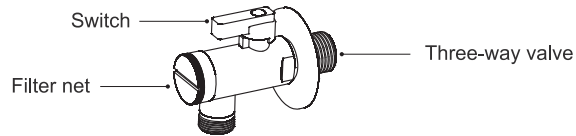

Do not add water or detergent to the of the remote control. Do not get the electrical parts and power plug wet with water or detergent. Otherwise there may be a risk of electric shock and fire.

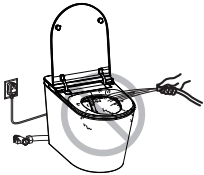

When cleaning and maintaining plastic parts, do not use unsuitable cleaners (toilet cleaner, alcohol, cresol, benzene, detergent powder, bleach, tinas, paint thinner, residential cleaner, gasoline, etc.) otherwise the plastic parts cracking may result in personal injury, electric shock, or fire.



Nozzle cleaning and maintenance methods

When not seated, press the "self-cleaning" self-cleaning . (Short press again to start/stop nozzle moving.) If the nozzle is dirty, clean it with a toothbrush. Do not use too much force when scrubbing the nozzle, otherwise it will damage the washer.

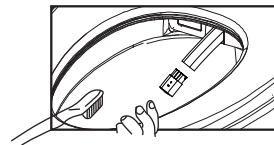

14 - PRODUCT SPECIFICATIONS

BAYTINA

Rated Voltage		RAC110V/60HZ
Rated Power		950W
Max Power		1600W
Ambient Temperature Range		4 C-35 C
Supply Water Temperature Range		3 C-35 C
IP Rating		IPX4
Water Volumn For One Flush		5.0L
Flush	Required Water Supply Pressure	0.08Mpa~0.75Mpa
Wash mode	Required Water Supply Pressure	0.08Mpa~0.75Mpa
	Water Heater	Max heating power of 1600W with over-temperature protection.
	Rear Wash Flow Rate	450m~650ml
	Front Wash Flow Rate	450m~650ml
	Child Wash Mode	All temperatures and washing pressure are set to low levels, Wand position is set to the farrest position.
	Auto Mode	In this mode, it firstly starts washing, and then flush followed by drying.
	Wand Washing Massage	Wand keeps moving forwards and backwards while washing.
	Water Pressure Massage	Keep changing water presure between high and low levels while washing.
	Water Pressure Adjustment	3 pressure levels for adjustment.
	Washing Water Temperature Adjustment	5 position levels for adjustment.
Heated Seat	Heater	Washing water temperature can be set to OFF/Low/Mid/High levels.
	Temperature Settings	Max power of about 50W with over-temperature protection.
Dryer	Heater	Seat temperature can be set to Ambient/Low/Mid/High levels.
	Drying Temperature Adjustment	Max Heater power of 250W with over-temperature protection. Drying temperature can be set to Ambient/Low/Mid/High levels.

14 - PRODUCT SPECIFICATIONS

BAYTINA

Lid-Seat Operation	Auto Version	The opening and closing of the Lid and Seat can be controlled by remote control, microwave sensor or foot sensor.
Comfort Functions	Deodourising	This function starts once seated. It can be enabled or disabled
	Foaming function	this function starts once seated if the auto-foaming mode is enabled. This mode can be enabled or disabled. This function can also be activated by remote control.
	Self-Clean Function	when started, Wand moves out and water flows out to clean the wand and nozzle.
	Night Light	It illuminates to help find the toilet easily. It can be turned on/off.
	LED Display	It can show the temperature information as well as some runing information.
	Wet The Toilet Bowl After Seated	it wets the toilet inside surface with small amount of water once seated. This function can be enabled/disabled.
	Flushing After Leaving seat	it flushes the toilet after leaving seat. This function can be enabled/disabled.
	No-power Flush	when power-cut, it can flush the toilet using the battery pack provided.
	Auto-Temp Mode	When enabled, it sets the temperatures automatically according to the ambient temperature.
UI Control	Remote Control	2.4G Frequency, Powered by 2 AAA batteries.
	Knob Control	Using knob to conrol washing/flushing/drying functions.
	Foot Sensor	For auto version it controls the lid/seat operation. For manual version, it is for flushing the toilet.
Leakage Protection Power Cable		Max load of 10A, Leakage Protection Current of 10mA; Cable length of 1.5m.
Dimensions(LxWxH)		685x390x438 (mm)
Net Weight		about 35KG

15 - WATER EFFICIENCY AND ENERGY EFFICIENCY

BAYTINA

Toilet Energy Efficiency and Water Efficiency levels Instructions.

The energy and water efficiency levels of smart toilets are divided into three levels, the 3rd level is the lowest energy and water efficiency. The unit cycle energy consumption, average washing water consumption and average flushing water consumption of each level should comply with the provisions of Table 1.

Table 1 Smart toilet energy efficiency and water efficiency level indicators

Smart toilet energy efficiency and water efficiency levels			Level 1	Level 2	Level 3
Energy efficiency level index	Energy consumption per cycle/(kw.h)	With seat heating function	≤0.030	≤0.040	≤0.060
		Without seat heating function	≤0.010	≤0.020	≤0.030
Water efficiency level index	Average water consumption for washing/L		≤0.30	≤0.50	≤0.70
	*Average water consumption for flushing/L		Comply with the requirements of level 3 indicators in GB 25502		
	*Full water consumption for dual flushing/L				
Note 1: "*" Applies to 70% of all-in-one smart toilets.					
Note 2: For each water efficiency level, the average half-flush water consumption of a dual-flush toilet shall not be more than 70% of the maximum water consumption limit for full flushing.					

The energy efficiency and water efficiency level of this product is Level 2.

The names and contents of hazardous substances in the product.

In accordance with the relevant regulations and requirements of the "Administrative Measures for the Restriction of the Use of Hazardous Substances in Electrical and Electronic Products" of the People's Republic of China, the following format including the names of electronic product parts and hazardous substances is provided.

Part Name	Harmful Substance					
	Pb	Hg	Cd	Cr(VI)	PBB	PBDE
Control device	x	○	○	○	○	○
Remote control	x	○	○	○	○	○
Wires and connectors	○	○	○	○	○	○
Housing components	○	○	○	○	○	○
Thermal device	x	○	○	○	○	○
Drying device	x	○	○	○	○	○
Washing device	x	○	○	○	○	○
Waterway components	x	○	○	○	○	○
Labels	○	○	○	○	○	○

This form is prepared in accordance with the provisions of SJ/T 11364. 0: Indicates that the content of the hazardous substance in all homogeneous materials of this part is below the limit required by the GB/T 26572 standard. X: Indicates that the content of the hazardous substance in at least one homogeneous material of the component exceeds the limit requirements stipulated in the GB/T 26572 standard. The components marked with the above "x" currently have no alternative technologies and components, and they comply with the national "Electrical Appliances" Regulatory requirements of the Measures for the Administration of Restrictions on the Use of Hazardous Substances in Electronic Products.

Under the current technical level, the content of harmful substances used is controlled to the lowest level. The Company will continue its efforts to reduce the use of these substances through improved technologies. The "environmental protection use period" of this product is 10 years. This is shown in the figure on the right. The environmentally friendly use period of replaceable parts may differ from the environmentally friendly use period of the product. Only use this product under normal conditions as described in this manual. The "environmentally friendly use period" is only valid.



Limited Warranty

Three Year Limited Warranty

1. Baytina warrants its product to be free from defects in materials and workmanship during normal use when properly installed and serviced, for a period of three years from date of purchase. This limited warranty is extended only to the ORIGINAL PURCHASER of the product and is not transferable to any third party, including but not limited to any subsequent purchaser or owner of the product. This warranty applies only to Baytina Product is purchased and installed in North, Central and South America.

2. Baytina's obligations under this warranty are limited to repair, replacement or other appropriate adjustment, at Baytina's option, the product or parts found to be defective in normal use, provided that such product was properly installed, used and serviced in accordance with instructions. Baytina reserves the right to make such inspections as may be necessary in order to determine the cause of the defect. Baytina will not charge for labor or parts in connection with warranty repairs or replacements. Baytina is not responsible for the cost of removal, return or reinstallation of the product.

3. This warranty does not apply to the following items:

- Damage or loss sustained in a natural calamity such as fire, earthquake, flood, thunder, electrical storm, etc.
- Damage or loss resulting from any accident, unreasonable use, misuse, abuse, negligence, or improper care, cleaning, or maintenance of the Product.
- Damage or loss resulting from sediments or foreign matter contained in a water system.
- Damage or loss resulting from the quality of water in the region where the product is used.
- Damage or loss resulting from improper installation or from installation of the Product in a harsh or hazardous environment, or improper removal, repair or modification of the Product. This includes locations where the water pressure is above local codes or standards.
- Damage or loss resulting from electrical surges or lightning strikes or other acts which are not the fault of Baytina or which the Product is not specified to tolerate, including failure to use the factory equipped cord and plug or use of a loose or faulty electrical outlet or use of a current or socket other than a 120V, 60Hz electrical current from a GFI (ground, fused) socket.
- Damage or loss resulting from normal and customary wear and tear, such as gloss reduction, scratching or fading over time due to use, cleaning practices or water or atmospheric conditions, including but not limited to, the use of bleach, alkali, acid cleaners, dry (powder) cleaners or any other abrasive cleaners or the use of metal or nylon scrubbers.

4. If the Danger Label which has been placed over the seams on the back of the Product top unit is broken or otherwise not intact, this limited warranty is void.

5. In order for this limited warranty to be valid, proof of purchase is required.

6. If the Product is used commercially or is installed outside of North, Central or South America, Baytina warrants the product to be free from defects in materials and workmanship during normal use for one year from the date of installation of the Product, and all other terms of this warranty shall be applicable except the duration of the warranty.

7. This warranty gives you specific legal rights. You may have other rights which vary from state to state, province to province or country to country.

8. To obtain warranty and replacement parts, please send e-mail to Baytinabathroom@gmail.com. with the original receipt information, Baytina will determine whether to repair or replace your product, issue a refund or issue a credit. **WARNING!** Baytina shall not be responsible or liable for any failure of, or damage to, this Product caused by either chloramines in the treatment of public water supply or cleaners containing chlorine (calcium hypochlorite).

NOTE: The use of a high concentrate chlorine or chlorine related product's can seriously damage the fittings. This damage can cause leakage and serious property damage.

This written warranty is the only warranty made by Baytina. Repair, replacement or other appropriate adjustment as provided under this warranty shall be the exclusive remedy available to the original purchaser. Baytina shall not be responsible for loss of the product or for other incidental, special or consequential damages or expenses incurred by the original purchaser, or for labor or other costs due to installation or removal, or costs of repairs by others, or for any other expense not specifically stated above. In no event will Baytina's responsibility exceed the purchase price of the product. Except to the extent prohibited by applicable law, any implied warranties, including that of merchantability or fitness for use or for a particular purpose, are expressly disclaimed. Some states do not allow limitations on how long an implied warranty lasts, or the exclusion or limitation of incidental or consequential damages, so the above limitation and exclusion may not apply to you.