

# WAIMEA GARDEN BENCH

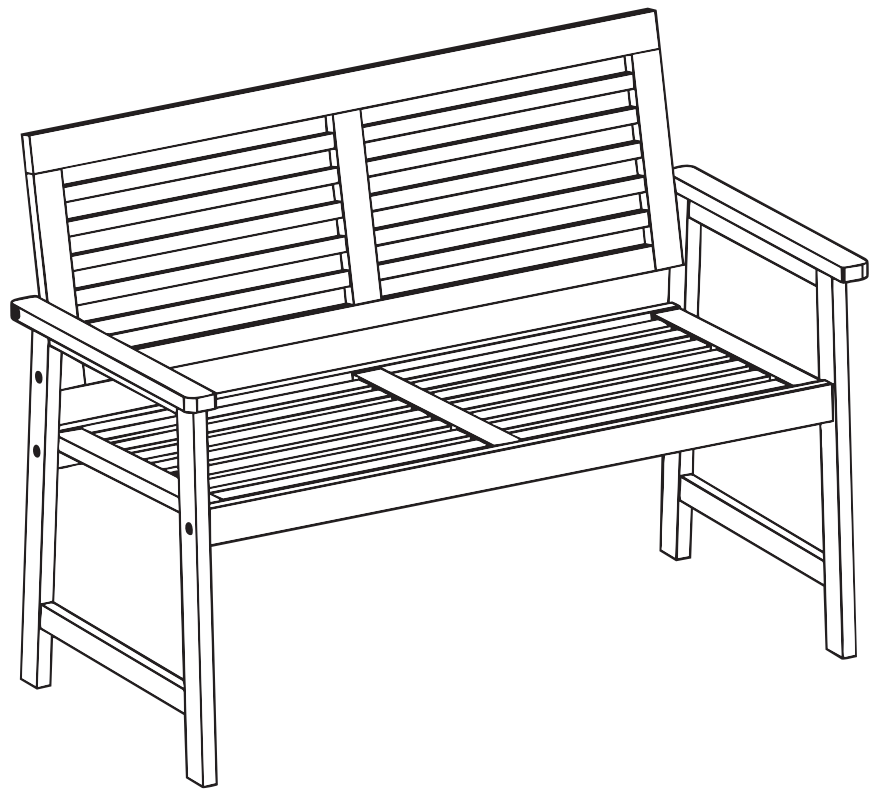



**220kg**  
**MAX CAPACITY**



**ONE**  
**PERSON**



**APPROX. 15**  
**MIN SETUP**

Thank you for choosing us. We design each piece with care and craftsmanship, so you can enjoy your space even more. This booklet will guide you step-by-step through the assembly process.

**Got any questions?** We're always happy to help!

## ! NOTICE

Please retain these instructions for future use.

Care should be taken when assembling the product. If you notice any required parts are missing, please get in touch.

Stop using the product immediately if any parts are broken, damaged or worn. We strongly advise awaiting repairs or factory replacements being installed before use in such cases.

## COMPONENTS

I

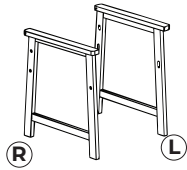

II

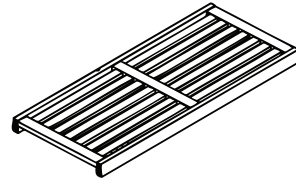

III

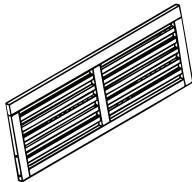

## HARDWARE

A x 8



B x 2

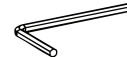

## STEP 1

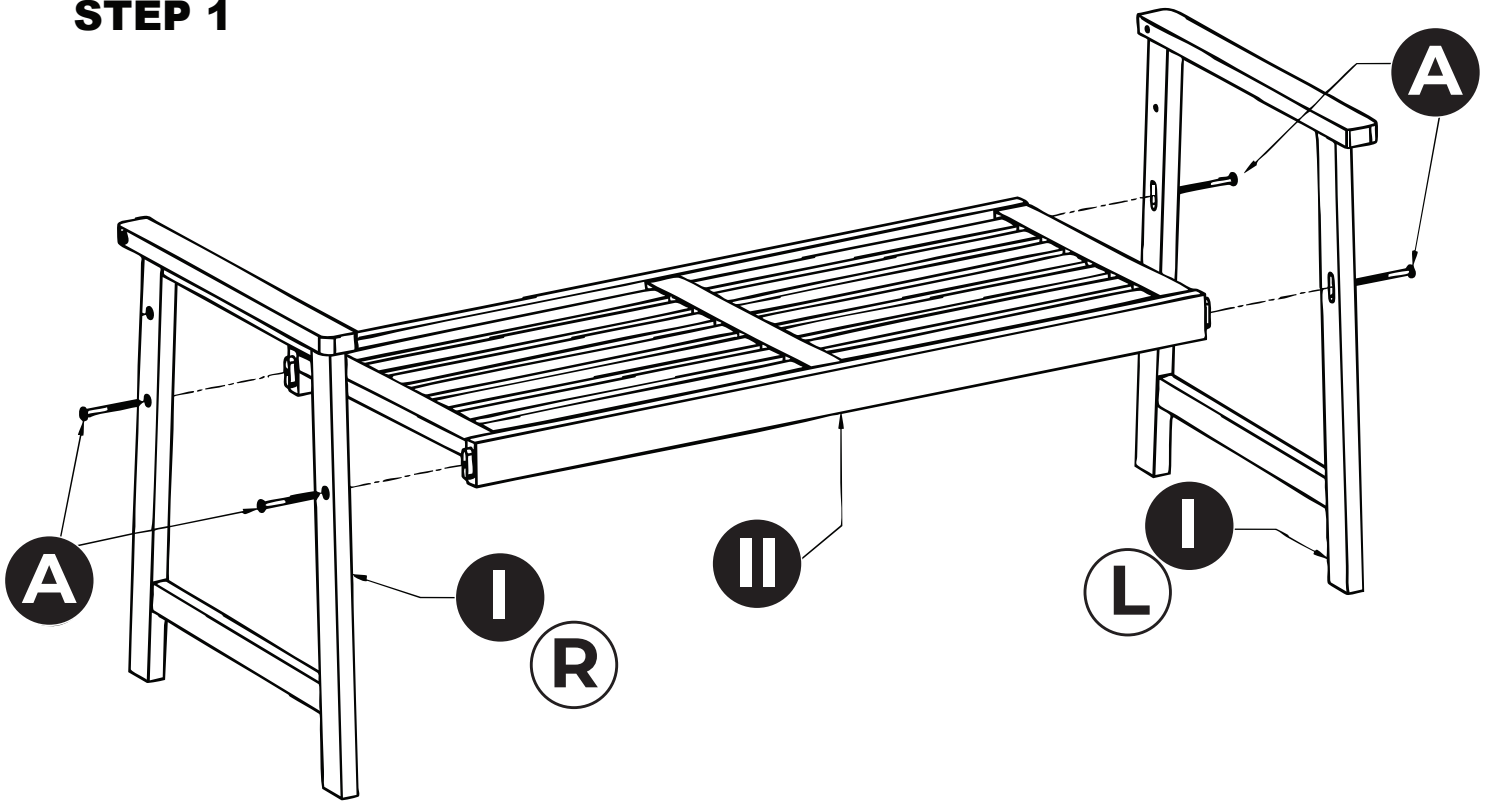

## STEP 2

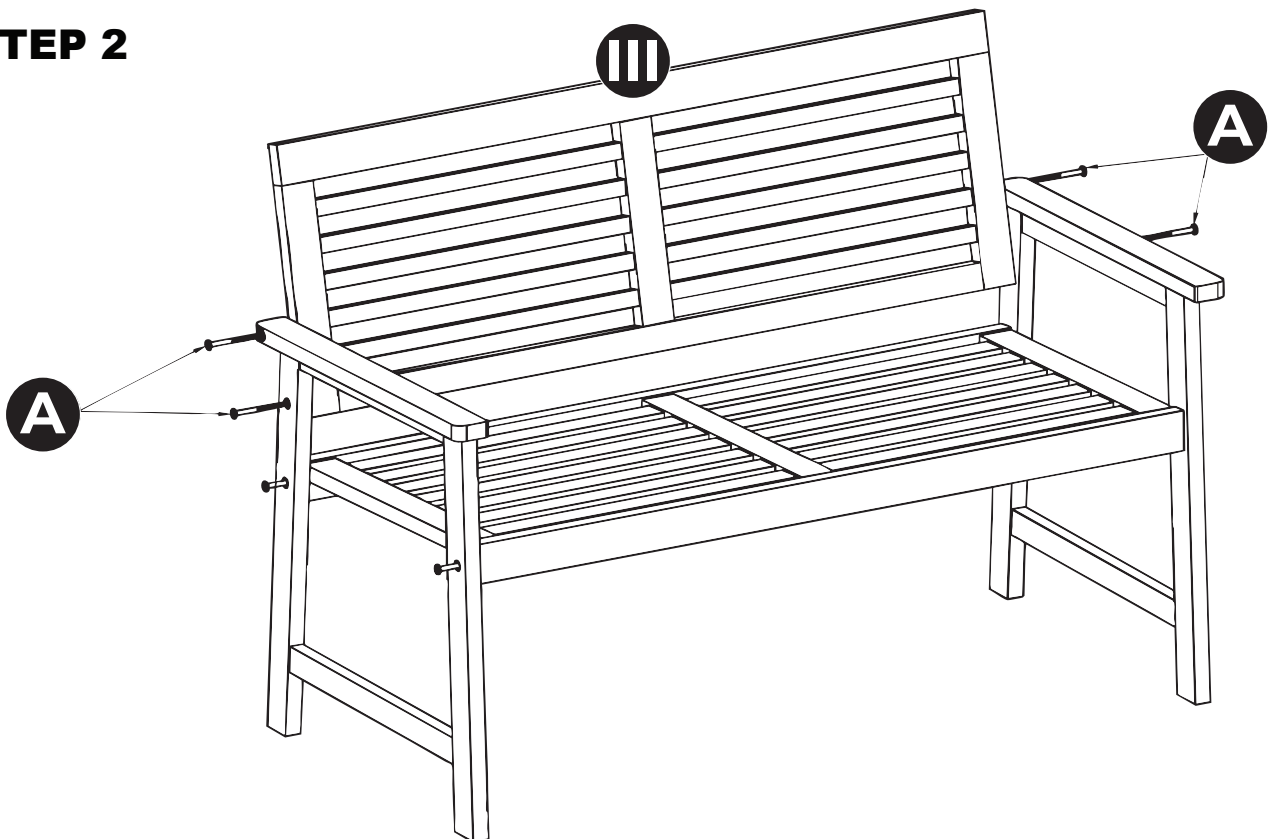

**STEP 3**

