

ASSEMBLY INSTRUCTIONS

TWIN

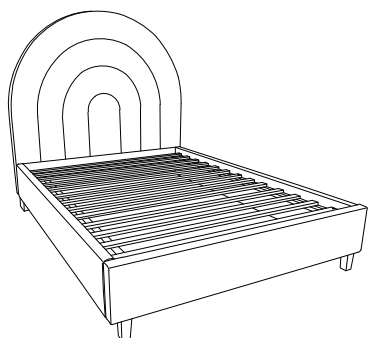

+ Do Not Use Power Tools



+ Suggested Adults

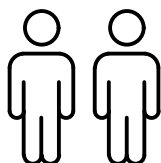

NOTE: For questions about parts or assembly please email support@meridianfurnitureusa.com or call us at 718-758-4455.

- 1 Read instructions cover to cover.
- 2 Save all packaging until assembly is completed.

1 IMPORTANT SAFETY INFORMATION

Do not assemble the product if any of the following parts arrived damaged:

1. Headboard Panel
2. Footboard Panel
3. Side Rail
4. Leg
5. Slats(13pcs)

2 IMPORTANT ASSEMBLY INFORMATION

Assembly Step Ensure the side rail bracket is fully hooked onto bolt loosely threaded with both washers on the OUTSIDE of the bracket first, then proceed to fully tightening all 4 corners.

+ Parts Included

① Headboard Panel
(1 pc)

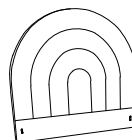

② Footboard Panel
(1 pc)



③ Side Rail
(2 pcs)

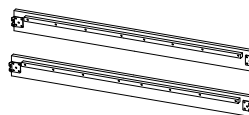

④ Leg
(4 pcs)



⑤ Slats(13pcs)
(1 pc)



+ Hardware Included

A. Allen Key M5
(1 pc)



B. JCBB Bolt
M8 x 16mm
(8 pcs)



C. CBS Screw
M4 x 32mm
(6 pcs)



ASSEMBLY INSTRUCTIONS

TWIN

1

Leg inside the headboard pocket

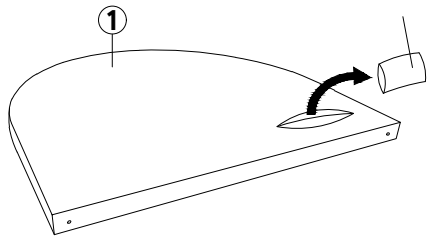

2

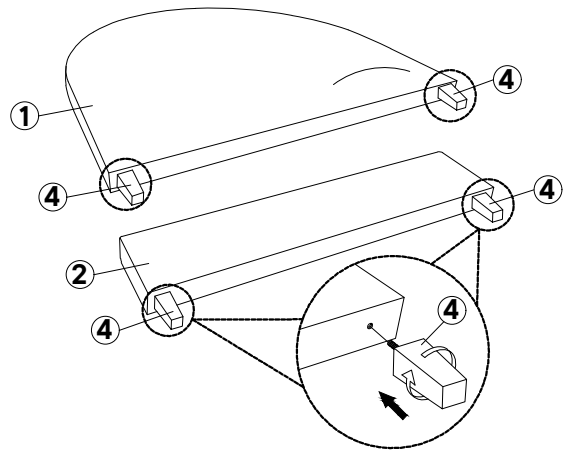

3

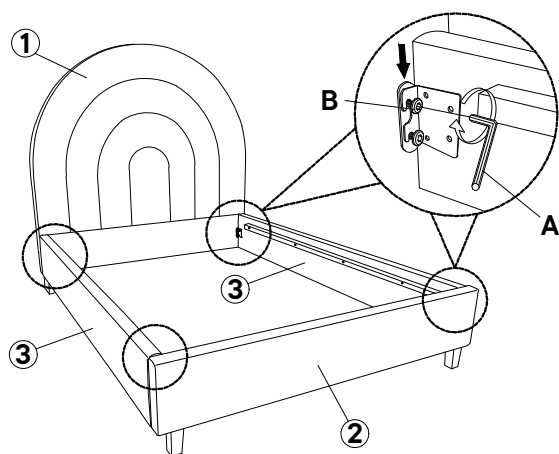

4

