

Assembly Instruction

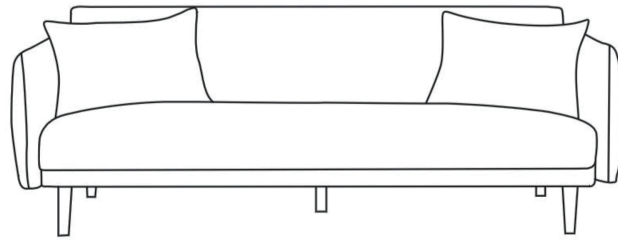

A

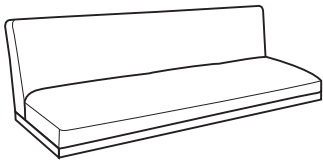

x1

B

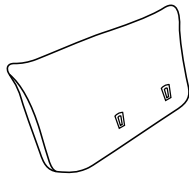

x2

C

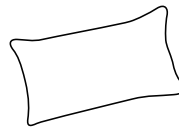

x2

D



x5

STEP 1

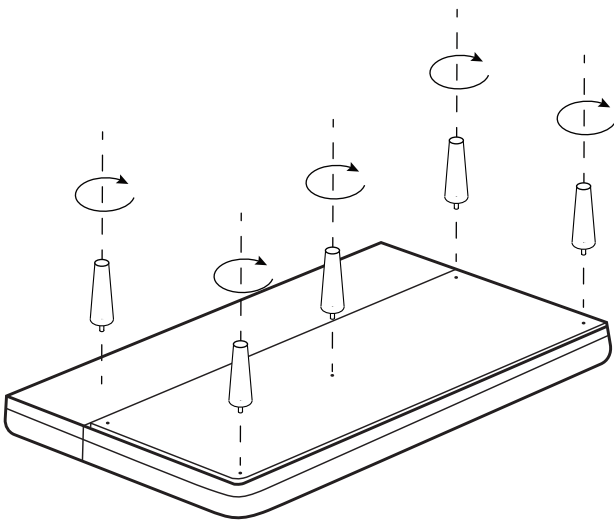

STEP 2

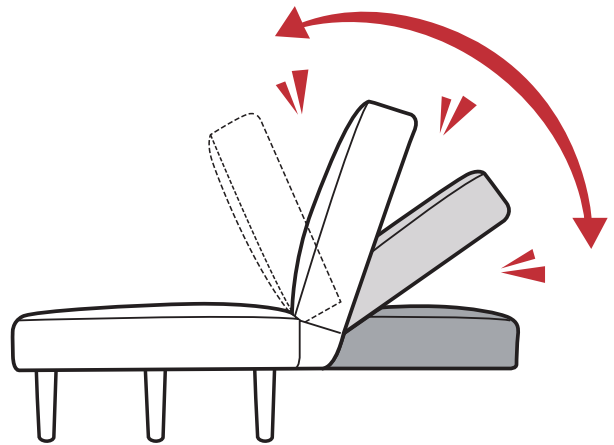

STEP 3

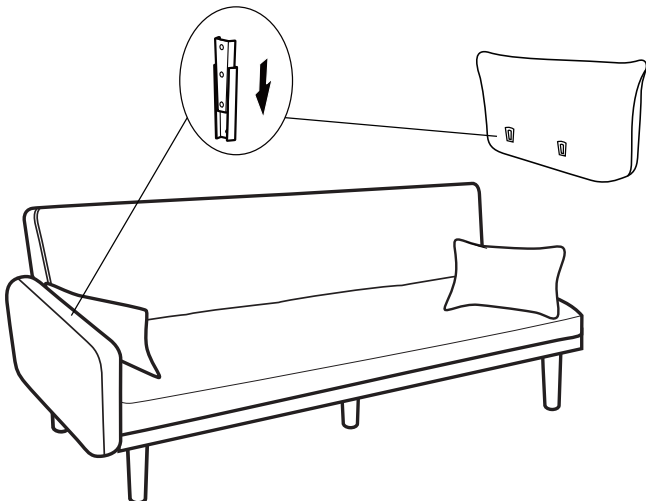

STEP 4

