

INSTRUCTION MANUAL

Lotus Pendant Light

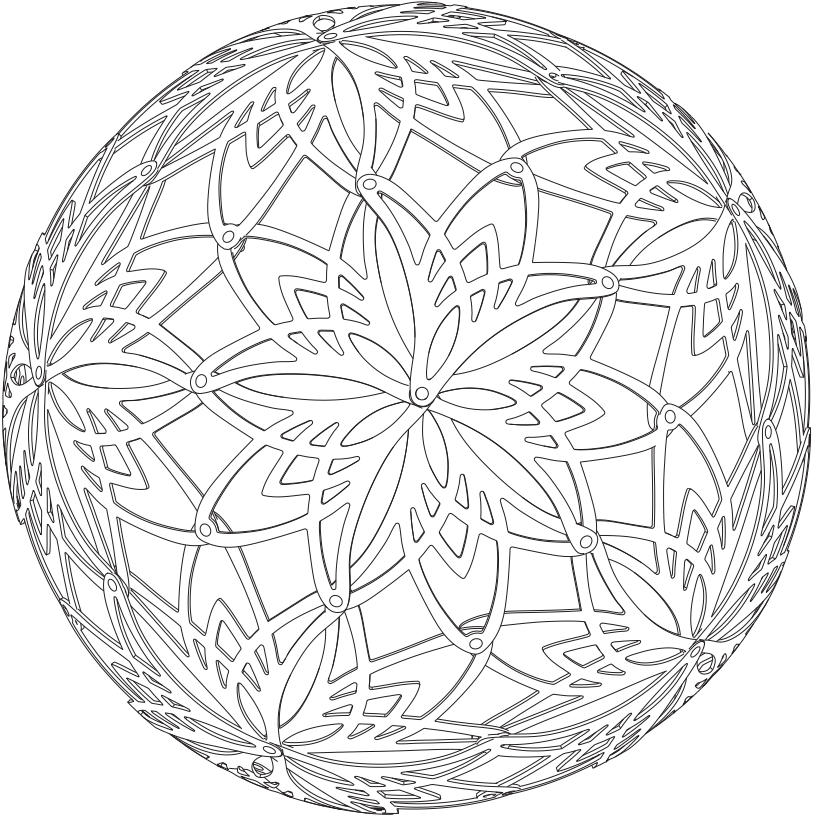

Made in China

Exclusively for World Wide Creations

Patents Pending

Introduction

Thank you for purchasing the Lotus Penant Light. This product is made of high quality materials and is intended to last. The Light comes in three versions: a plugin pendant version, a hard-wired pendant version, and a solar light version. **Read all safety warnings, instructions, and illustrations provided in this manual.** Failure to do so may result in electric shock, fire and/or serious injury or death.

Safety Language and Symbols

This instruction manual uses the following safety alert symbols and words to alert you to hazardous situations and your risk of personal injury or property damage.



▲ WARNING: Indicates potentially hazardous **could** result in **death or serious injury**.

Product Use

Your product is designed for use in a variety of environments.

DO NOT use under wet conditions or in presence of flammable liquids or gases.

DO NOT let children come into contact with the product. Supervision is required when inexperienced operators use this product.

DO NOT attempt to install the hard-wired version of the Lotus Pendant Light yourself. Such an installation **must be performed by a licensed electrician.**

Specifications

Model: Lotus

Diameter: 18 in. (457mm)

Power: 120V, 12A

Important Safety Instructions

▲ WARNING: RISK OF ELECTRICAL SHOCK

This product involves electricity. Like any other electrically powered device, if it is not used properly it may cause electric shock. Never operate the product outdoors when it is raining or in wet conditions. Repairs attempted by unqualified personnel can result in serious injury or death by electrocution. Any repairs required on this product should be performed by authorized service center personnel.

Electrical Grounding: Failure to provide adequate grounding to this product could result in serious injury or death from electrocution. Make certain that the electrical circuit to which the product is connected provides proper electrical grounding, correct voltage and adequate fuse protection.

▲ WARNING: RISK OF UNSAFE OPERATION

- Become familiar with the operation of this product.
- Keep operating area clear of all persons, pets, and obstacles.
- Keep children away from the product at all times.
- Never defeat the safety features of this product.
- Never attempt to hang anything other than the Lotus Pendant Light from the power cord.
- Do not operate with missing, broken, or unauthorized parts.
- Install eye hook into a ceiling joist away from any electrical or water lines.
- Never install eye hook into ceiling or wall without a joist behind (it may weaken and fall over time).

Unpacking

Remove parts from carton and discard all packaging.

Location Selection

- Locate the Lotus Pendant Light in a clean, dry and well ventilated area.
- The Light should be located at least 12" (30.5 cm) away from ceiling, walls or other obstructions.
- Never install Light directly above an appliance (stove, sink, dryer, etc.).

Parts for the Plugin Pendant Version

After unpacking, inspect parts carefully. If a part is missing or damaged, contact us directly at (810) 686-8252 for replacements.

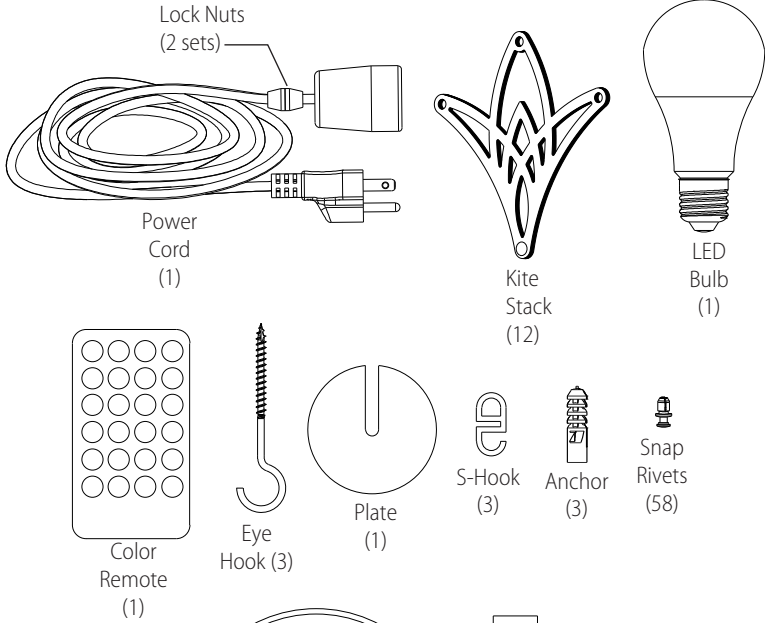

Additional Parts for the Hard-wired Pendant Option



▲ WARNING: All ELECTRICAL PARTS are to be handled and installed by a **LICENSED ELECTRICIAN ONLY.**

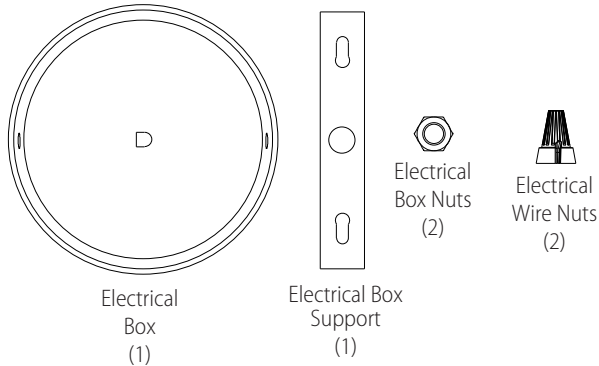

Or Parts for the Solar Light Option

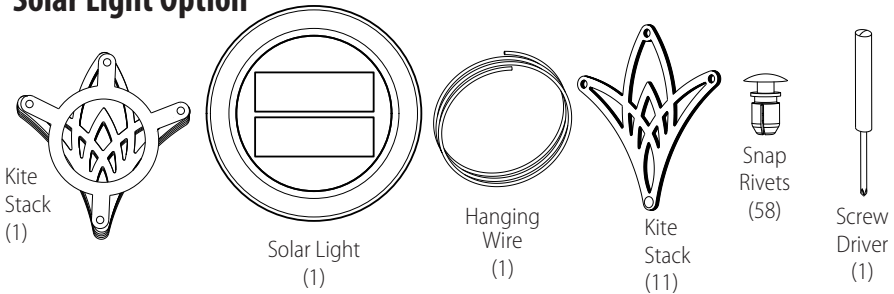

Using Snap Rivets

Each Snap Rivet has three parts: a cap, a tip and a pin. Insert Tip of Snap Rivet into a hole and completely push the Snap Rivet through all face layers and then squeeze both sides with your fingers until a 'click' is heard.

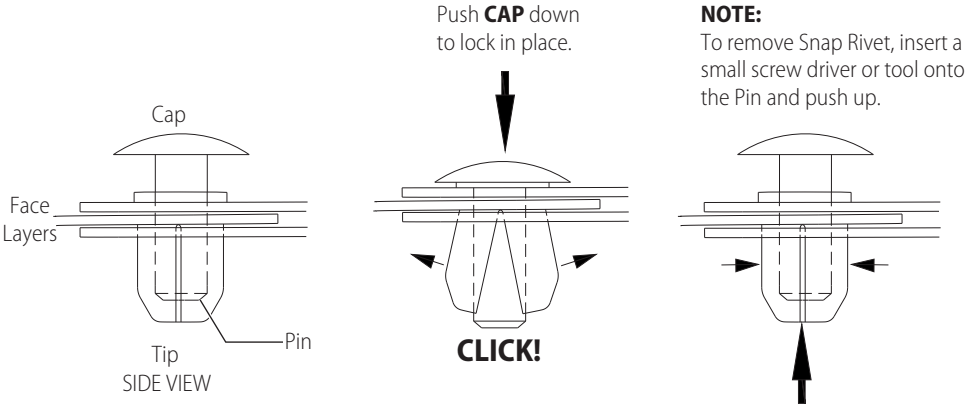

NOTE: Snap Rivet Cap must always face outside the lamp during assembly.

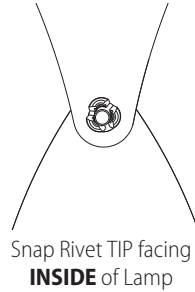
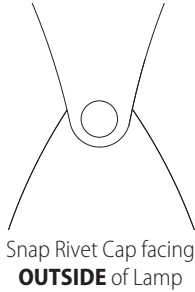

Key Points to Remember Before you Begin

Each Kite tip must be connected in a specific way.

"4...3...4"



Remember this Golden Rule!

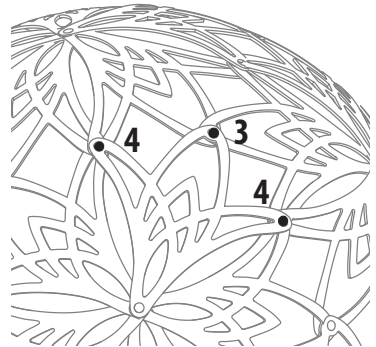
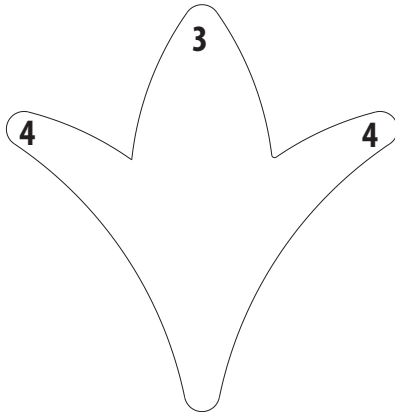

4 = Pointed Side tips have **4** connection layers.

3 = Round Center tips have **3** connections layers.

Assembly

Each Kite tip must be connected in a specific way.

- 1 Spread each of the 12 **KITE STACKS** open to prepare them for assembly as shown.

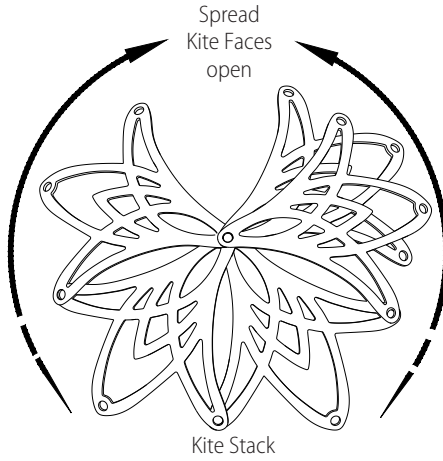

- 2 Connect **FIRST KITE STACK** to **SECOND KITE STACK** with **SNAP RIVET** as shown.

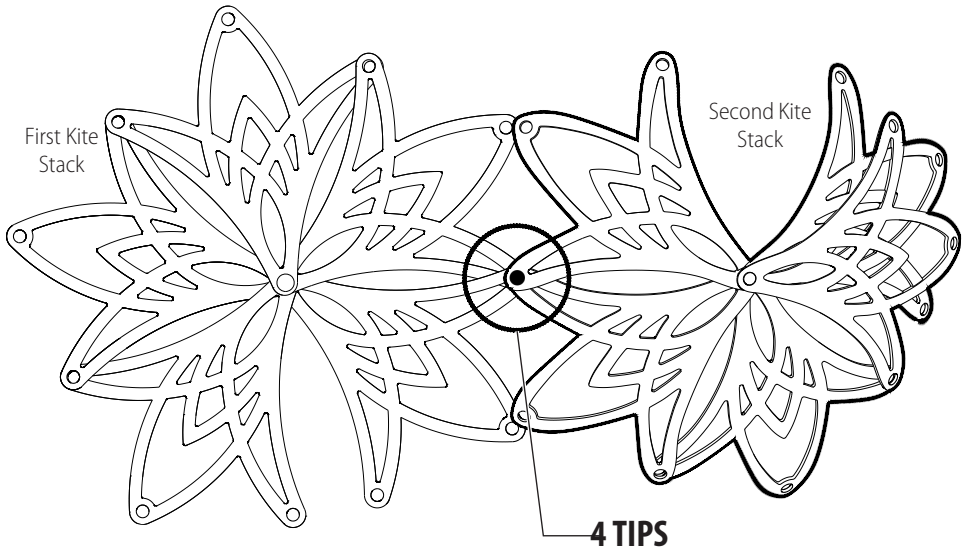

3

Connect **THIRD KITE STACK** to **SECOND KITE STACK** with **SNAP RIVET** as shown.

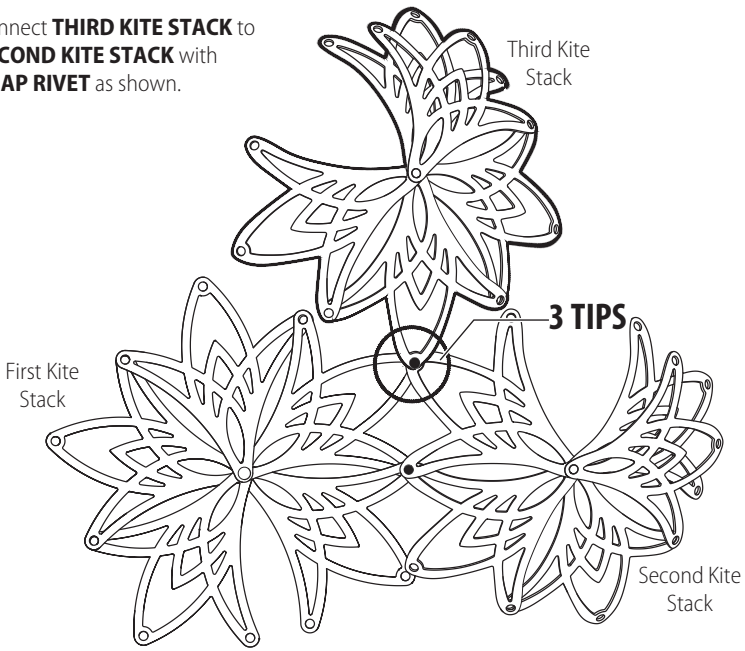

4

Connect **FOURTH KITE STACK** to **FIRST KITE STACK** with **SNAP RIVET** as shown.

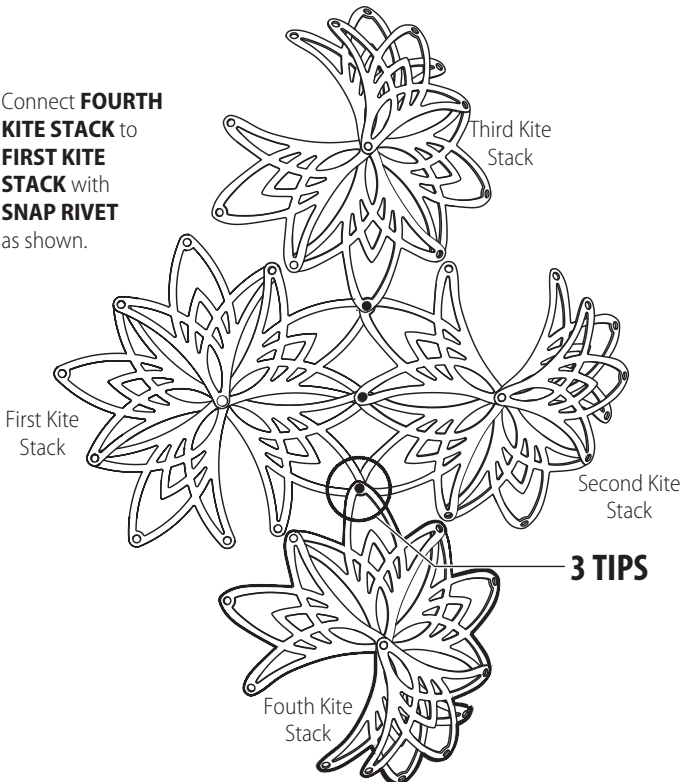

6

Complete face assembly. Do not connect the final tips with a **SNAP RIVET** before step 7.

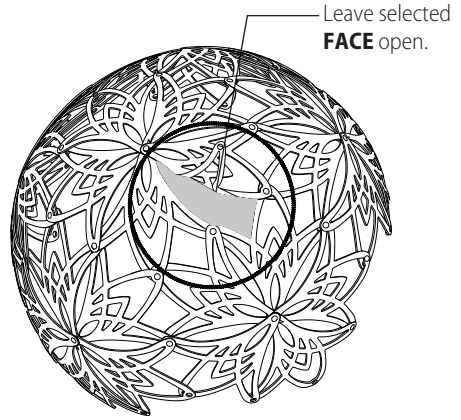
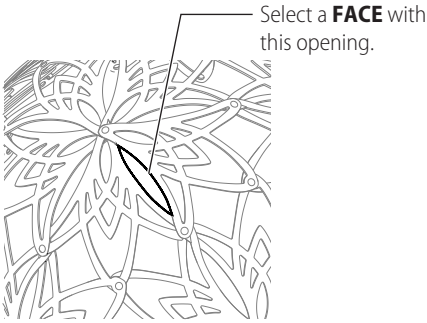

7

Slide **PLATE** over **POWER CORD** and install **LED BULB**.

NOTE:

The LED Bulb will be at center of the lamp when the Power Cord is approx. 1-inches below the Plate; however, this can be adjusted to suit your preference. (the light is thrown better when the LED bulb is closer to the top of the light).

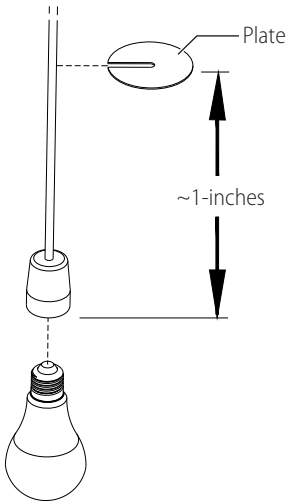

8

Lock the Plate to the Power Cord by sandwiching the Plate between the two sets of **LOCK NUTS** on the Cord.

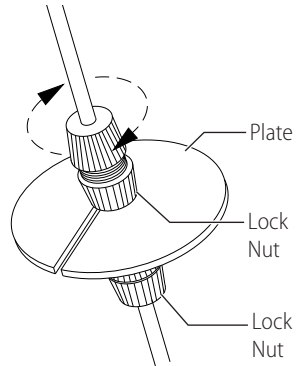

NOTE:

Spin the top half of Lock Nuts to clamp down on Power Cable and Plate.

9

Insert **LED BULB** assembly into final opening with **SNAP RIVET** and connect the opening. Allow lamp to hang on **PLATE**.

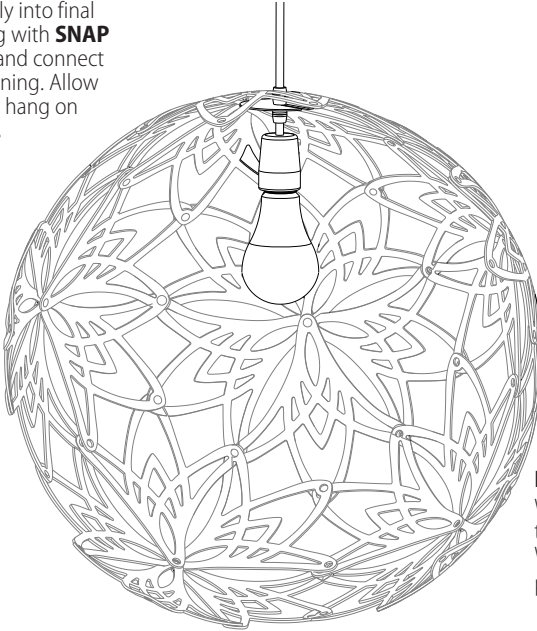

Cut Away View



⚠ WARNING: Hard-wired version of the Lotus Pendant Lamp is to be installed by a **LICENSED ELECTRICIAN ONLY**.

NOTE:

When using the light, turn on the switch on the Power Cord. When using Remote, always position it **BELOW** the lamp.

10

Install **EYEHOOKS** into ceiling and hang **POWER CORD** from **EYEHOOKS** using the **S-HOOKS** as shown. If the ceiling is a rigid material other than sheet rock, drill a hole and insert **ANCHORS** to hold **EYEHOOKS**.

NOTE:

Check to be sure there are no electrical or water lines in ceiling before installing Eyehooks.

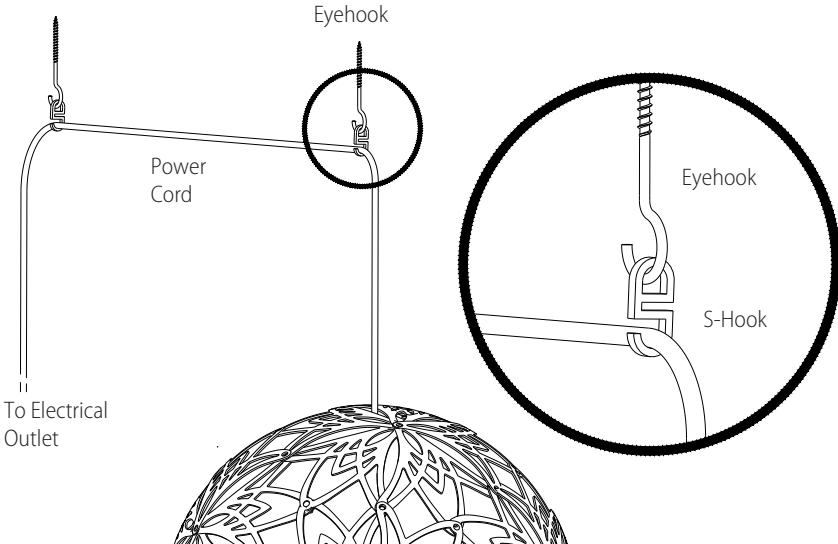

Solar Option Assembly

- 1 Turn on the **SOLAR LIGHT** by removing the **PULL TAB** and pressing the **ON** button on the bottom.

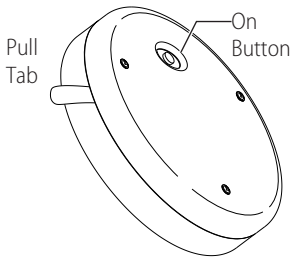

NOTE:

If the light does not turn on in the dark, open the case using screw driver and be sure battery is installed properly.

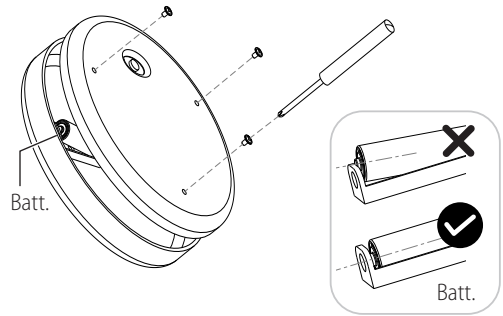

- 2 Insert into the **SOLAR LIGHT** Circular Face.

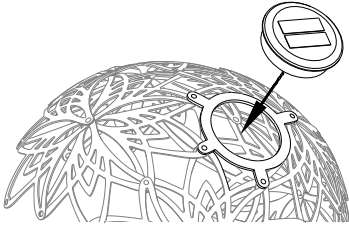

- 3 Position the Solar Light on the upper portion so it drops into the Circular Face and remains in place.

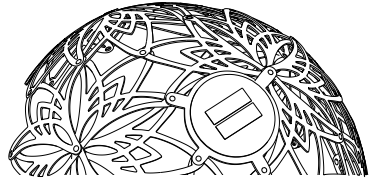

Using the Solar Light

- The Solar Light has a sensor that detects when its dark and automatically turns the light on.
- Locate the Lotus Solar Light in an area pointed at the sun for maximum charge.
- Use Hanging Wire to hang the Lotus Solar light by bending a hook on each end - we suggest an upside down 'U' or upside down 'V' that simply hooks into a four-layer intersection of a riveted face of the solar light and making it as long as desired for your location.
- If the light fails to activate at night, ensure ON button is pressed - if this does not work the battery may be dead and the Solar Light will need to be replaced (do not attempt replacing battery).
- Hang the Lotus Solar Light near entryways, sidewalks and walkways and it will cast a beautiful light.
- The Lotus Solar Light can be located in the landscape on the ground or in trees - use the Hanging Wire to hang it on a branch, a screw or nail.



NOTE:

Attach wire into a four-layer intersection, adjust wire to desired length in your location. Keeping in mind where the sun will charge the lamp and where the lamp will cast its shadows.

Refunds and Warranty

For refunds or If a part is missing or damaged, contact us directly for support.

Maintenance

Occasionally inspect the Eyehooks and tighten if necessary. If the Power Cord becomes frayed immediately remove the lamp from service. Clean the lamp with a damp cloth and unplug before cleaning.

Disclaimer

This manual relates solely and exclusively to the Lotus Pendant Lamp including but not limited to the operation thereof. Failure to adhere to this manual or to properly focus on the operation of the Lotus Pendant Lamp can result in serious injury and even death. Always operate the Lotus Pendant Lamp in a safe manner and in full compliance with this manual. We are not liable for any injuries or damages to any operators, property, or bystanders incurred as a result of using this product. We also cannot be held liable for any and all errors in this manual or for any incidental or consequential damages that result from the use of the material presented in this manual. This manual contains proprietary information belonging solely to us. All rights are reserved. No part of this manual may be photocopied, reproduced or translated to another language without the written consent of us.