

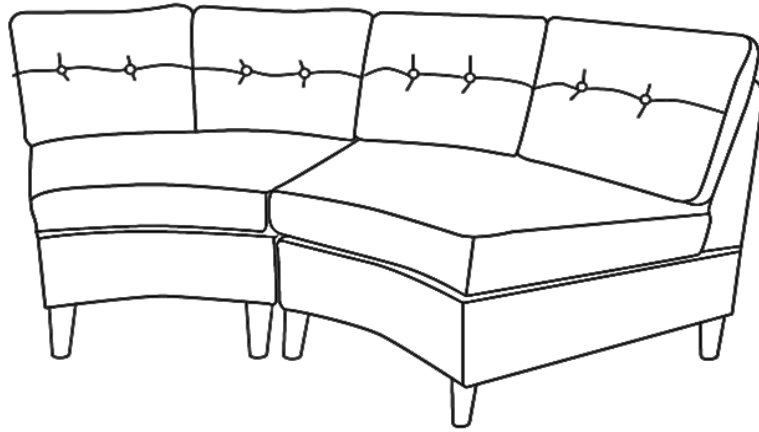

Assembly Instructions

Caution :You must read this before you proceed





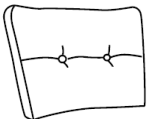
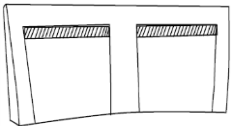

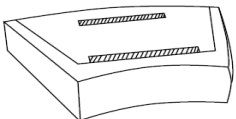
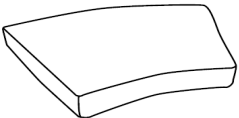

HALF ROUND SOFA



Parts List

Label	Picture	Description	QTY
A		Back Cushion	4
B		Backrest	2
C		Leg	8
D		Sofa Seat	2
E		Seat Cushion	2

Hardware

Label	Picture	Description	QTY
①		Nut	5
②		Allen key	1
③		Socket Wrench	1
④		Connecting Piece	3
⑤		Double Head Screw(M8*70MM)	5
⑥		Bolt(M8*20MM)	4
⑦		Flat Washer	9
⑧		Spring Washer	9
⑨		Plastic Washer	14

Assembly Preparation

Before Beginning Assembly:

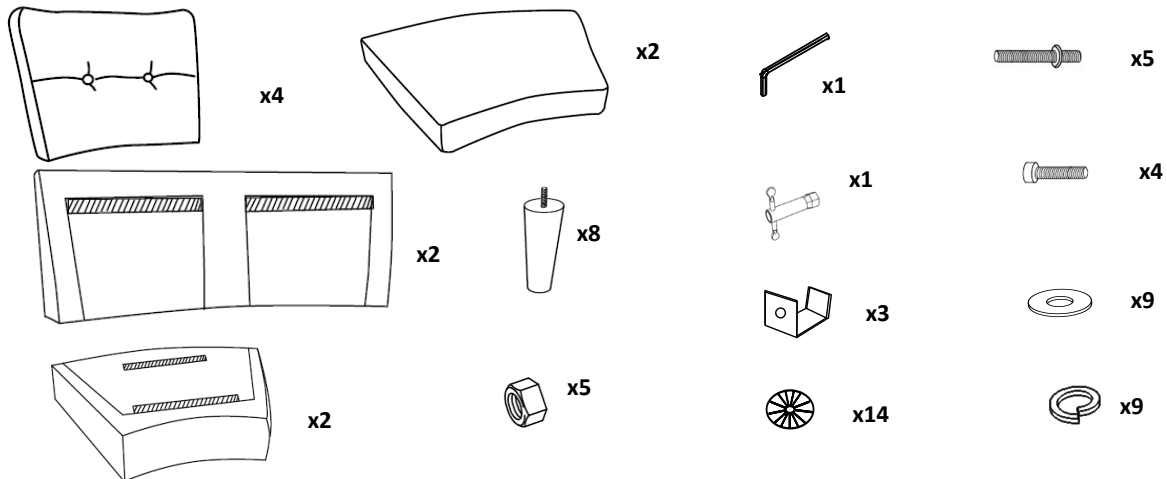

- Read instructions, cover to cover-



- Have 2 adults on hand for assembly-



- Do not assemble on flooring or carpet-



- Assemble on a clean non-marring surface (packing foam)-



- Save all packaging until finished-

Assembly Steps

OVERVIEW

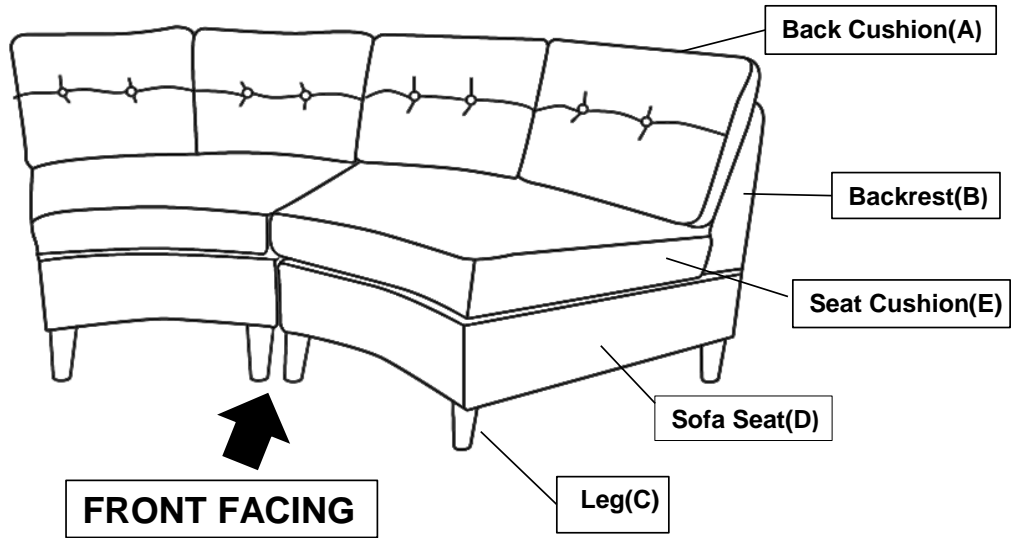

This HALF ROUND SOFA has multiple parts and may require up to some 30 minutes to assemble. To give you an overview of the sofa parts, the above picture is to help you put the various parts into perspective. Please read through the instructions below to familiarise yourself with the parts and steps before assembly.

Step 1

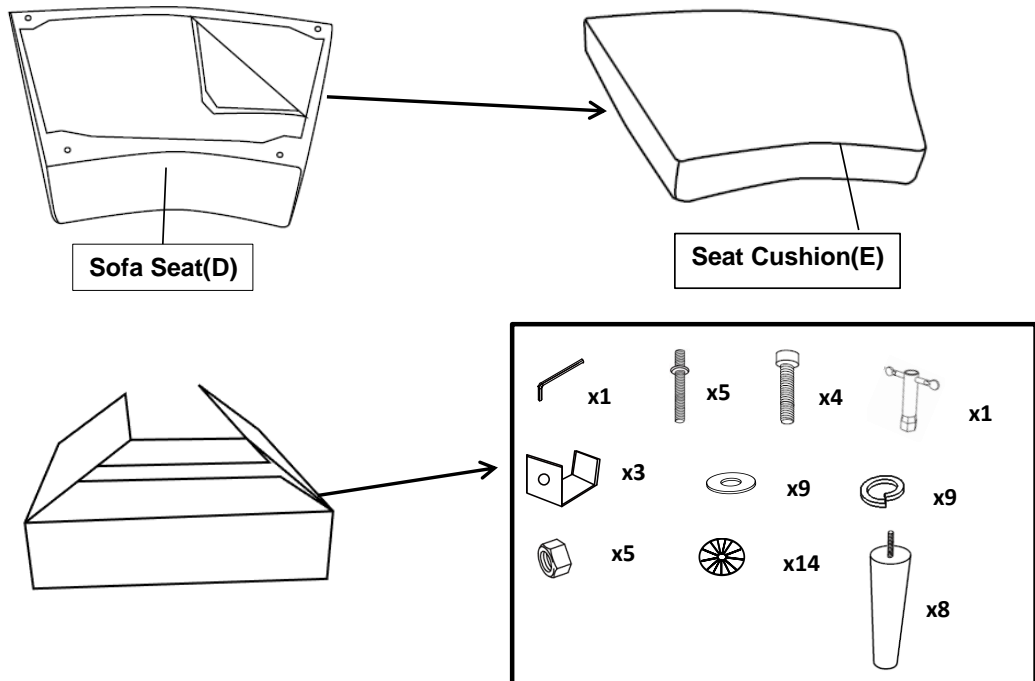

Place the Sofa Seat(D) on a clean,non-marring surface,as shown above. Take out the Seat Cushion (E),4 wooden legs and Hardware the bottom of the Seat (D),as above picture shown on.

Step 2

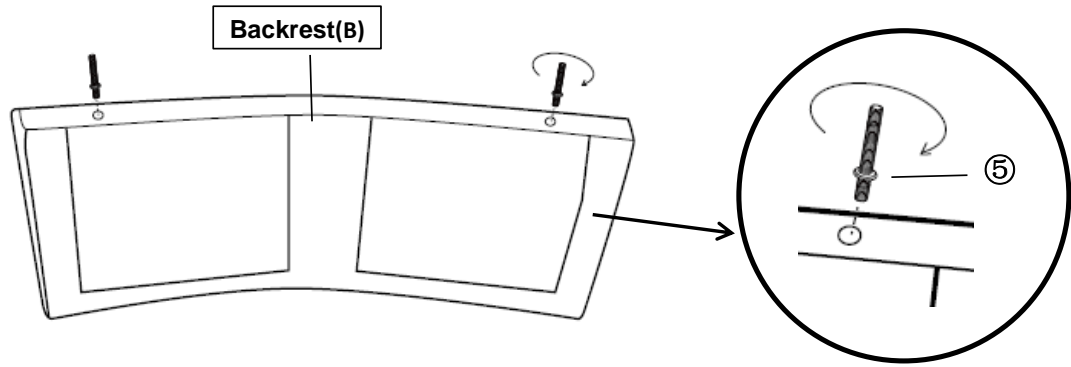

Position the Backrest(B) upside down and lay on a clean, non-marring surface. Screw the Double Head Screw(5) into mounting position on the bottom of Backrest(B) by hand, turned clockwis.

Step 3

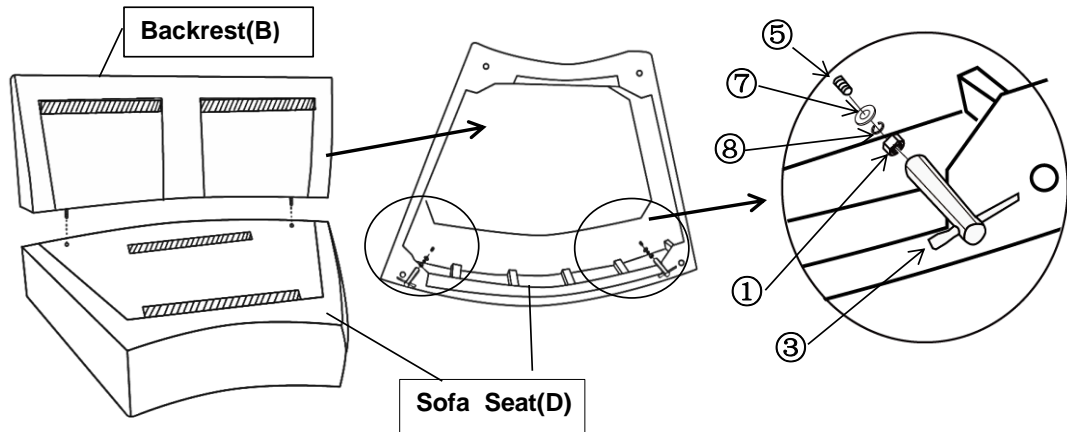

Align the mounting positions on the outside facing of the Sofa Seat(D) and the Backrest(B).

Insert the Backrest(B) into the Sofa Seat(D) using Flat Washer (7), Spring Washer (8), Nut (1) and Double Head Screw (5), as shown in above picture.

Step 4

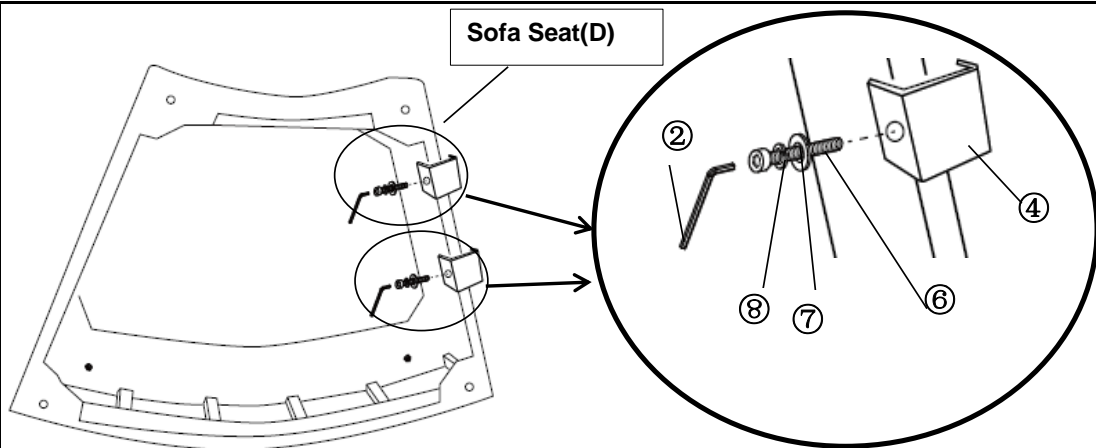

Install the Connecting Piece (4) to the Sofa Seat(D) using Bolt(6), Flat Washer(7) and Spring Washer(8) with Allen Key(2). Fully tighten it until secure.

Step 5

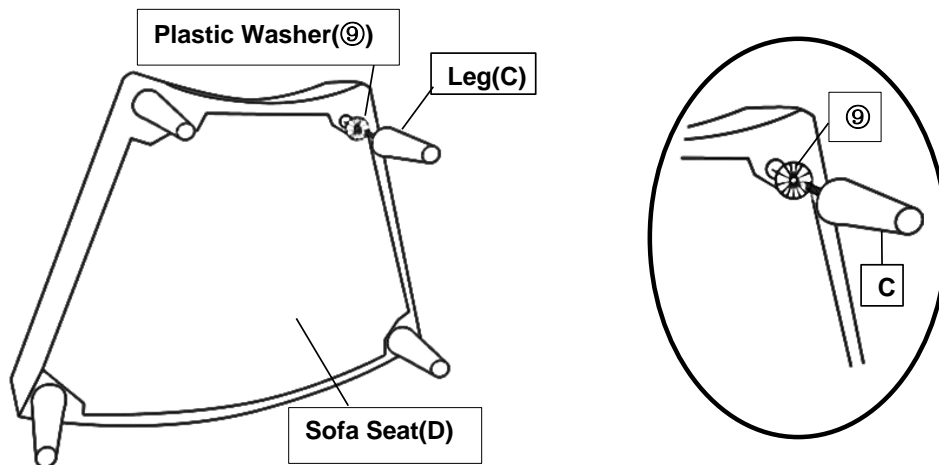

Install the Leg(C) to the Sofa Seat(D) by placing a Plastic Washer(9) onto the threaded stem of the Legs.

And then insert the threaded stem into the threaded mounting position at each Corner of the Bottom of the Sofa Seat(D).

Tighten by turning the Legs clockwise.

Note: The use of Sofa Seat(D) are OPTIONAL and are especially useful to help alleviate slight wobbles.

Some Legs may need more than one Plastic Washer whilst some Legs may not need any.

Position sofa right side up and test for stability on a Level Surface.

Add or remove Plastic Washer(9) where needed to achieve stability.

Step 6

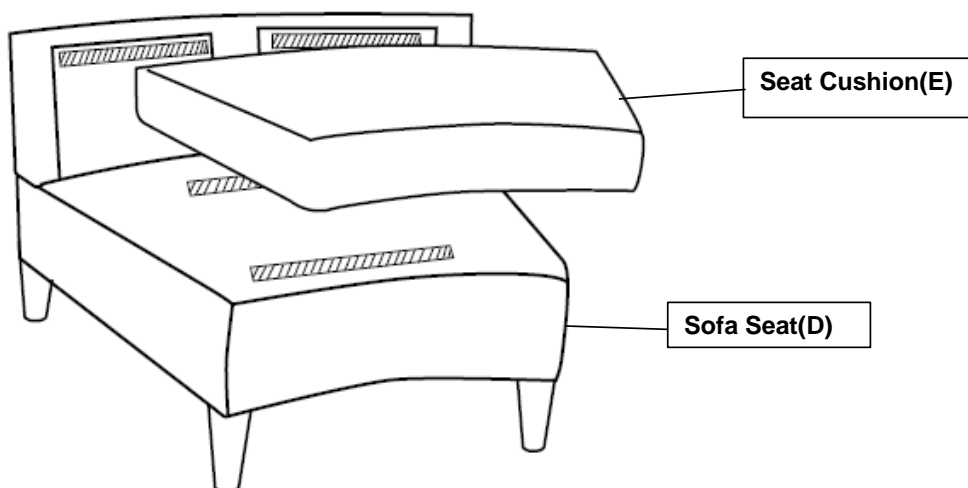

Put the Seat Cushion(E) on the Sofa Seat(D).

Step 7

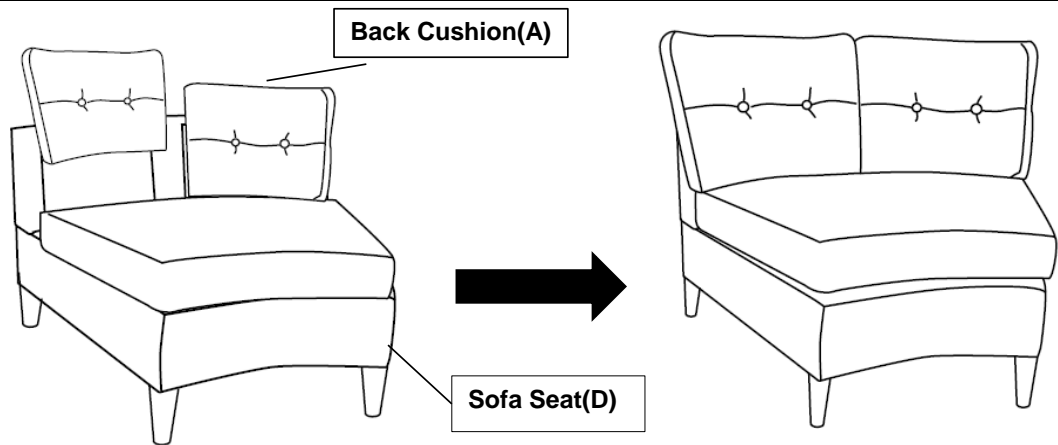

Put the Back Cushion(C) on the Sofa Seat(D).

Step 8

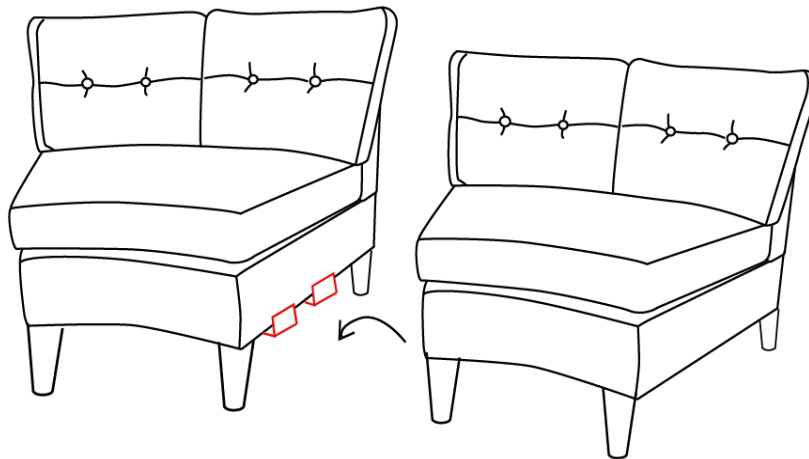

Repeat the same steps to assembly another Sofa.
After finished this 2pcs Sofas assembly, connecting the two sofas by using the pre-fixed Connecting Piece (④) as shown.

Step 9

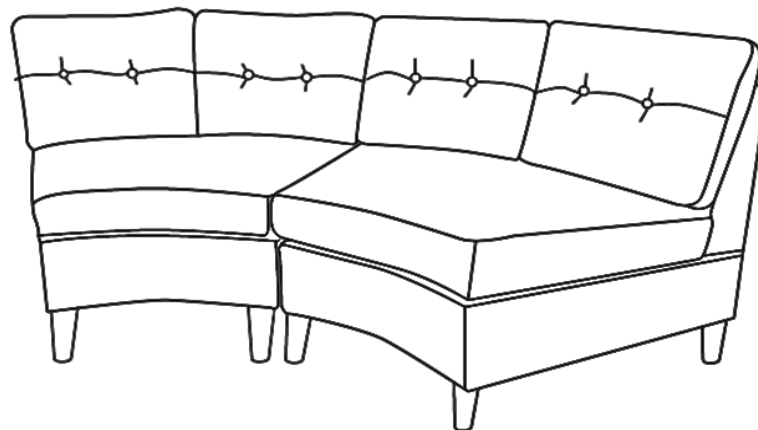

Your Sofa is ready for use.
Your Sofa can only be used on a flat, level surface.





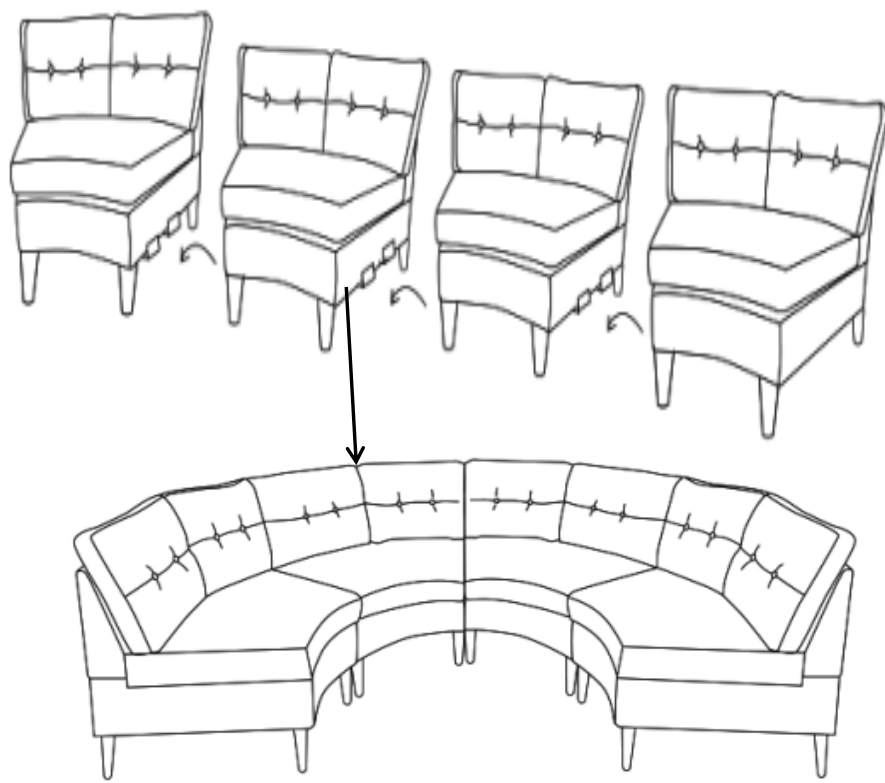















If you already purchased 2 or more than 2 products, Please read on.

Step 1



Connecting the two sofas by using the pre-fixed Connecting Piece as shown in the picture.

Care & Maintenance

-   ● Do not put hot items directly on furniture surface
 -   ● Do not clean furniture with harsh cleansers or polish.
 -   ● Do not place furniture under direct sunlight.
 -   ● Do not place furniture near heating or cooling vents.
 -   ● Do not write on furniture without a padded barrier to protect the surface.
 -   ● Do not place furniture outside . For indoor use only .
 -   ● Not for commercial use. For residential use only .
 -   ● Stains may be removed with mild soap solution and damp cloth.
 -   ● Children should not climb or jump on the furniture.
-
-   ● Dust and pick-up spills using a clean, non-colored, lint-free cloth .

Questions & Answers about Proposition 65

• What is Proposition 65?

Proposition 65 requires businesses to provide warnings to Californians about significant exposures to chemicals that cause cancer, birth defects or other reproductive harm. These chemicals can be in the products that Californians purchase, in their homes or workplaces, or that are released into the environment. By requiring that this information be provided, Proposition 65 enables Californians to make informed decisions about their exposures to these chemicals.

Proposition 65 also prohibits California businesses from knowingly discharging significant amounts of listed chemicals into sources of drinking water.

Proposition 65 requires California to publish a list of chemicals known to cause cancer, birth defects or other reproductive harm. This list, which must be updated at least once a year, has grown to include approximately 900 chemicals since it was first published in 1987.

• What types of chemicals are on the Proposition 65 list?

The list contains a wide range of naturally occurring and synthetic chemicals that include additives or ingredients in pesticides, common household products, food, drugs, dyes, or solvents. Listed chemicals may also be used in manufacturing and construction, or they may be byproducts of chemical processes, such as motor vehicle exhaust.

• What does a warning mean?

If a warning is placed on a product label or posted or distributed at a workplace, a business, or in rental housing, the business issuing the warning is aware or believes that it is exposing individuals to one or more listed chemicals.

By law, a warning must be given for listed chemicals unless the exposure is low enough to pose no significant risk of cancer or is significantly below levels observed to cause birth defects or other reproductive harm.

• Where can I get more information on Proposition 65?

If you have specific questions on the administration or implementation of Proposition 65, you can contact OEHHA's Proposition 65 program at P65.Questions@oehha.ca.gov, or by phone at (916) 445-6900.