

Assembly Instructions

Caution : You must read this before you proceed

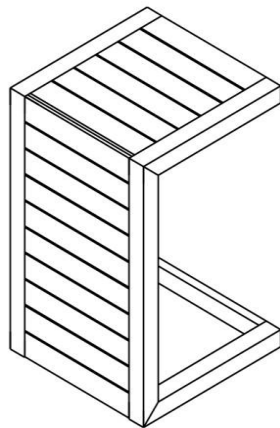

Table

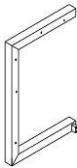
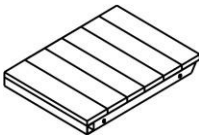
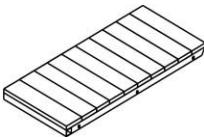
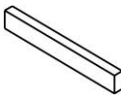

Parts List

Label	Picture	Description	QTY
A		Side Support Bar	2
B		Top Panel	1
C		Side Panel	1
D		Horizontal Base Support Bar	1

Hardware

Label	Picture	Description	QTY
①		Bolt:M6*20MM	11
②		Bolt:M6*25MM	3
③		Allen Key	1

Assembly Preparation

Before Beginning Assembly:

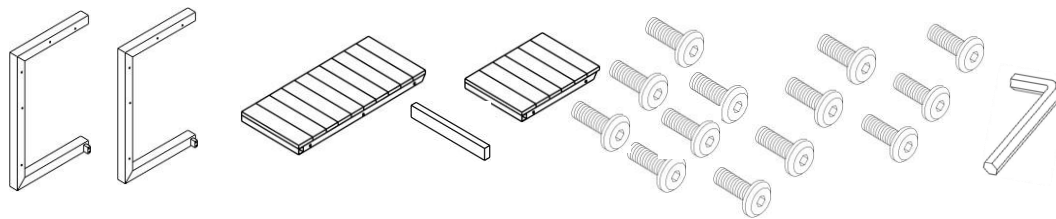

- Have 2 adults on hand for assembly-



- Do not assemble on flooring or carpet-



- Assemble on a clean non-marring surface (packing foam)-



- Save all packaging until finished-

Assembly Steps

Overview

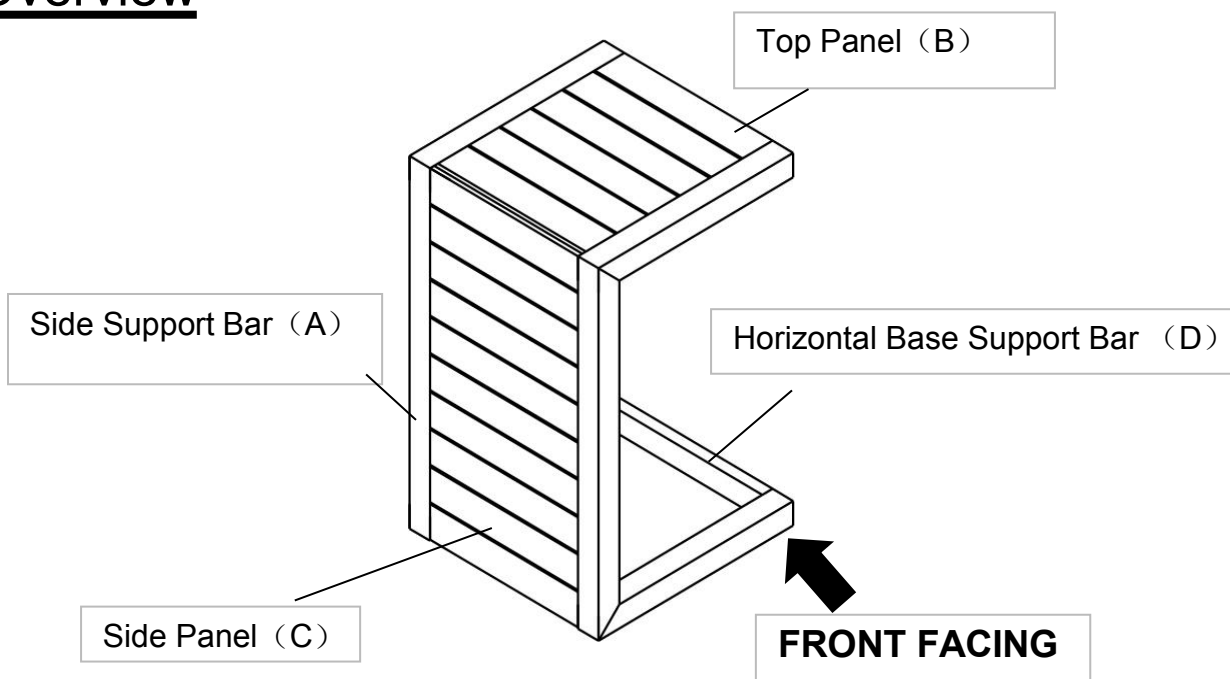

This Table has multiple parts and may require up to 30 minutes to assemble. To give you an overview of the Table parts, the above picture is to help you put the various parts into perspective. Please read through the instructions below to familiarise yourself with the parts and steps before assembly.

Step 1

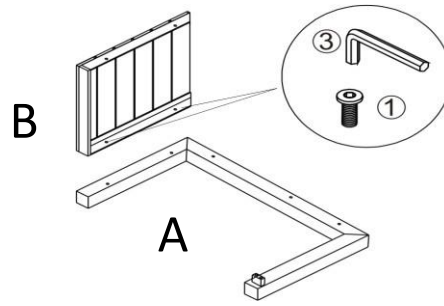

Open the carton and place all the parts onto a clean, non-marring surface.
Attach the Top Panel(B) to Side Support Bar(A) using Bolts(1) with Allen Key(3) as shown above.

Do not fully tighten Bolts.

Step 2

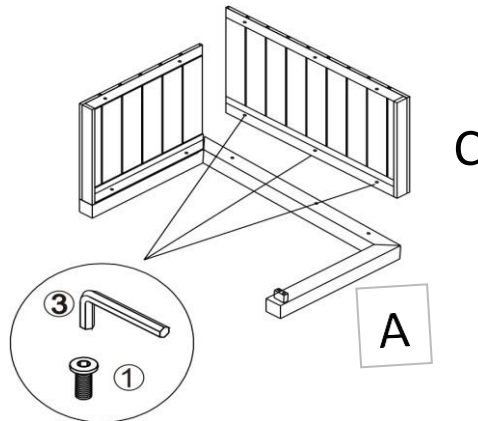

Attach the Side Panel(C) to Side Support Bar(A) using Bolts(1) with Allen Key(3) as shown above.

Do not fully tighten Bolts.

Step 3

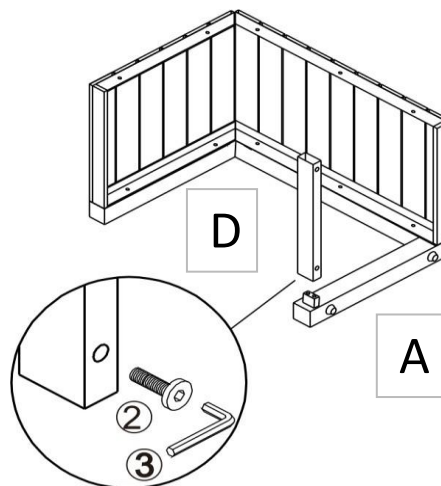

Attach the Horizontal Base Support Bar (D) to Side Support Bar(A) using Bolts(2) with Allen Key(3) as shown above.

Do not fully tighten Bolts.

Step 4

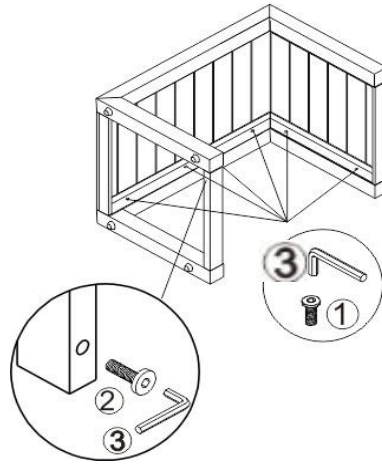

Attach the Side Support Bar(A) to Side Panel(C) and Top Panel(B) Horizontal Base Support Bar (D) using Bolts(①&②) with Allen Key(③) as shown above.

Do not fully tighten Bolts.

Step 5

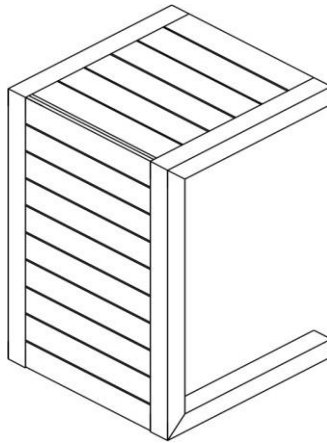

Stand the Table up. Place the Table on a LEVEL SURFACE.

Inspect it and make sure all parts are adequately connected.

Gently and carefully, sit onto the Table.

This will help to align all parts at all the joints. Then get off the Table, and in a sequential manner, proceed to tighten all Bolts.

When tightening the Bolts, tighten sequentially.

Do not tighten any Bolt fully before checking all of tops and legs are kept at the same level and then move on to the next one.



















This may cause the frame to warp. If there are still wobbles, loosen the Bolts and execute the same process.



If the Table is not stable it could lead to damage to the product.

Your Table is ready for use.

This Table can only be used on a flat, level surface.

Care & Maintenance

-   ● Do not put hot items directly on furniture surface
-   ● Do not clean furniture with harsh cleansers or polish.
-   ● To obtain the longest lifespan of your outdoor products, minimizing exposure to direct sunlight is recommended.
-   ● Children should not climb or jump on the furniture.
-   ● Do not write on furniture without a padded barrier to protect the surface.
-   ● To obtain the longest lifespan of your outdoor products, avoid extended and lengthy exposure to rain, snow, and direct sunshine. Whenever possible cover the product and /or place under patio or awnings.
-   ● Not for commercial use. For residential use only .
-   ● Stains may be removed with mild soap solution and damp cloth.
-   ● Keep away from sources of ignition.

-   ● Dust and pick-up spills using a clean, non-colored, lint-free cloth.