

# Assembly Instruction

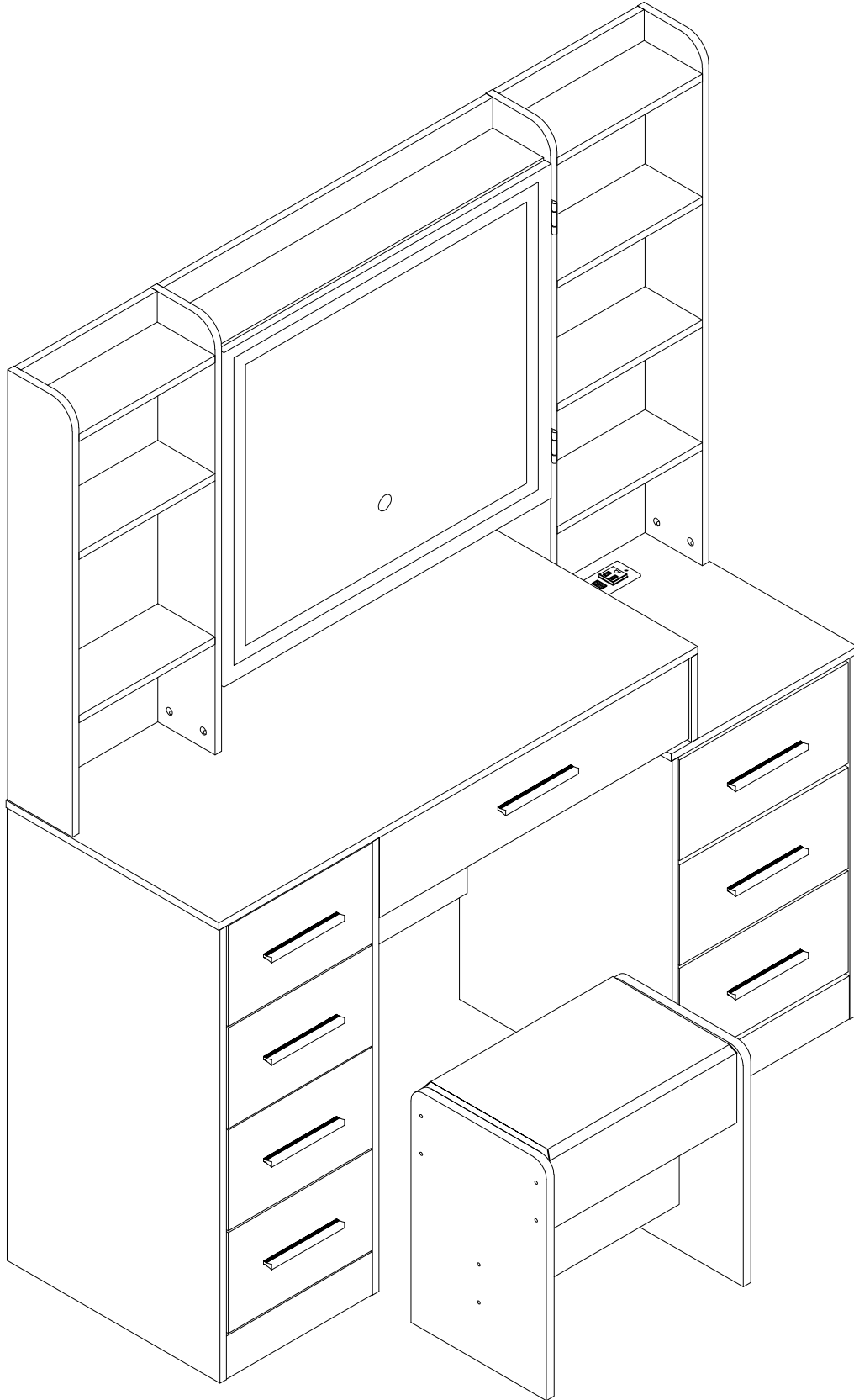

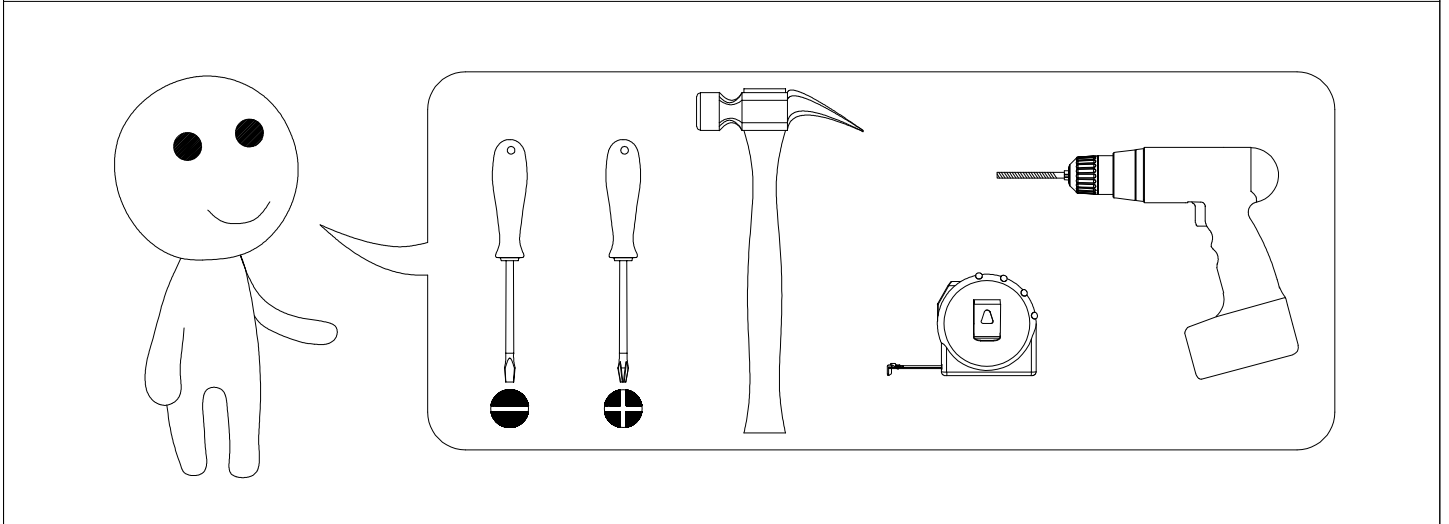

# PLATE NUMBER

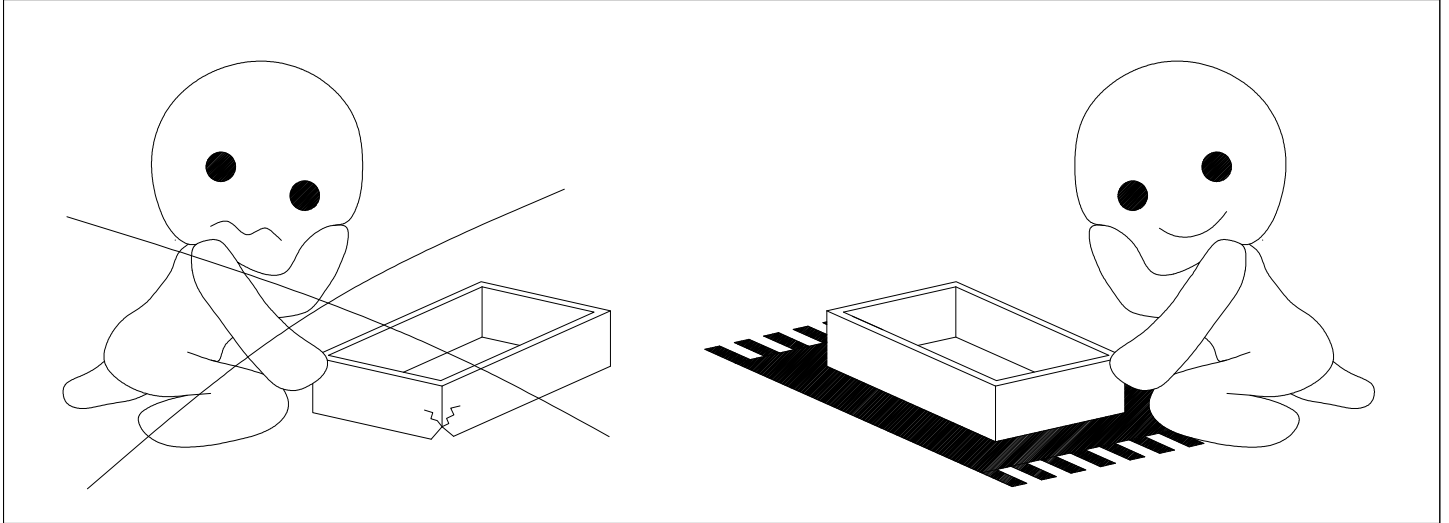
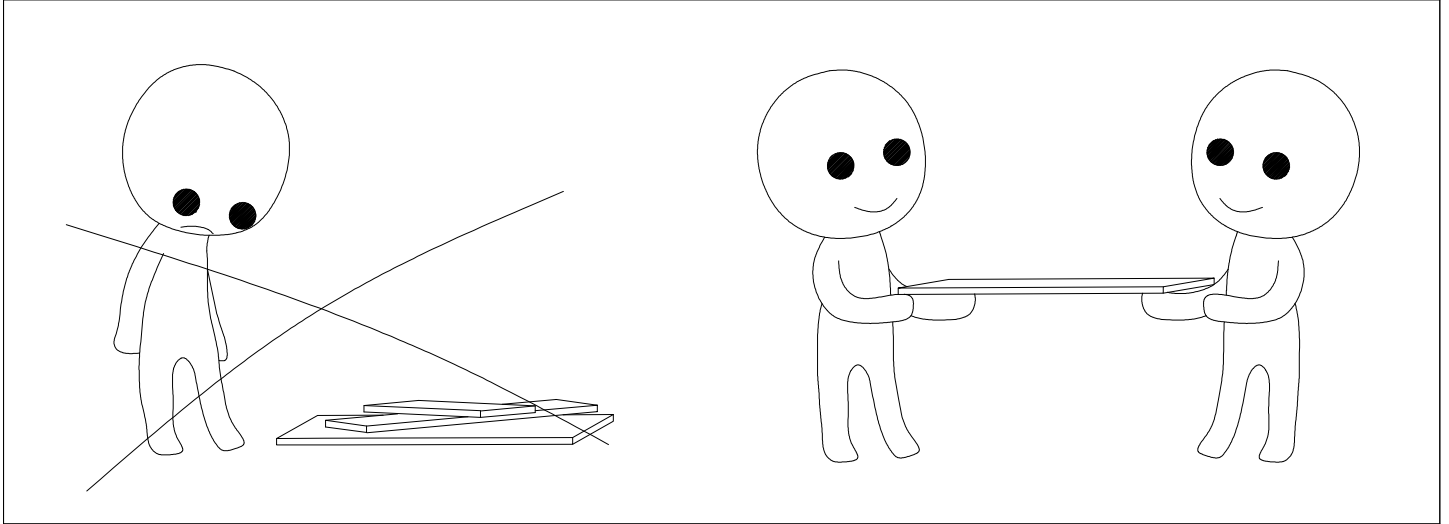
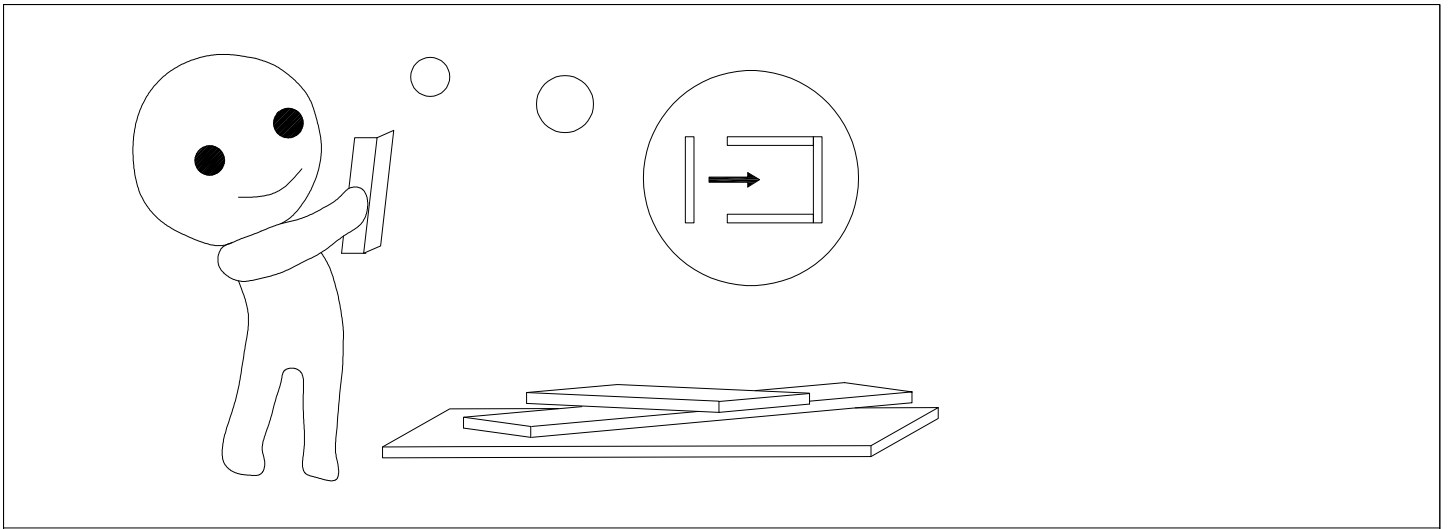
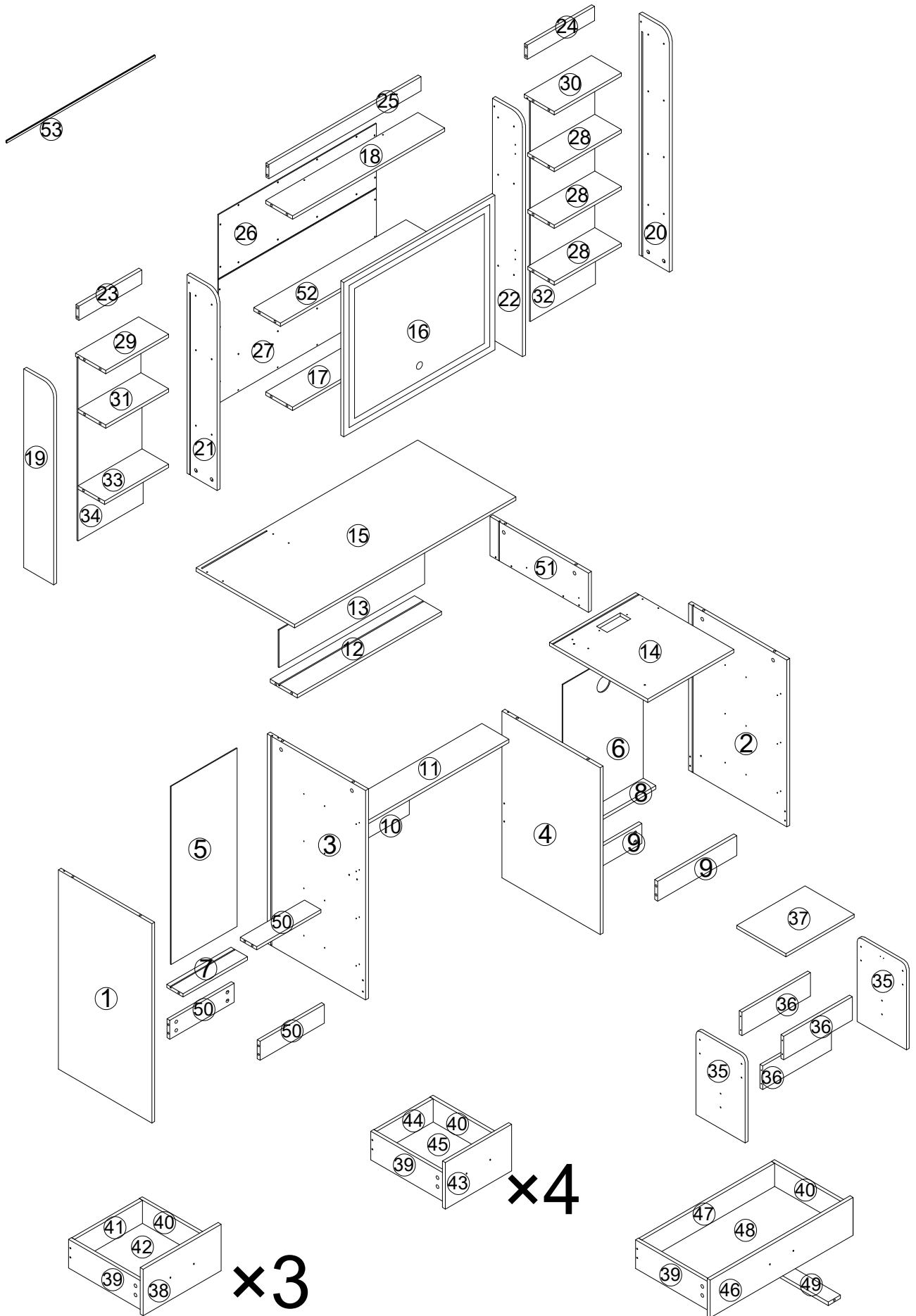

# ACCESSORIES LIST

A ×138

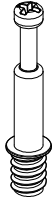

M6×35

B ×138

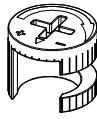

12×10

C ×47



M5×40

D ×128

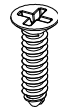

M3×12

E ×8

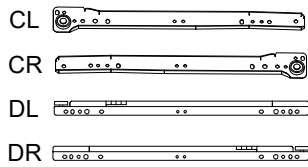

M300

F ×18



M3.5×12

G ×1

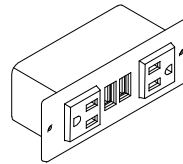

H ×26

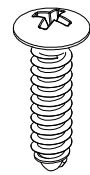

M4x12

J ×16

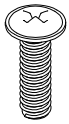

M4x14

K ×1

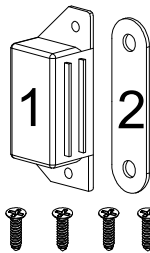

L ×12



M ×2

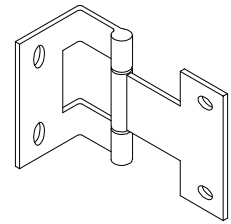

N ×2

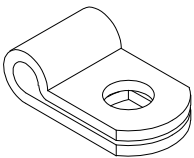

P ×14

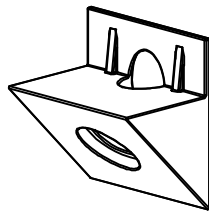

Q ×14

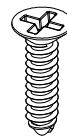

M3.5×14

R ×1

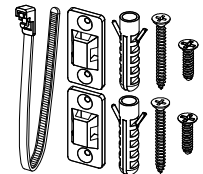

S ×2

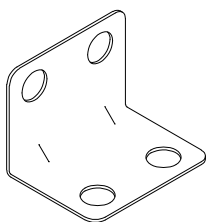

T ×8

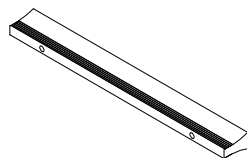

M96

×1

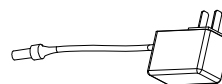

# STEP1

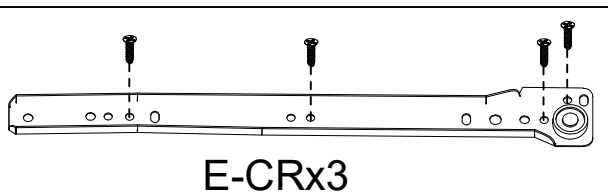
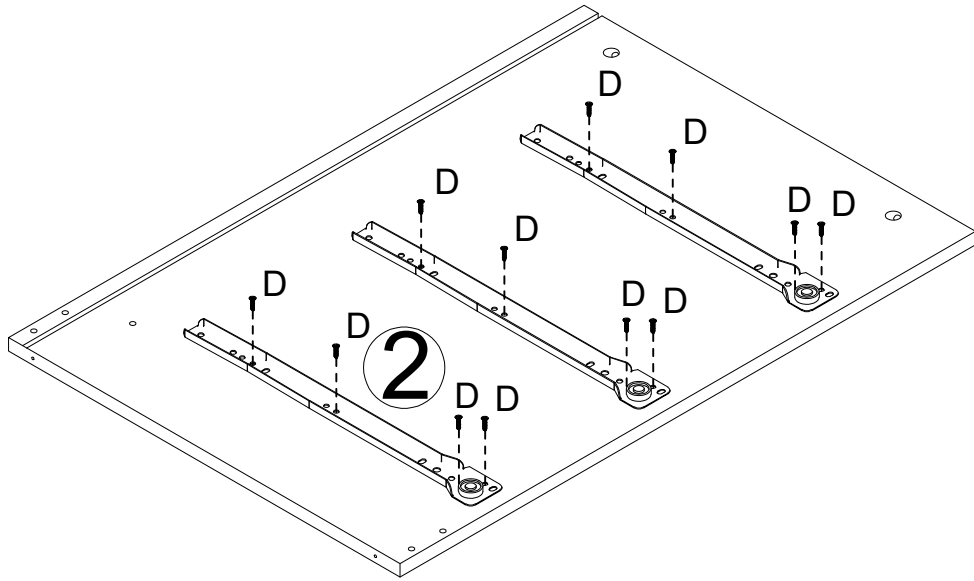
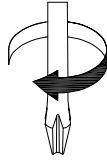

Dx12

# STEP2

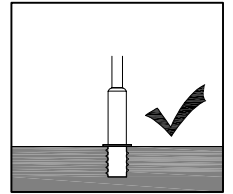
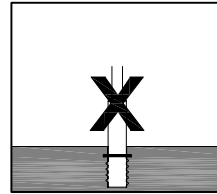
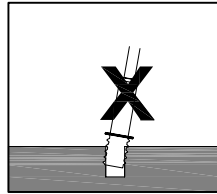
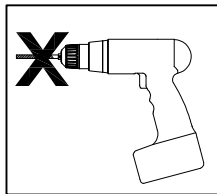

Iron Rod A is prohibited from using an electric drill.

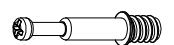
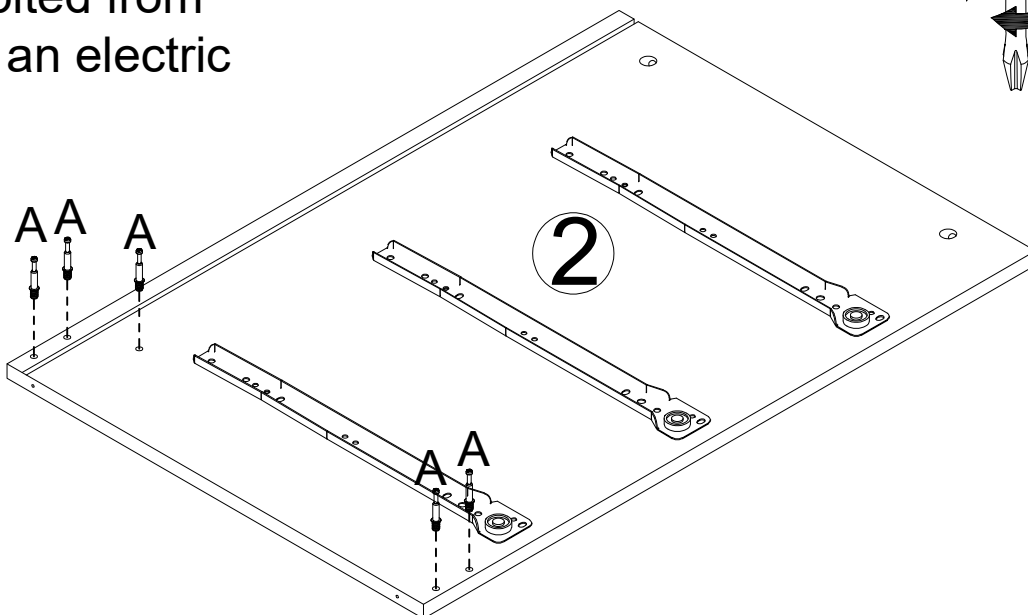
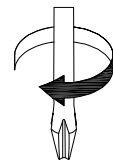

Ax5

# STEP3

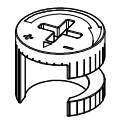
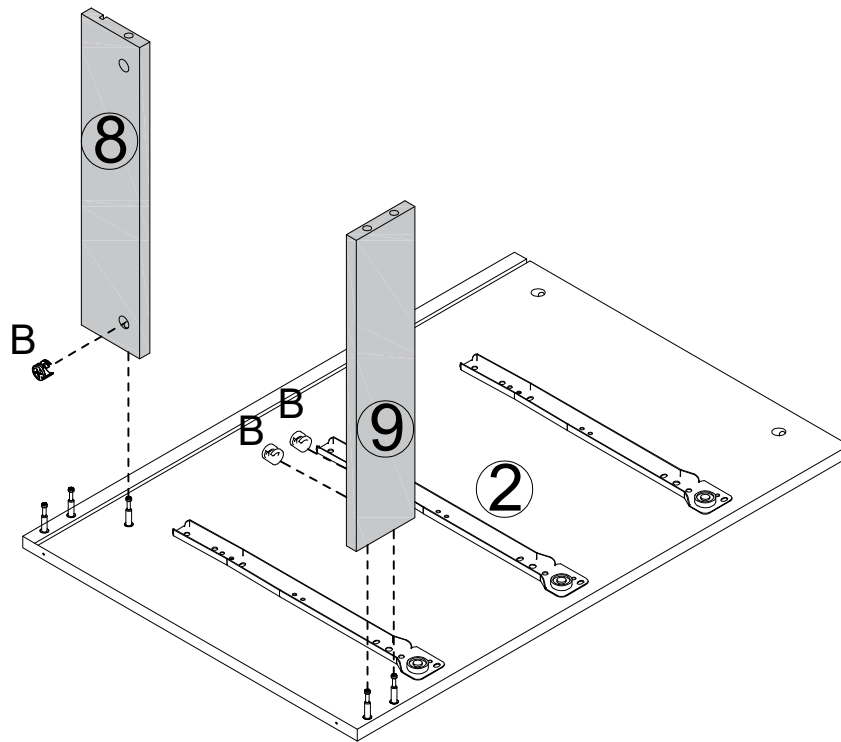
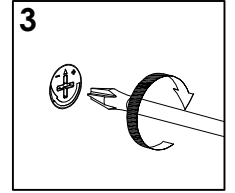
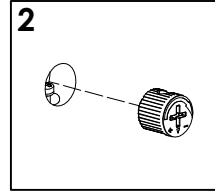
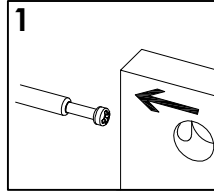
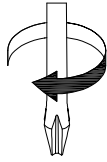

Bx3

# STEP4

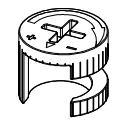
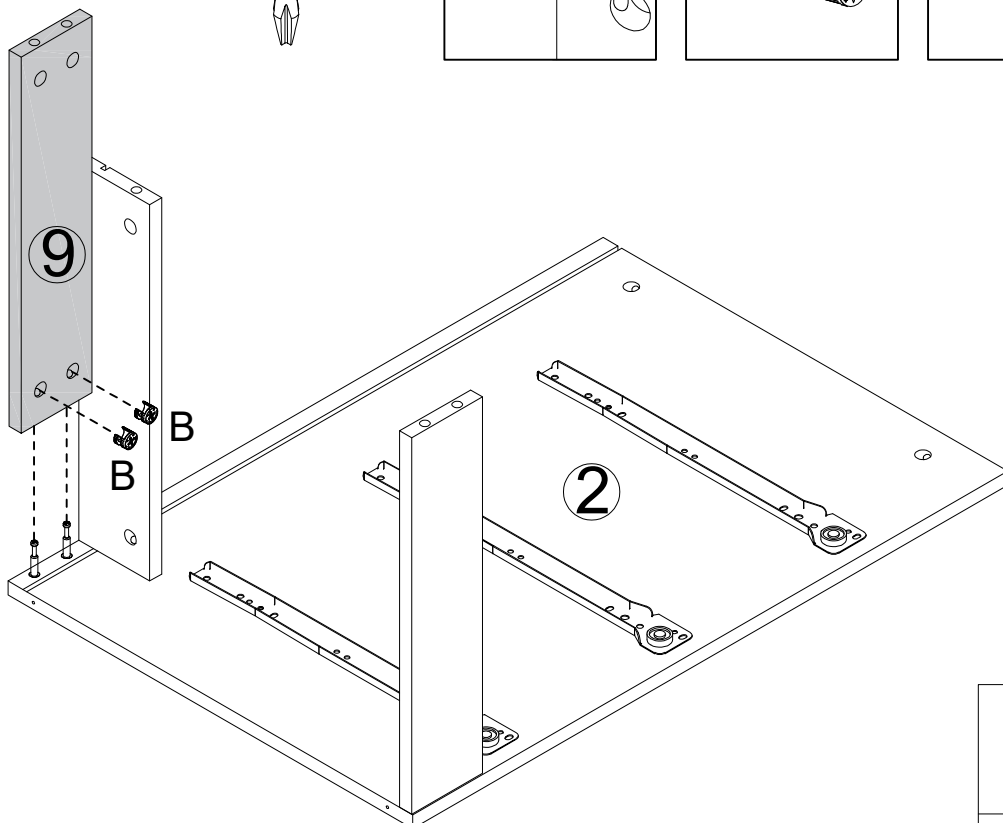
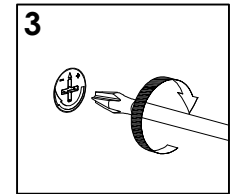
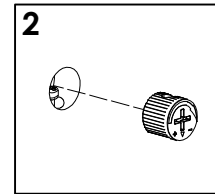
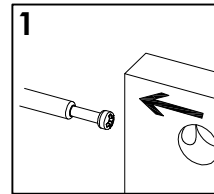
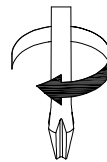

Bx2

# STEP5

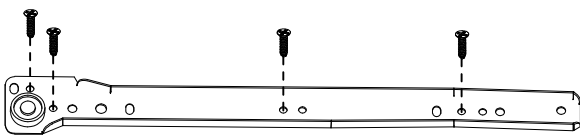
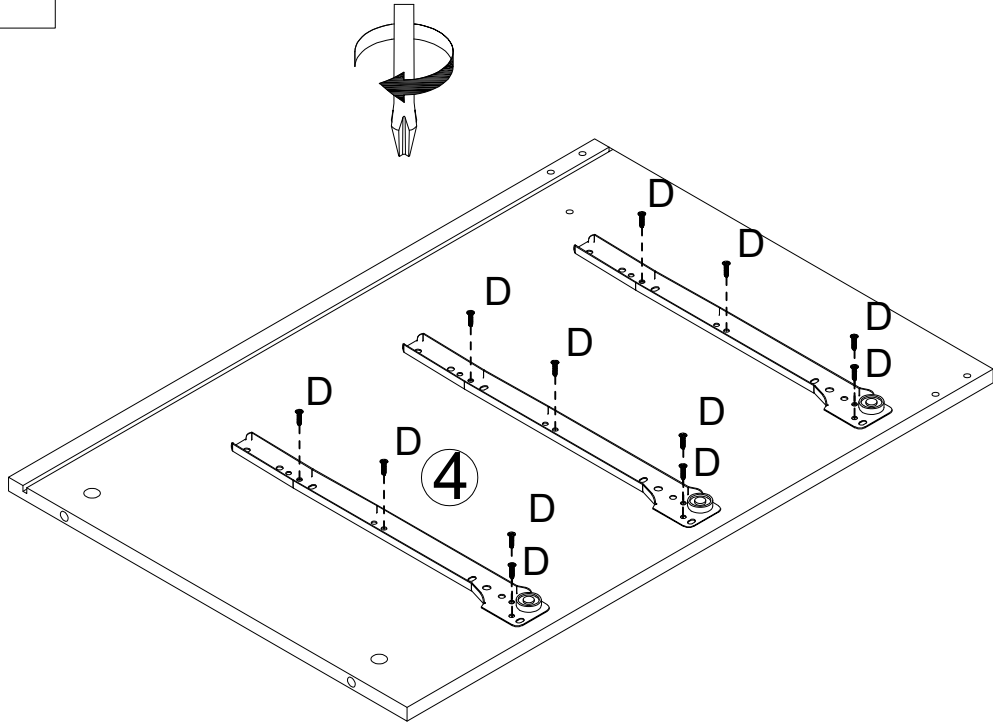

E-CLx3



Dx12

# STEP6

Iron Rod A is prohibited from using an electric drill.

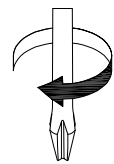
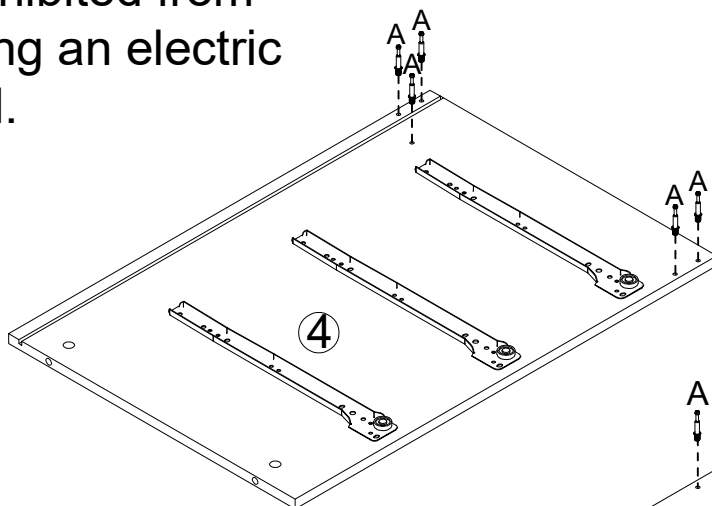
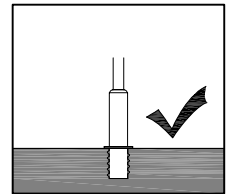
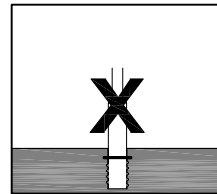
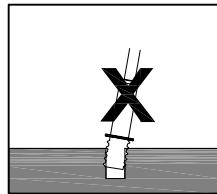
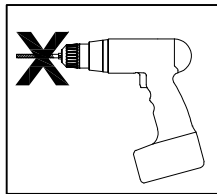

180°

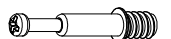
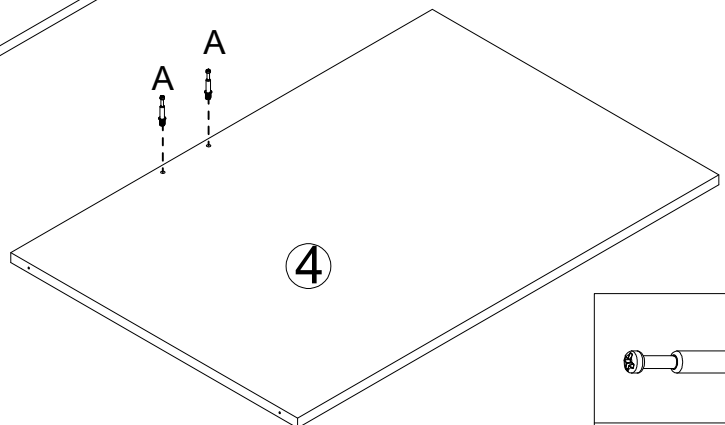

Ax7

# STEP 7

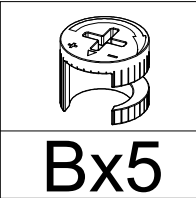
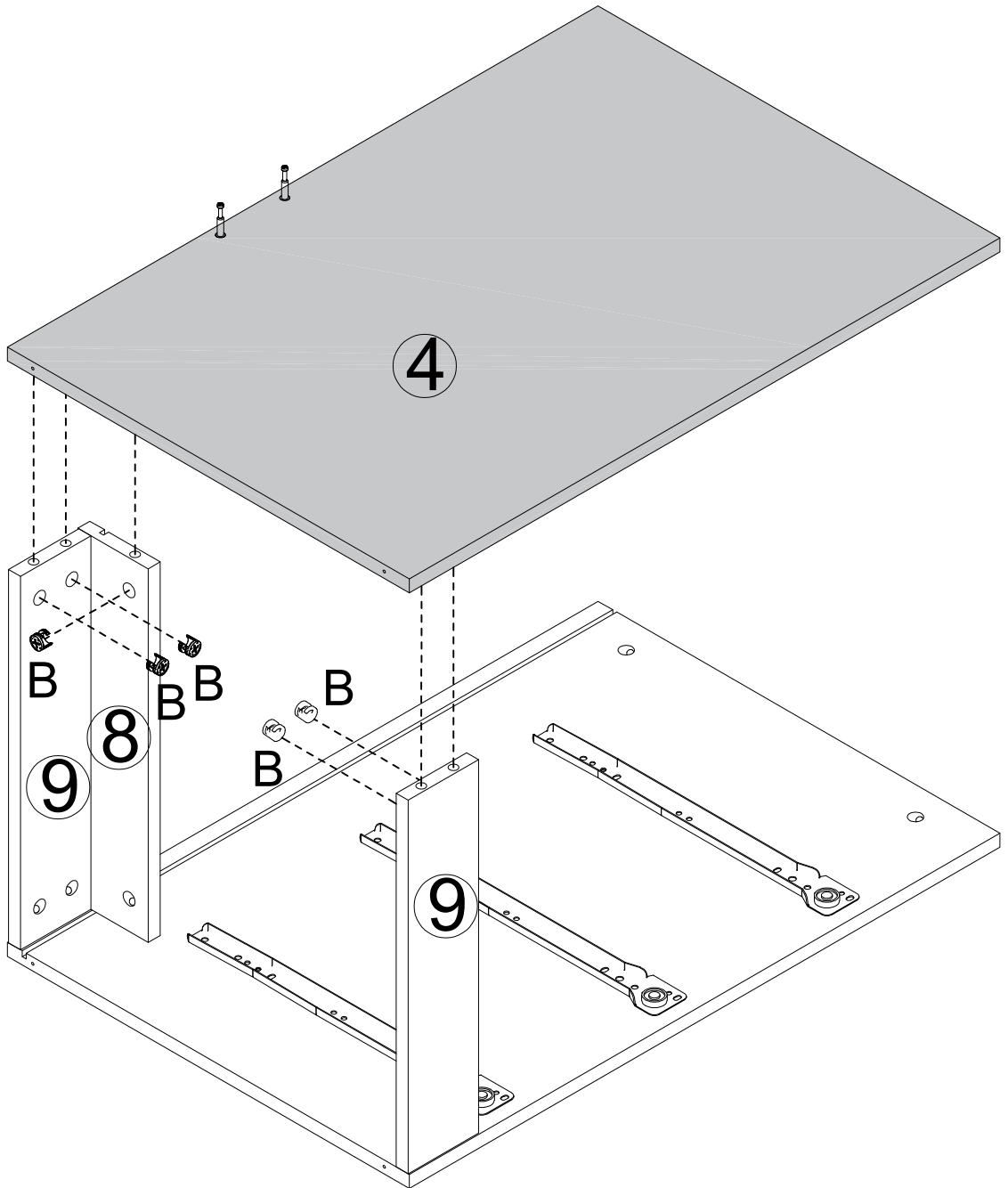
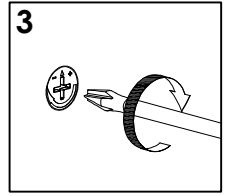
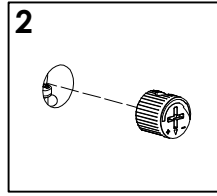
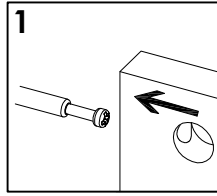
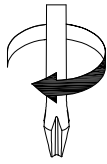

# STEP8

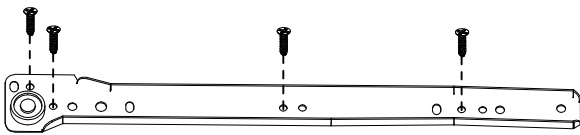
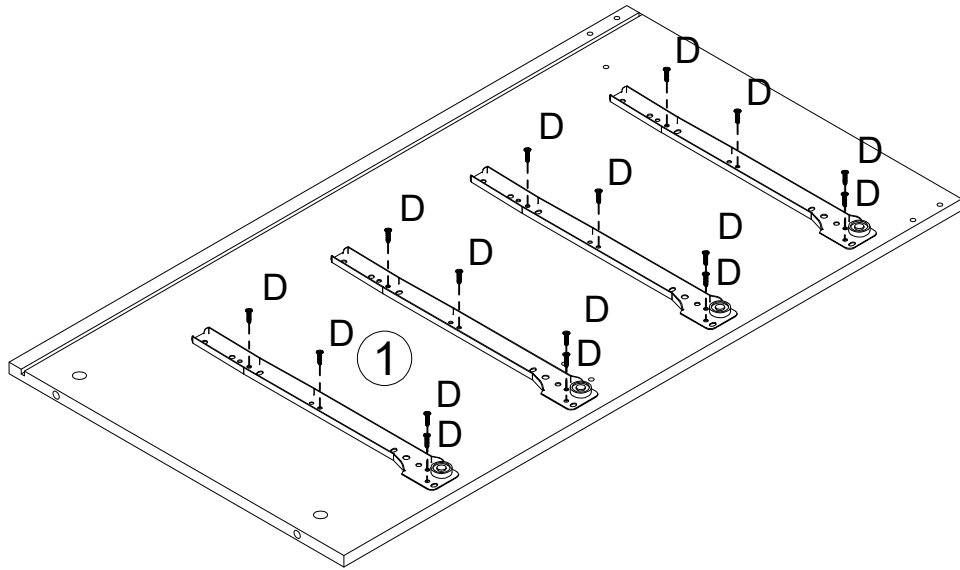
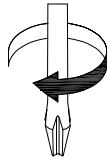

E-CLx4



Dx16

# STEP9

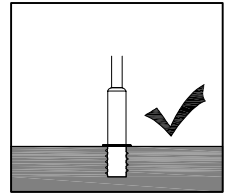
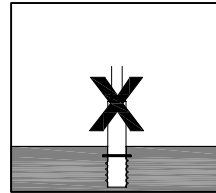
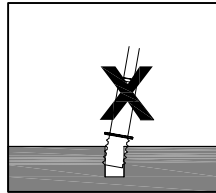
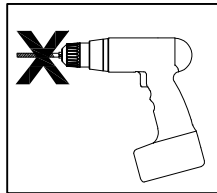

Iron Rod A is prohibited from using an electric drill.

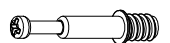
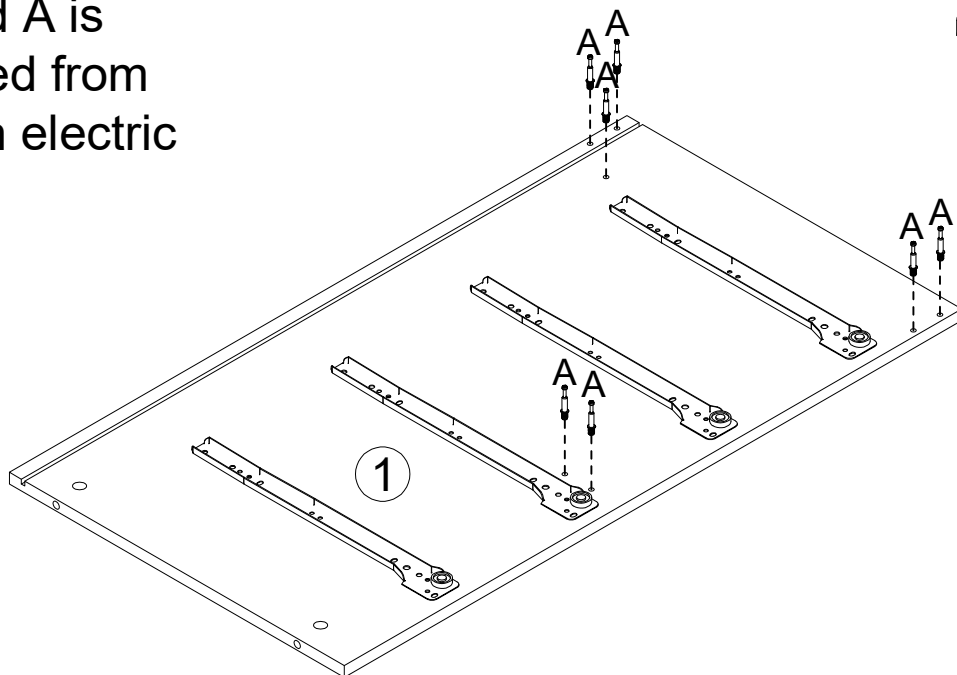
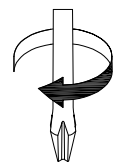

Ax7

# STEP10

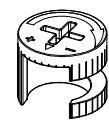
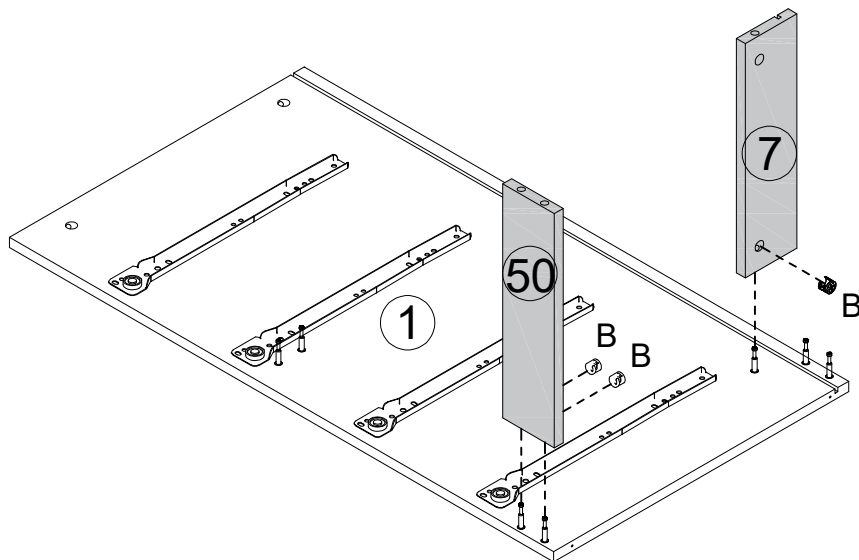
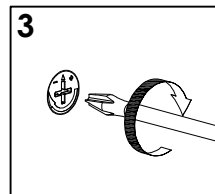
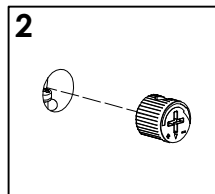
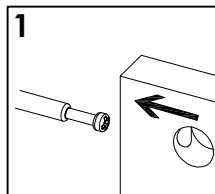
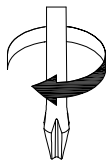

Bx3

# STEP11

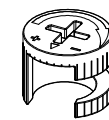
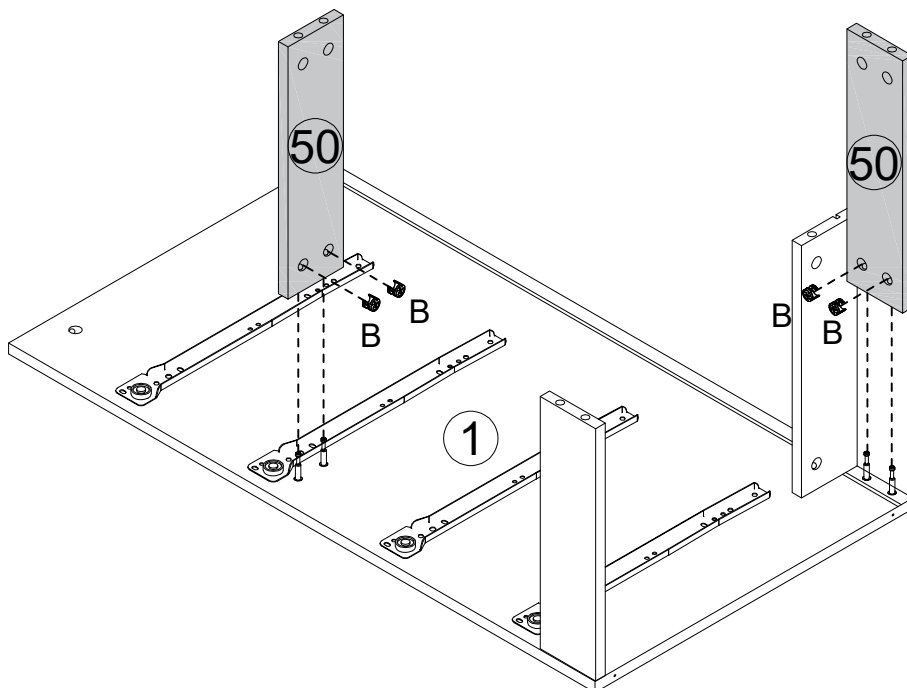
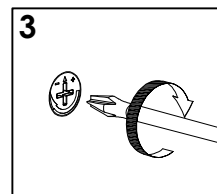
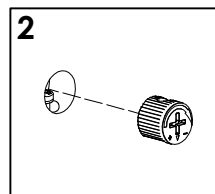
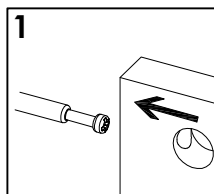
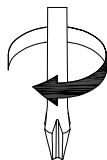

Bx4

# STEP 12

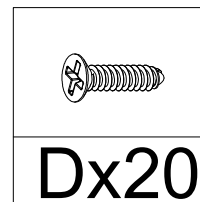
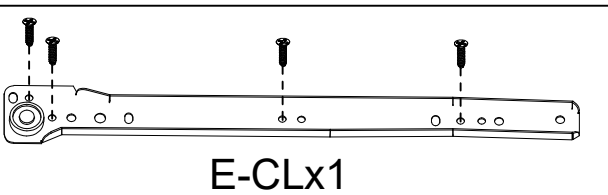
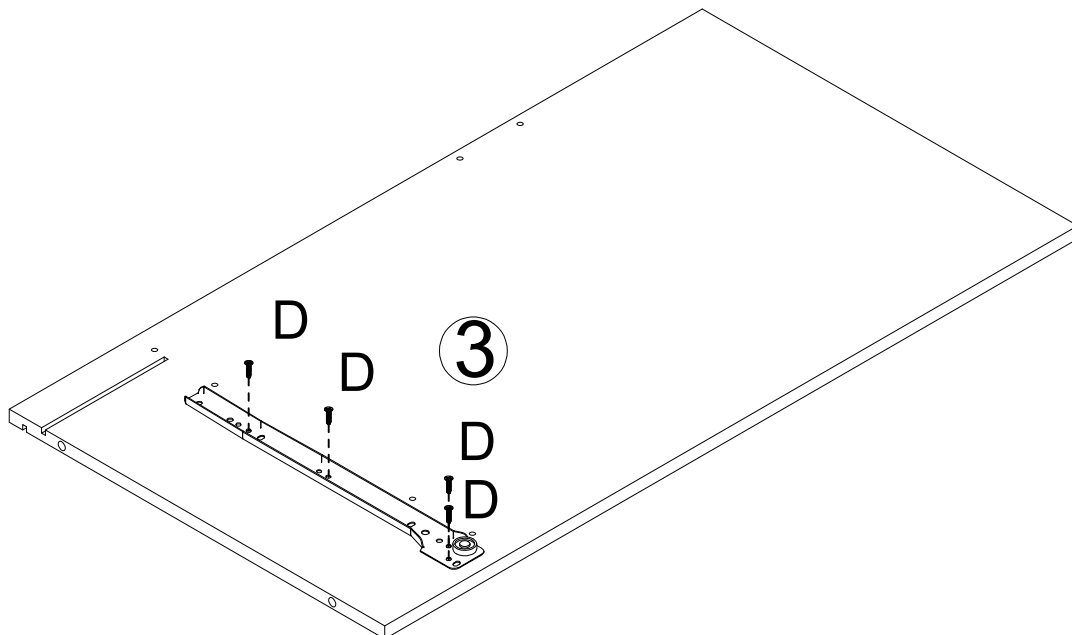
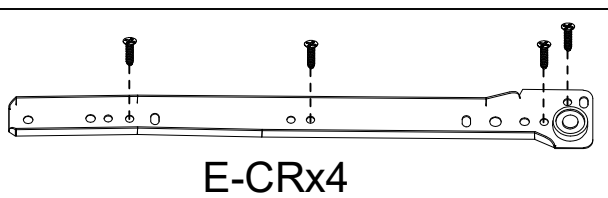
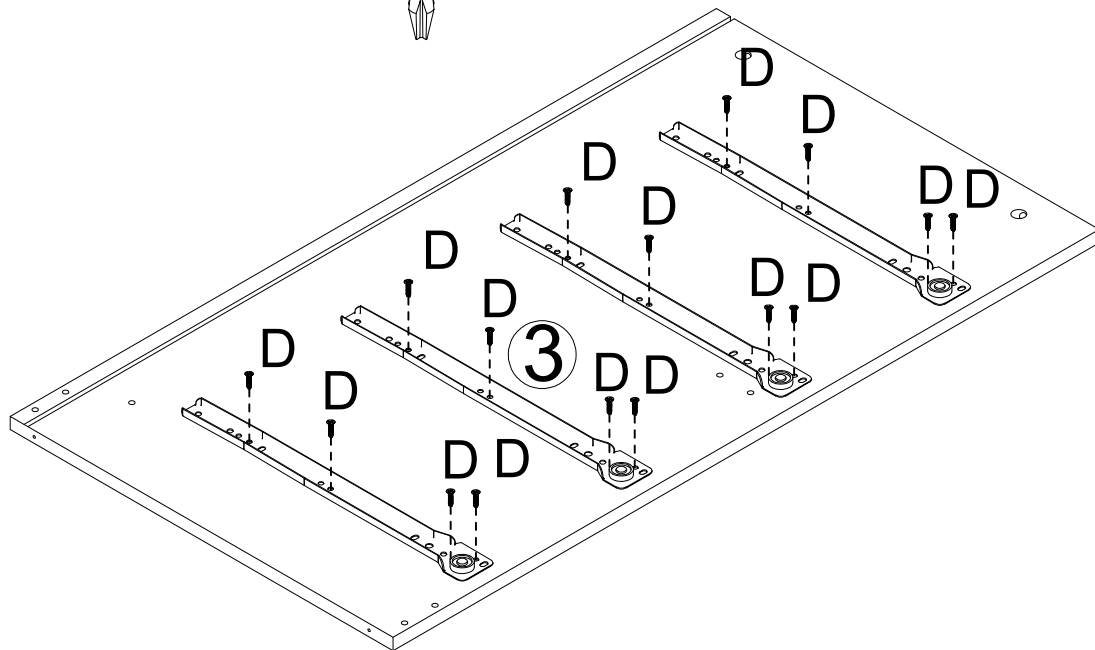
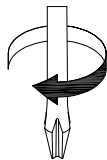

# STEP 13

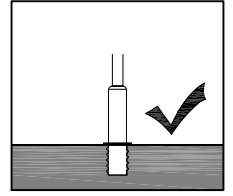
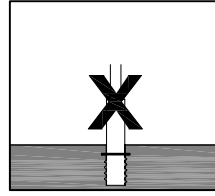
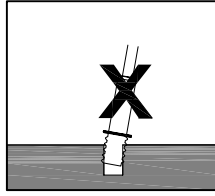
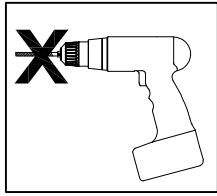

Iron Rod A is prohibited from using an electric drill.

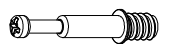
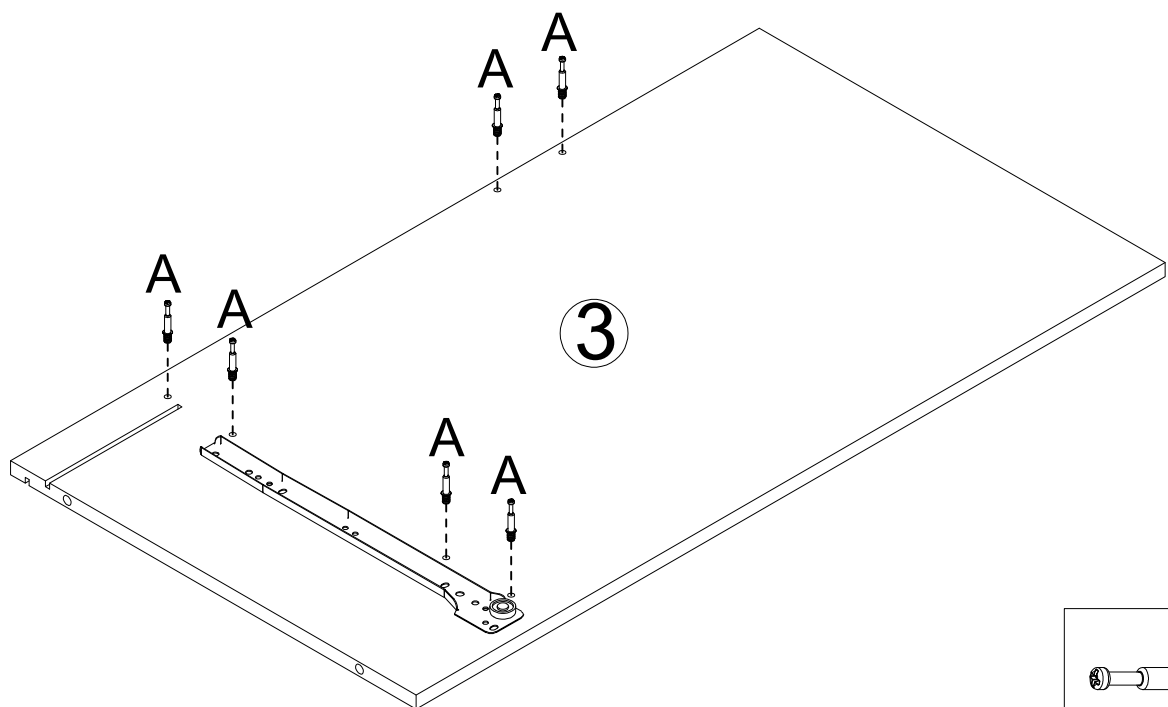
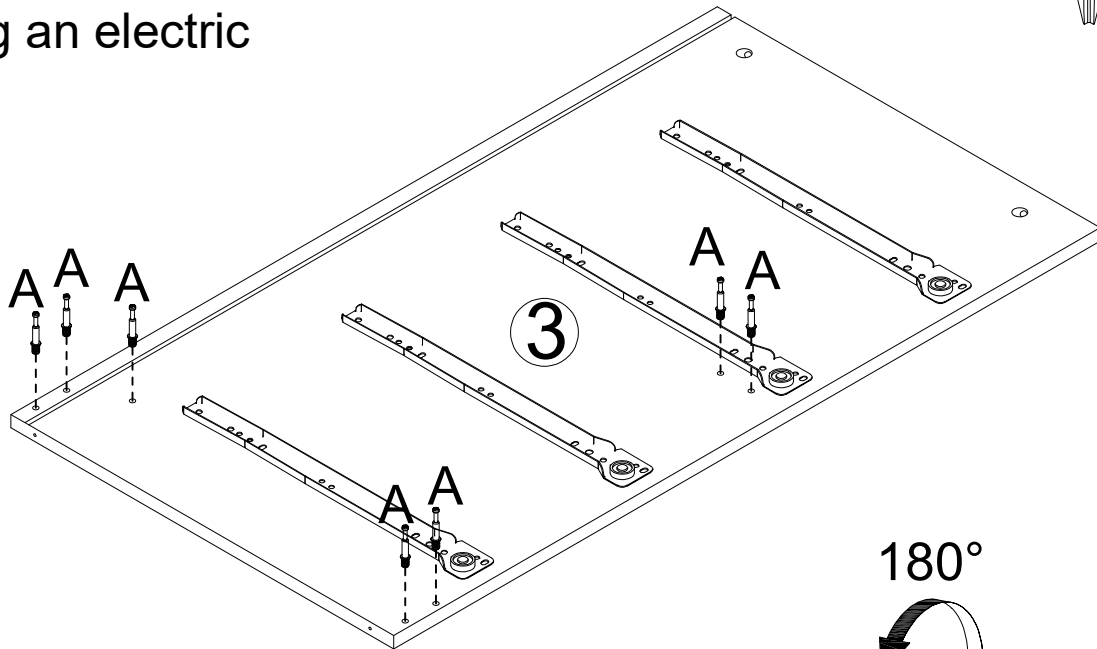
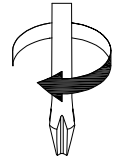

Ax13

# STEP14

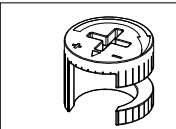
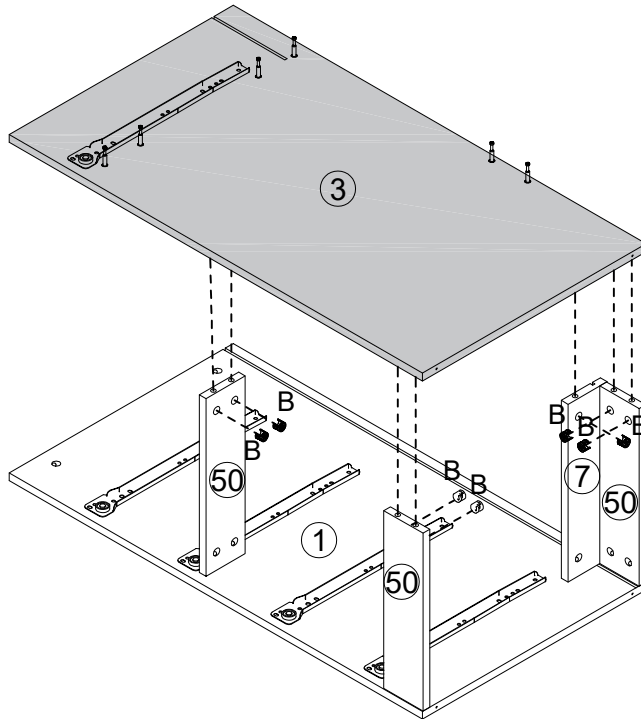
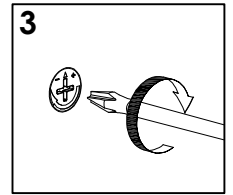
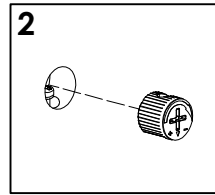
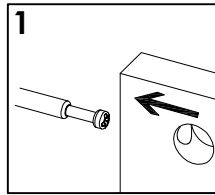
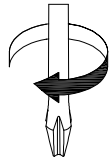

Bx7

# STEP15

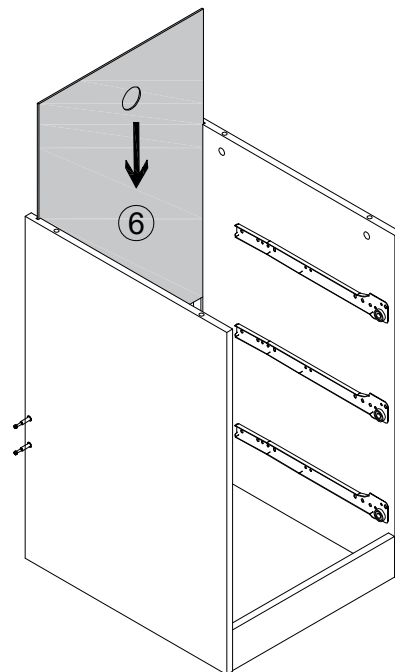
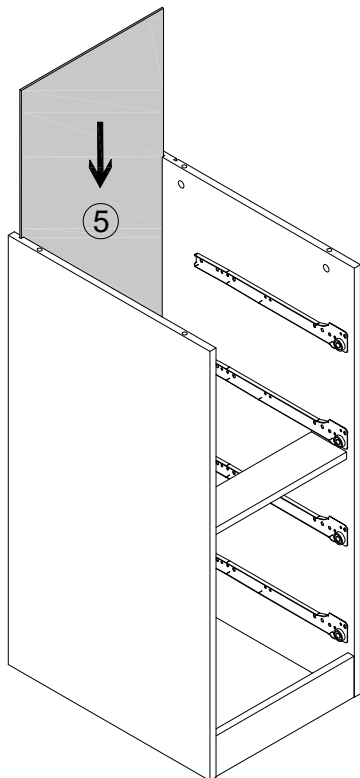

STEP 16

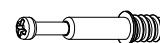
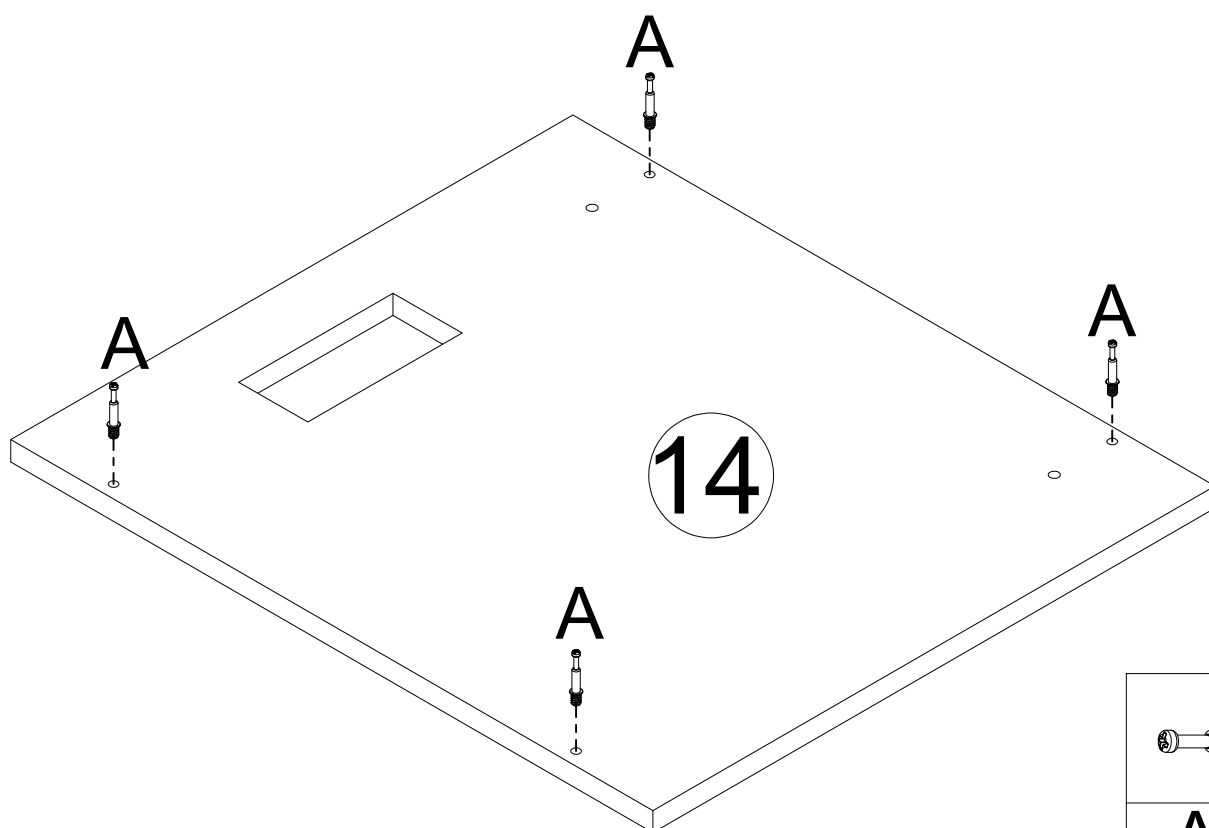
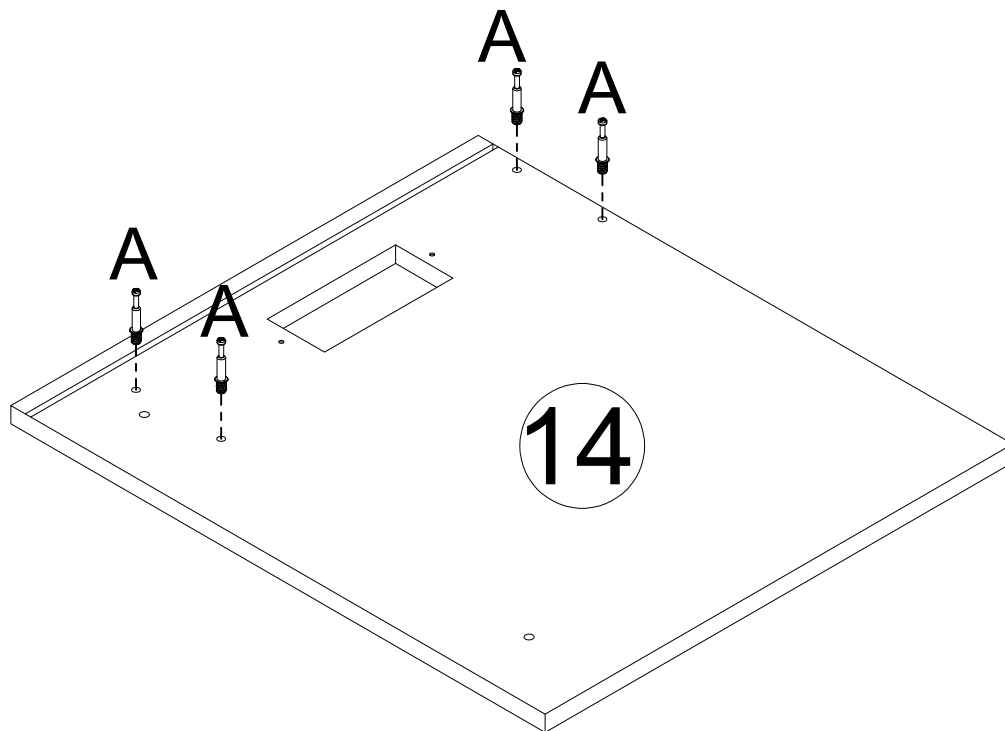
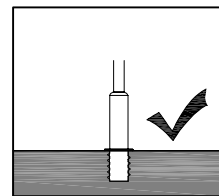
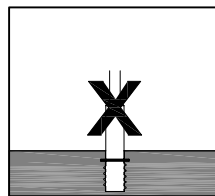
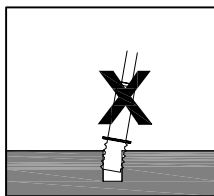
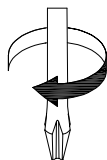

Ax8

# STEP17

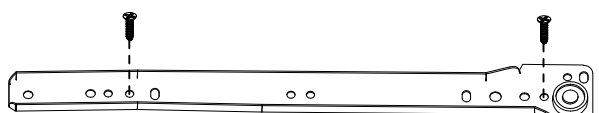
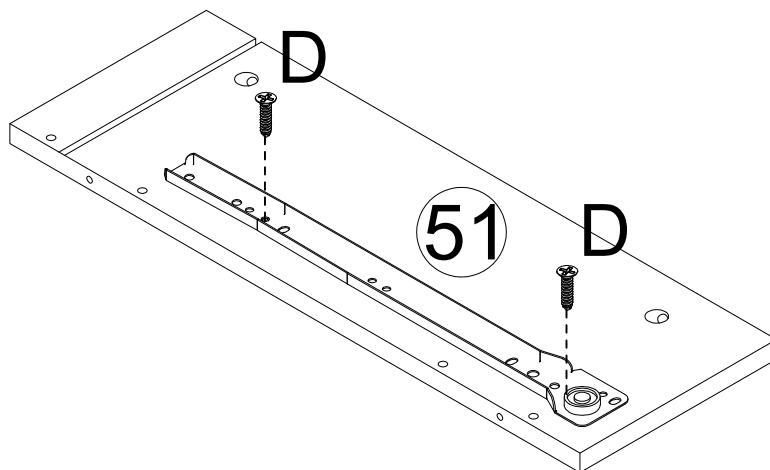
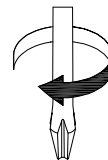

E-CRx1



Dx2

# STEP18

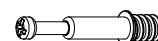
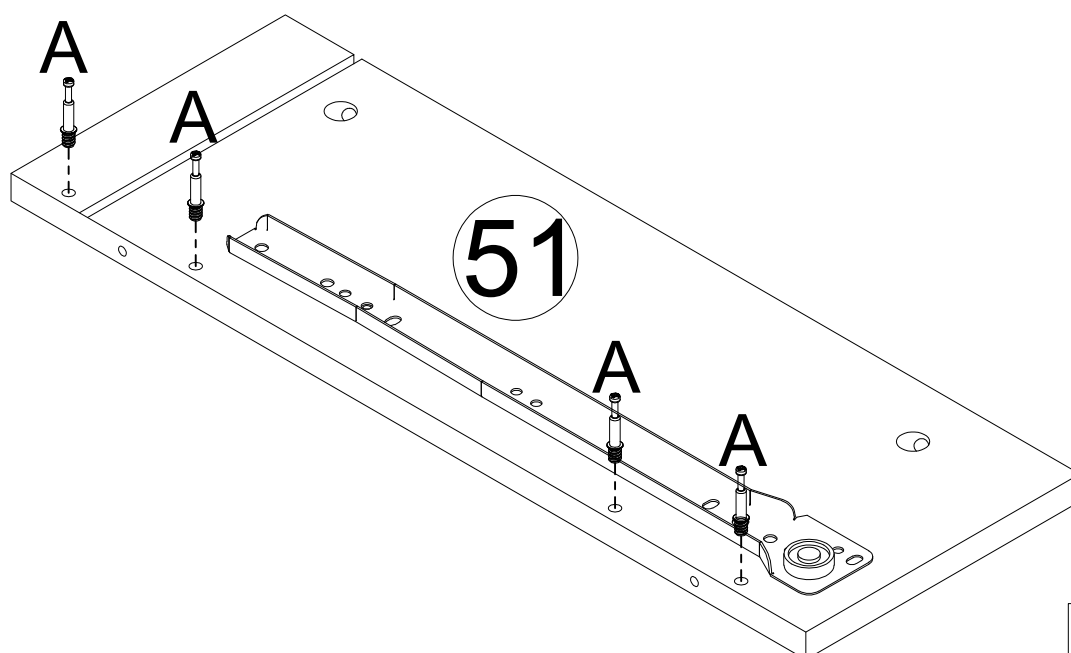
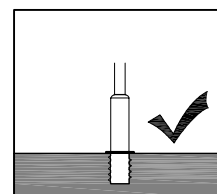
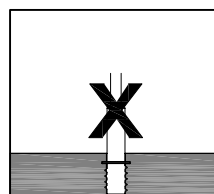
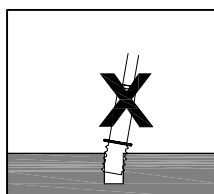
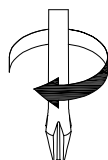

Ax4

# STEP19

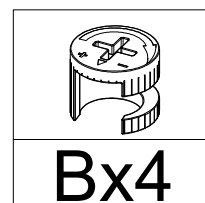
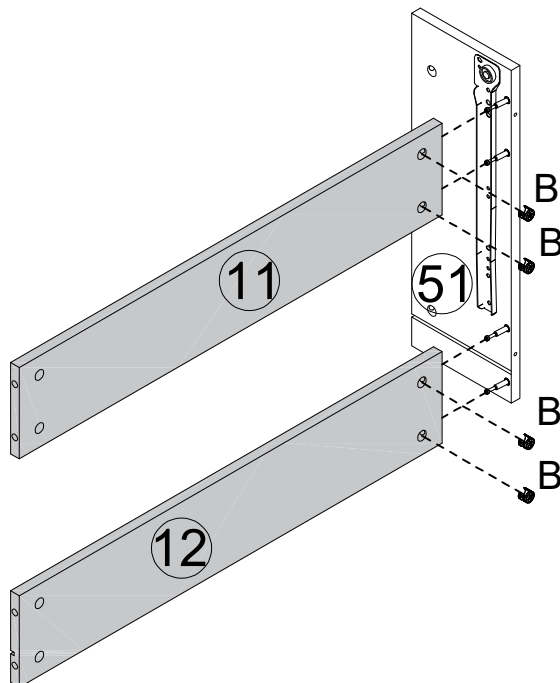
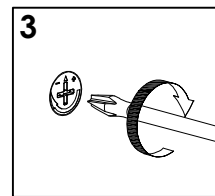
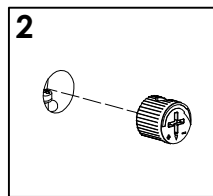
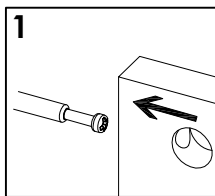
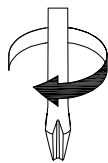

# STEP20

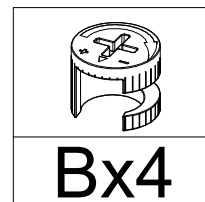
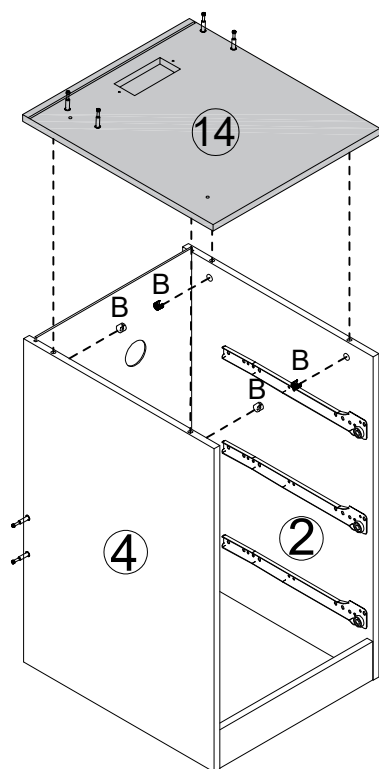
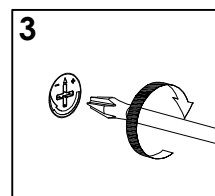
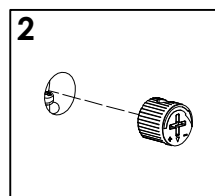
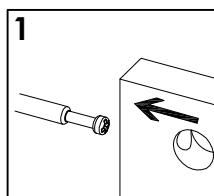
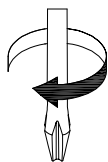

# STEP21

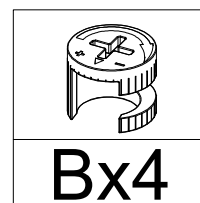
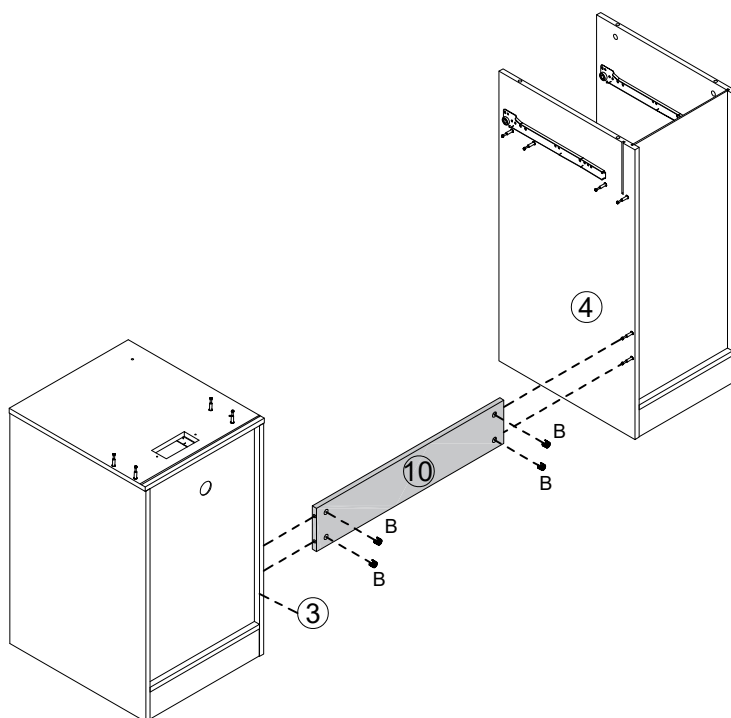
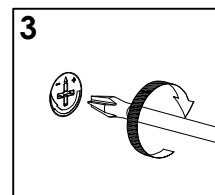
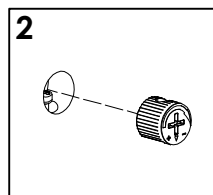
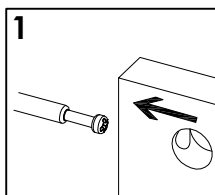
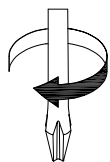

**Bx4**

# STEP22

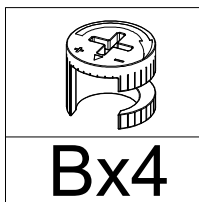
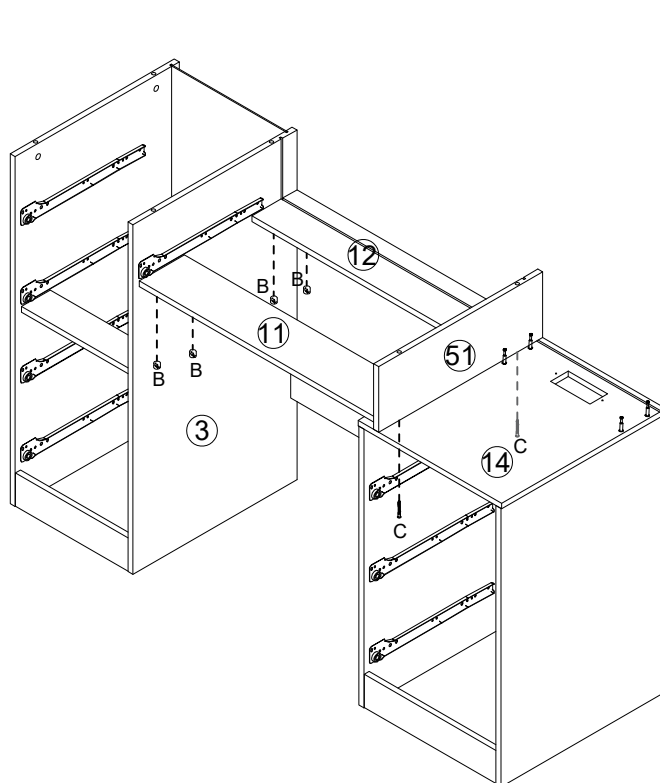
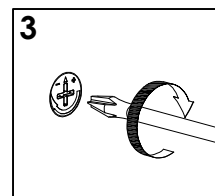
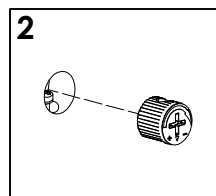
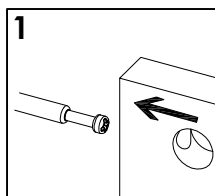
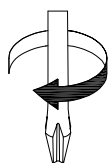

**Bx4**



**Cx2**

# STEP23

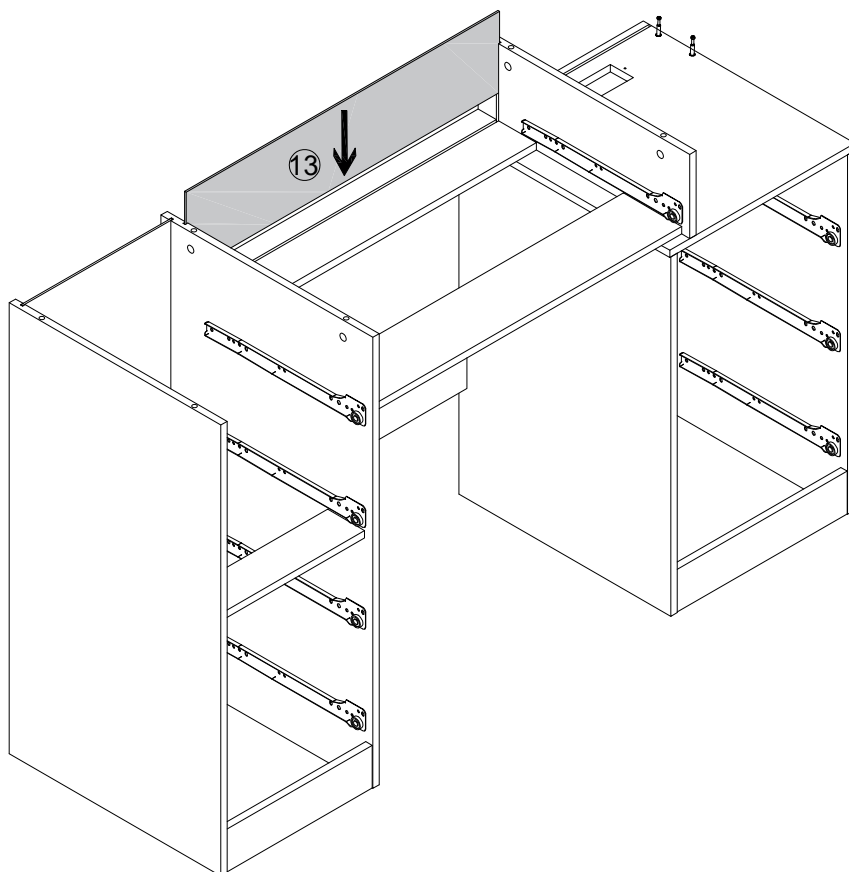

# STEP24

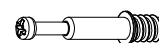
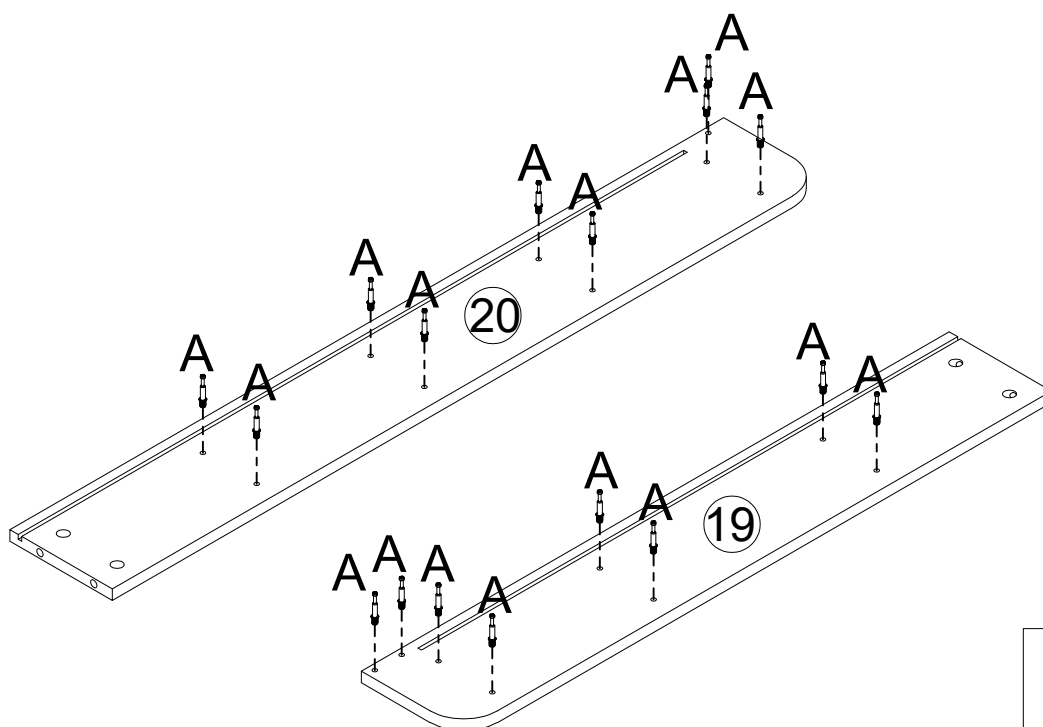
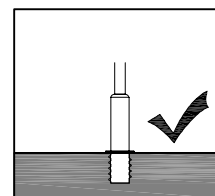
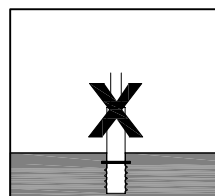
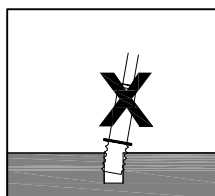
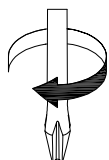

Ax17

# STEP25

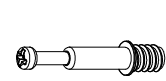
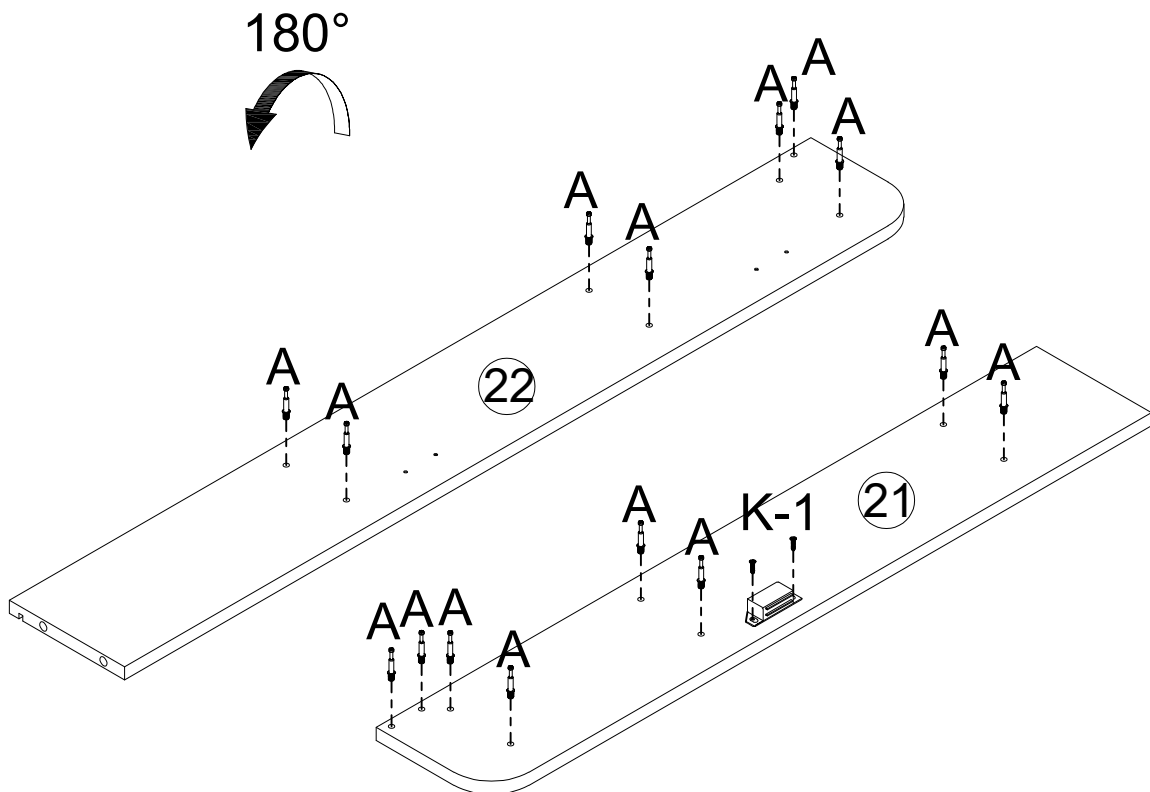
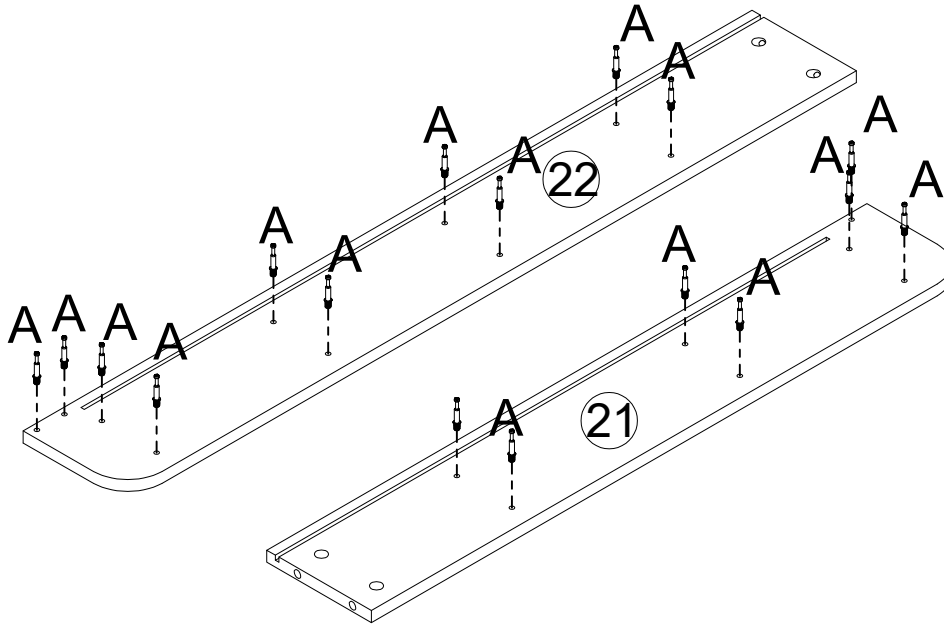
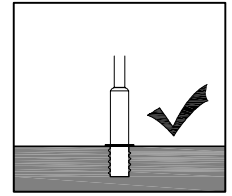
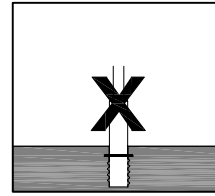
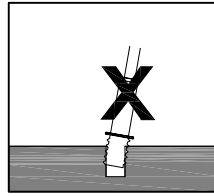
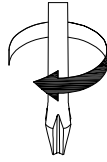

Ax32

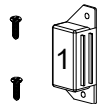

K-1x1

# STEP26

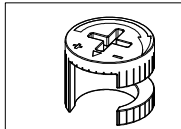
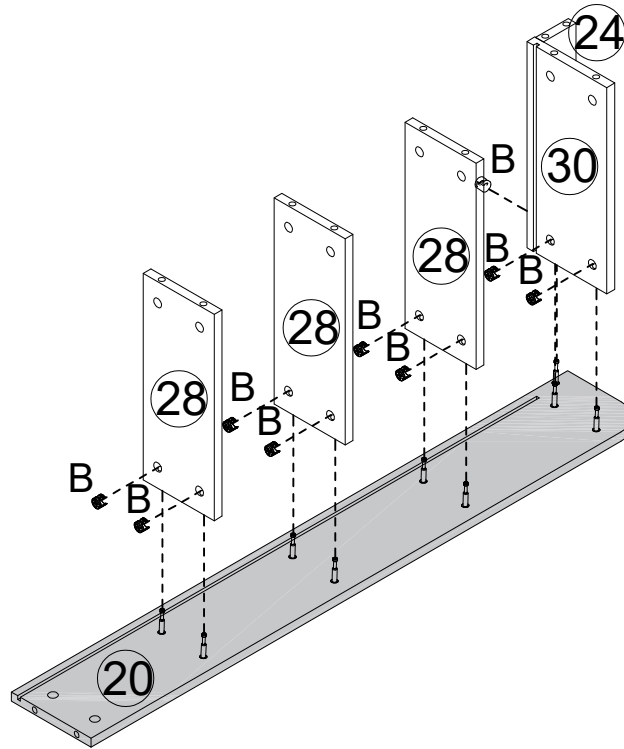
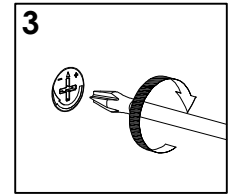
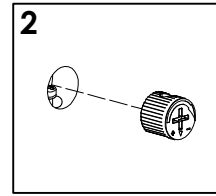
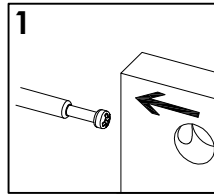
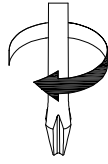

Bx9

# STEP27

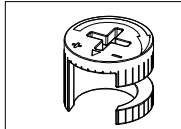
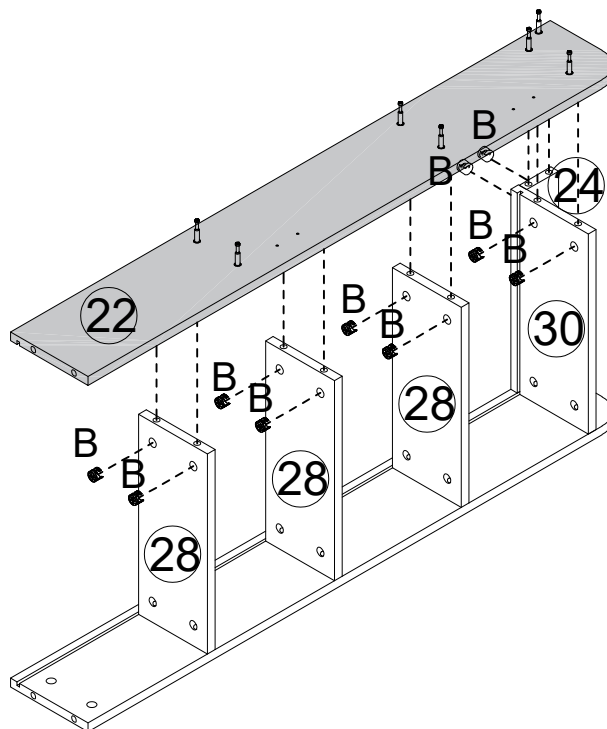
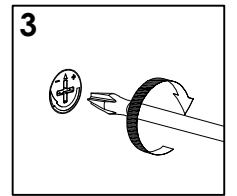
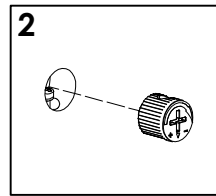
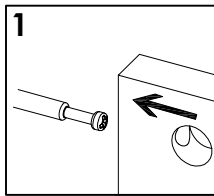
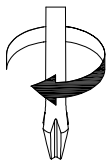

Bx10

# STEP28

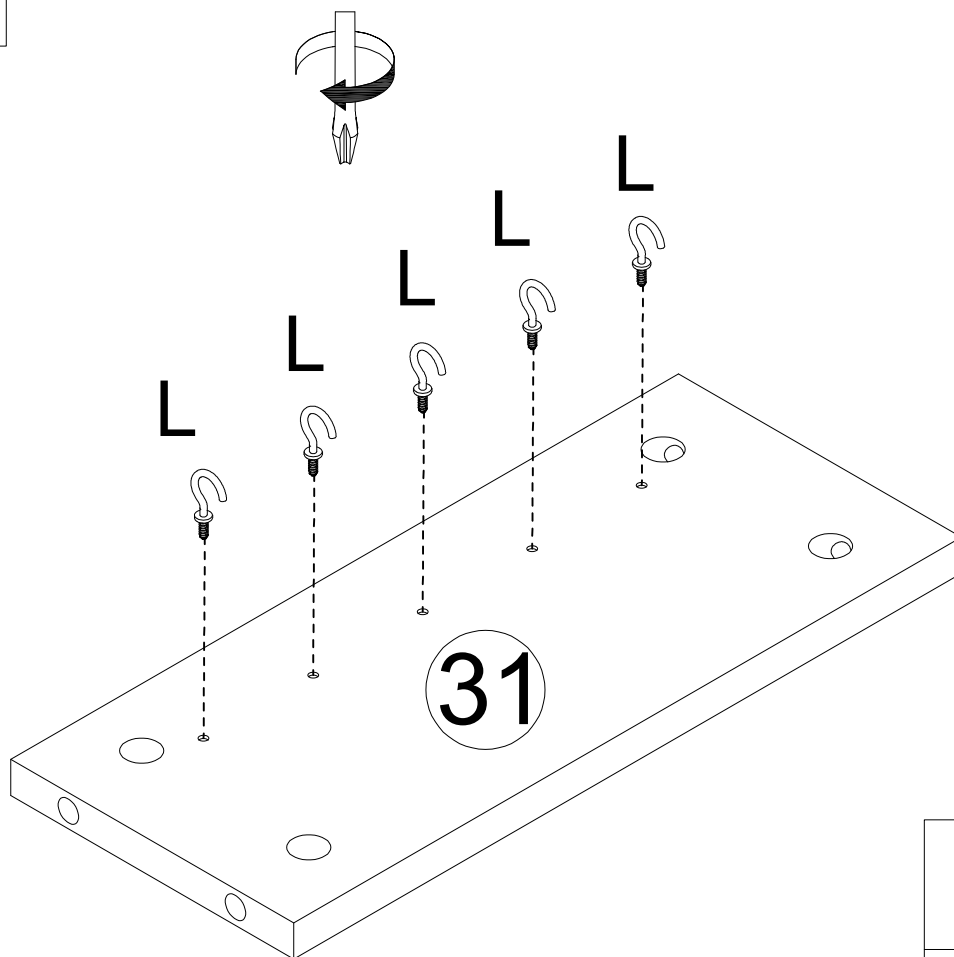

Lx5

# STEP29

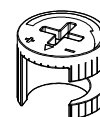
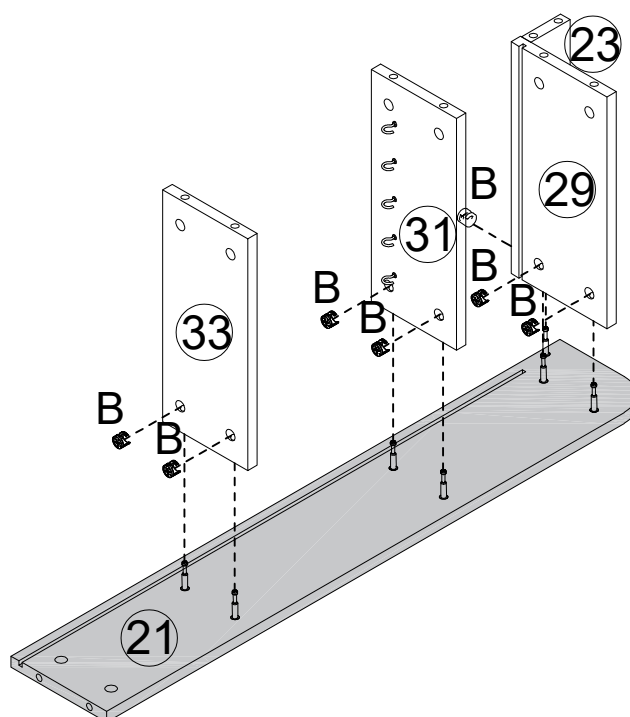
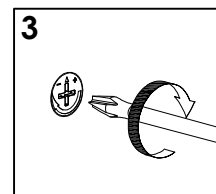
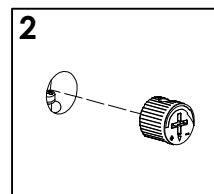
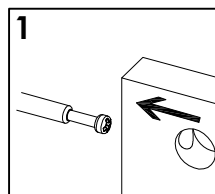
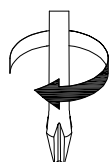

Bx7

# STEP30

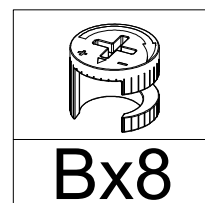
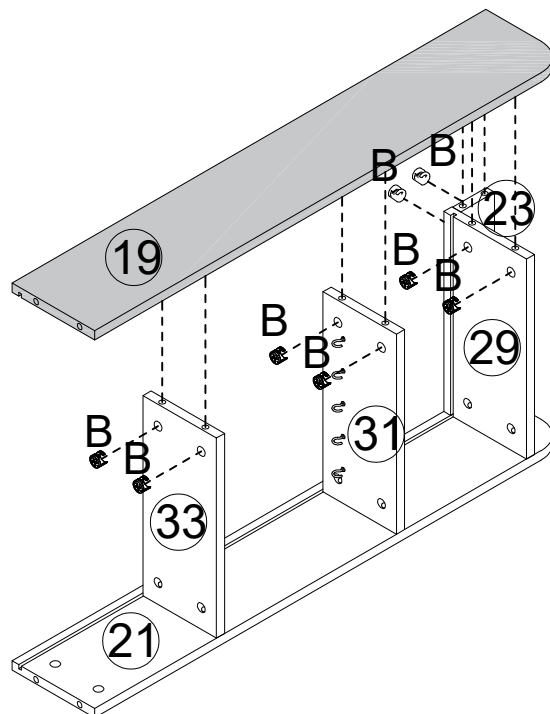
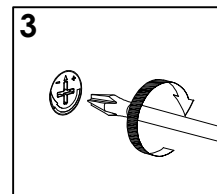
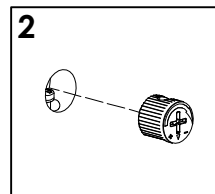
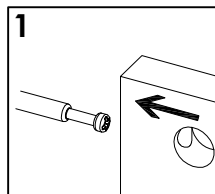
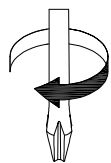

# STEP31

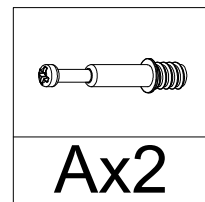
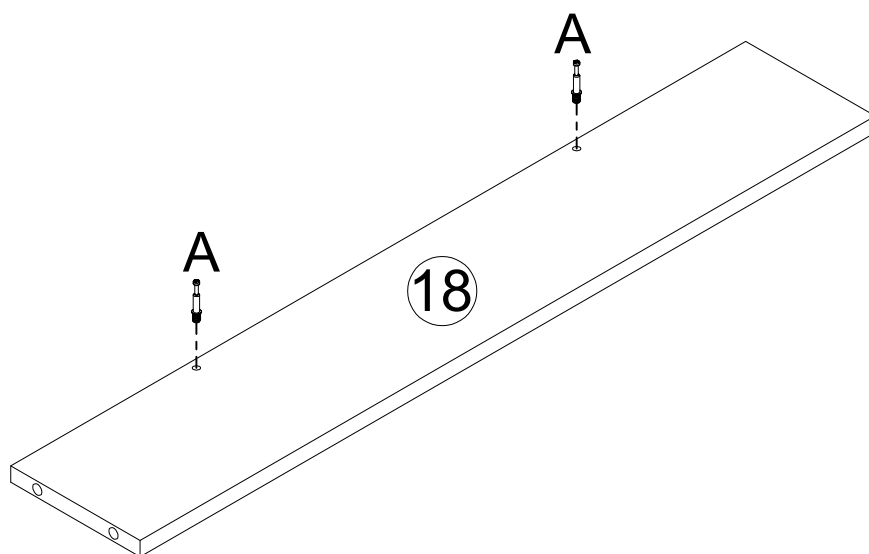
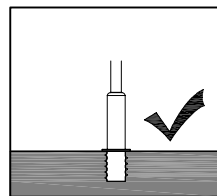
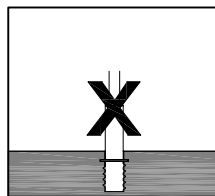
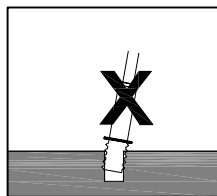
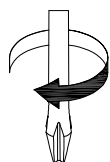

# STEP32

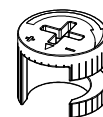
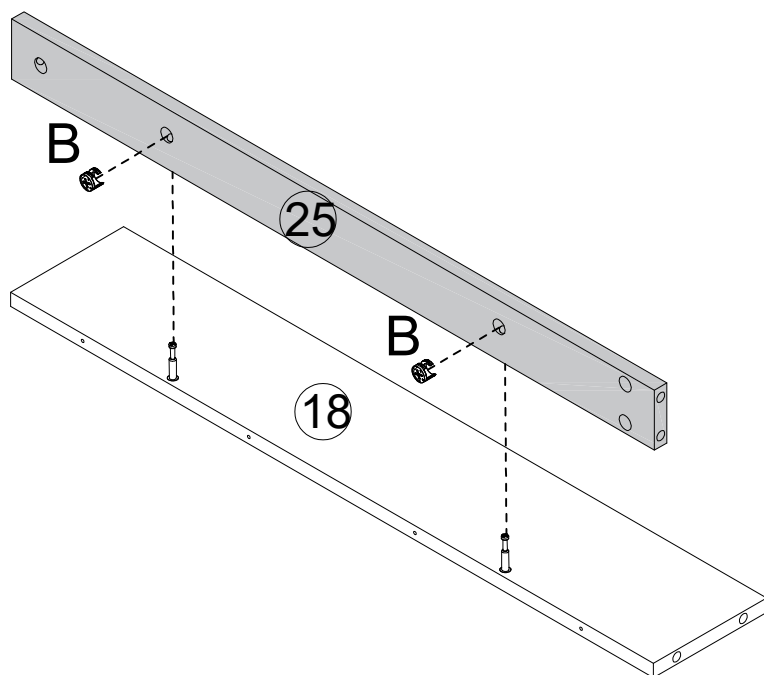
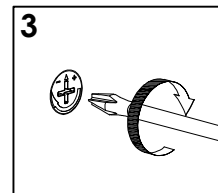
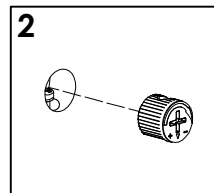
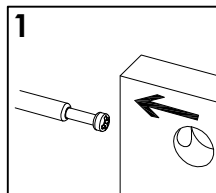
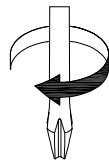

Bx2

# STEP33

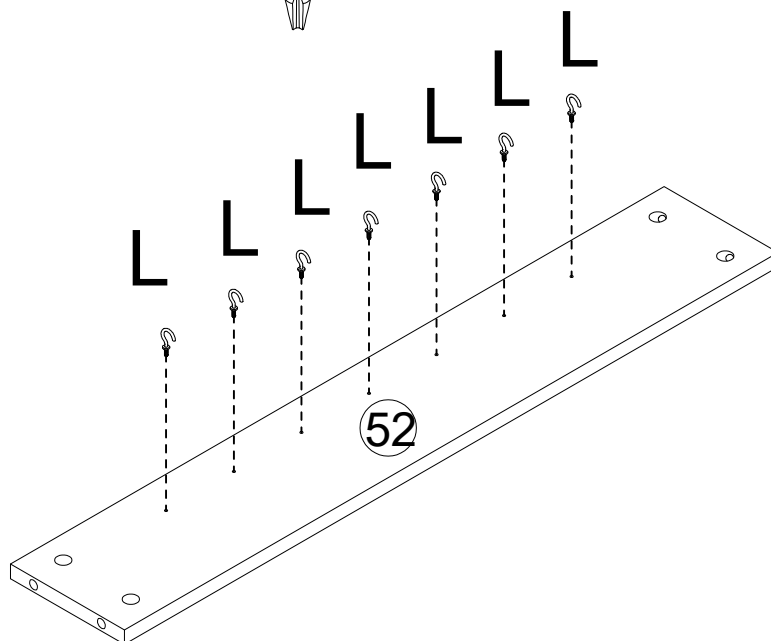
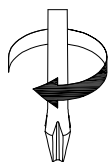

Lx7

# STEP34

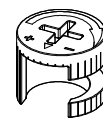
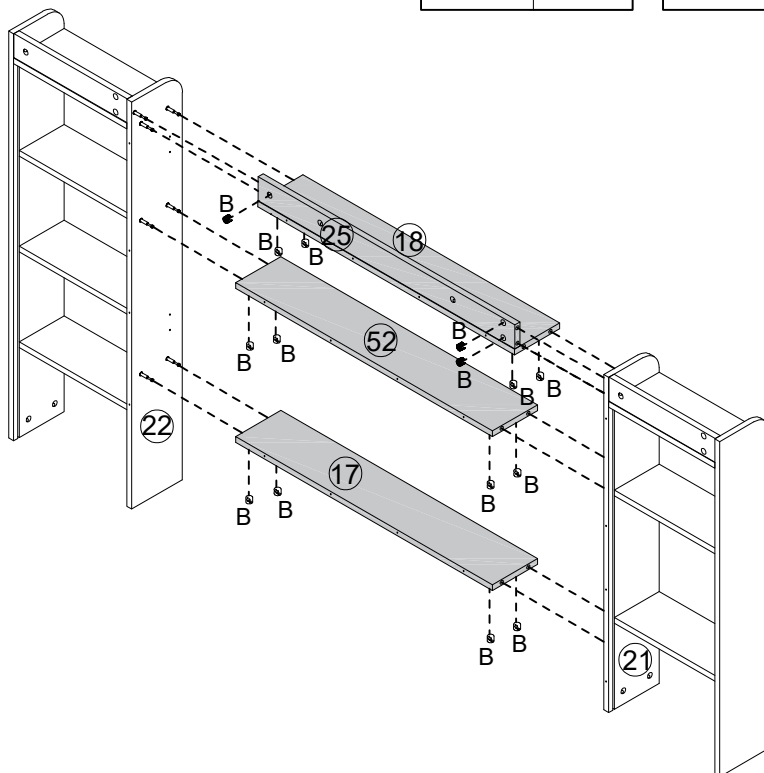
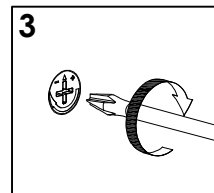
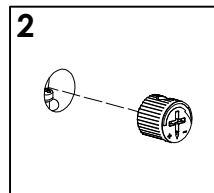
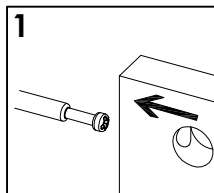
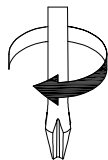

Bx15

# STEP35

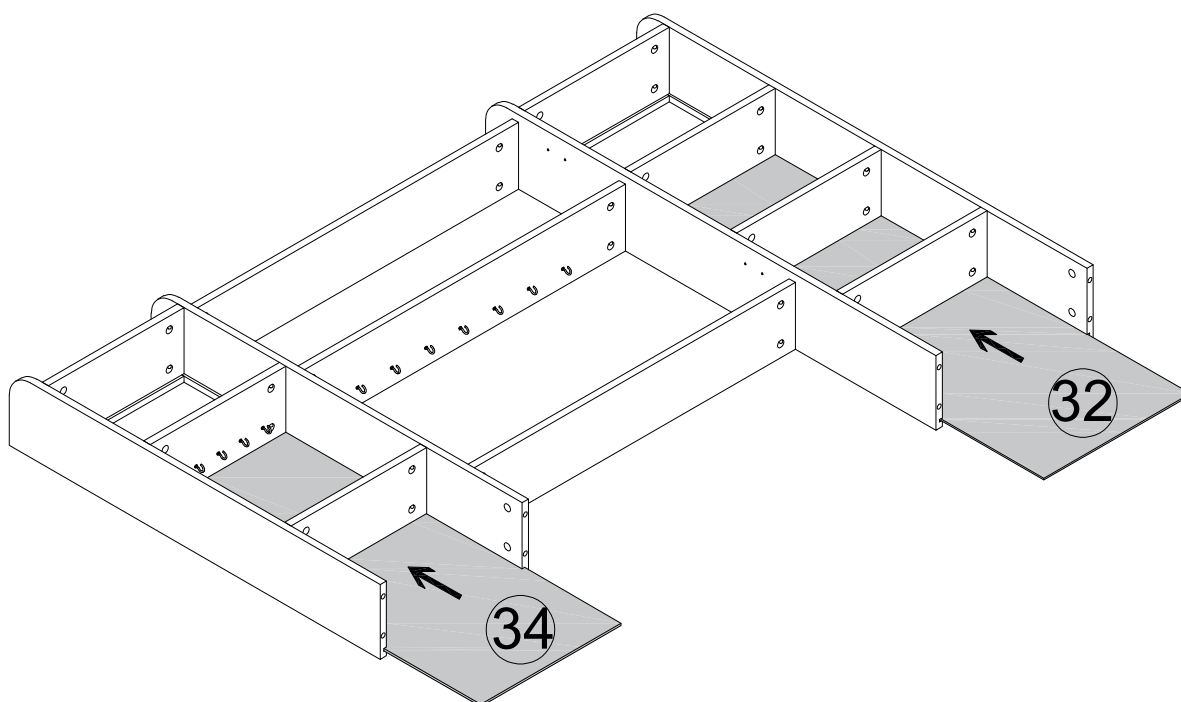

# STEP36

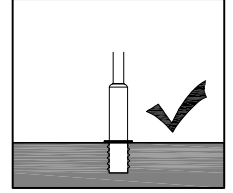
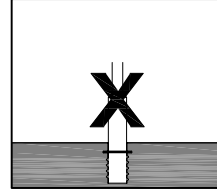
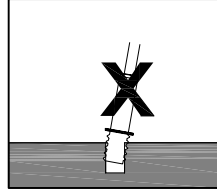
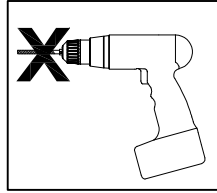

Iron Rod A is prohibited from using an electric drill.

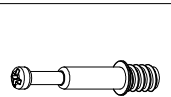
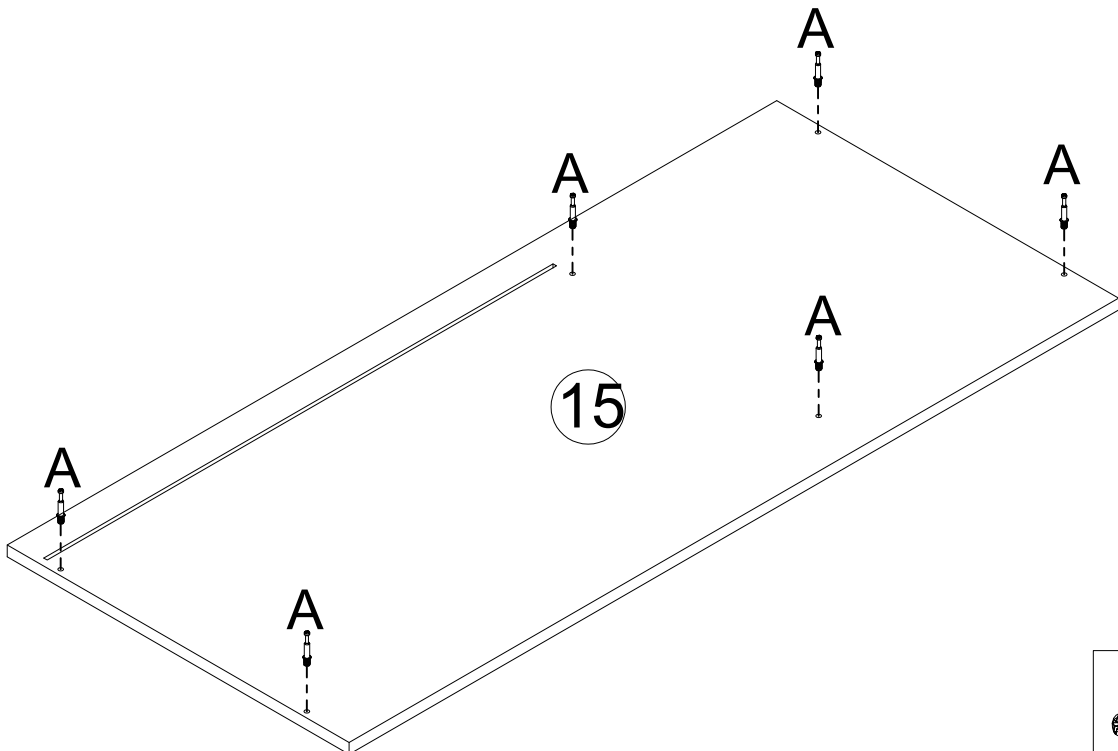
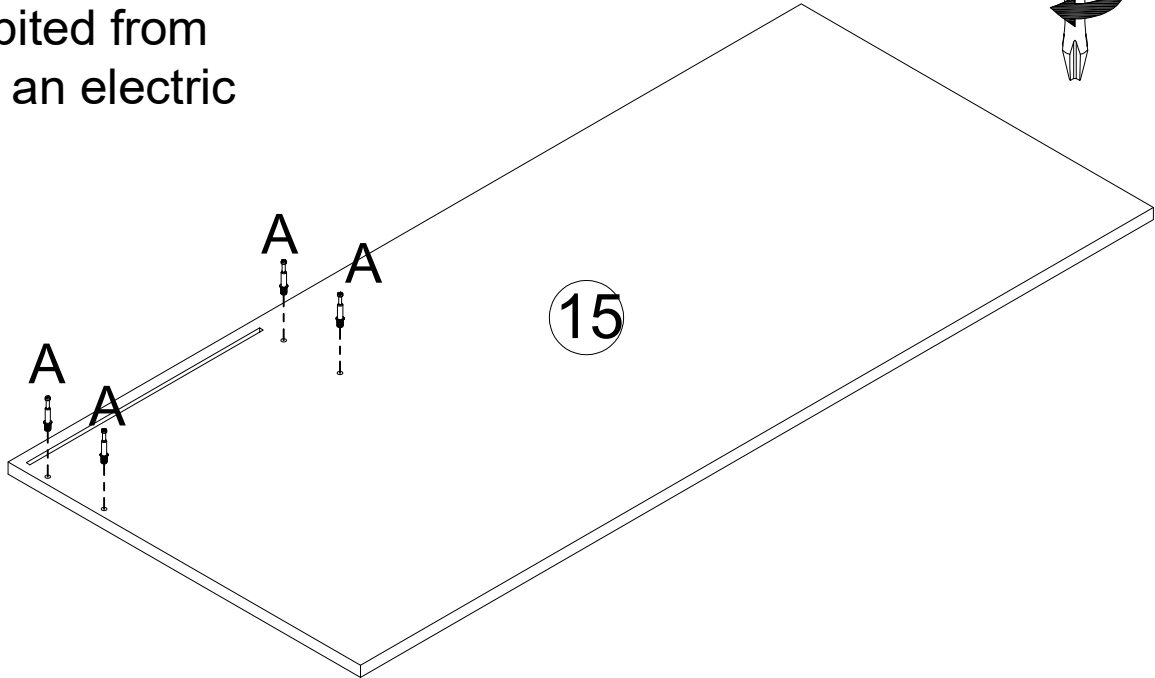
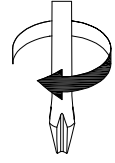

Ax10

# STEP37

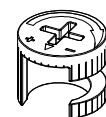
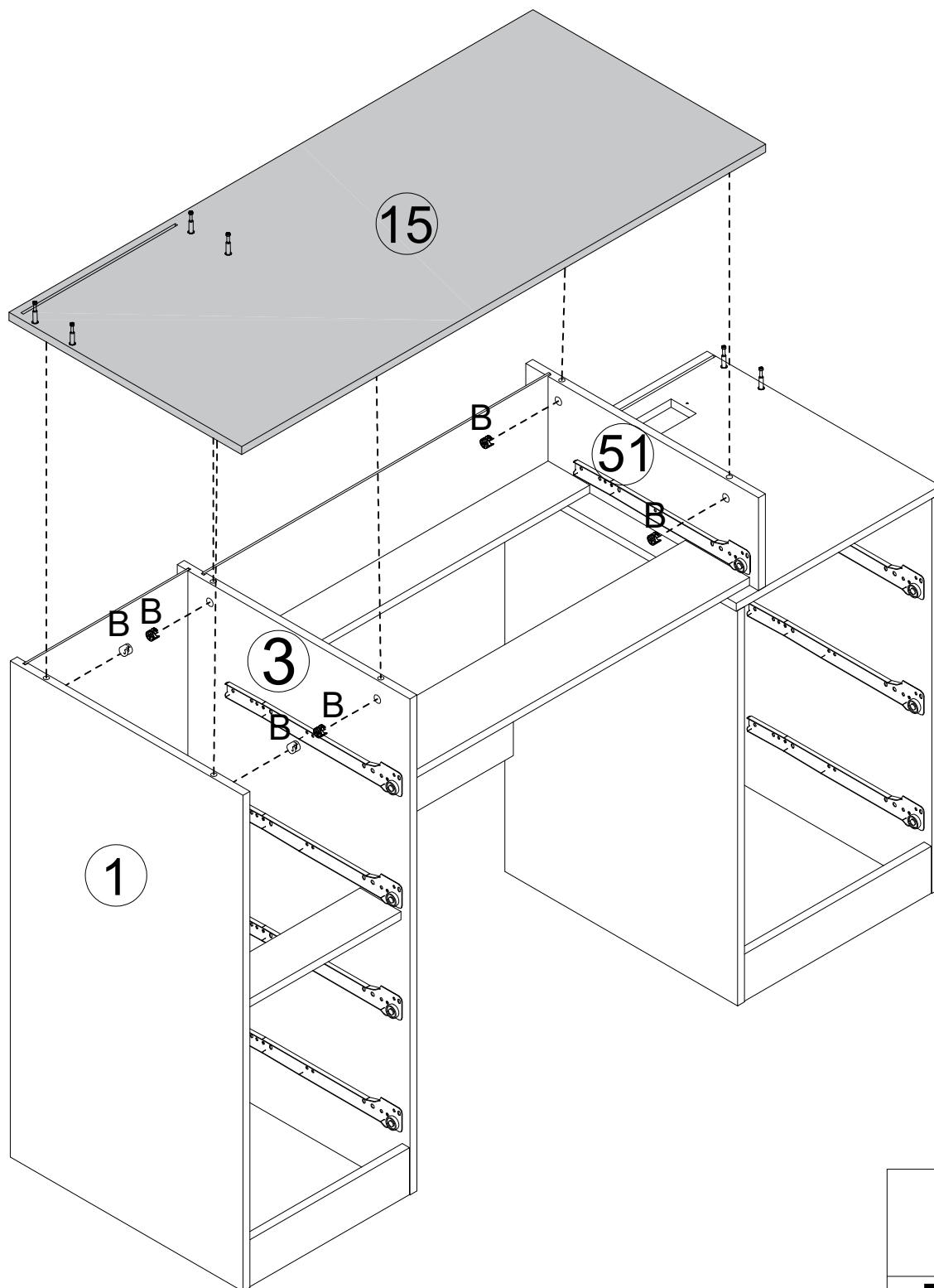
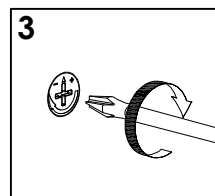
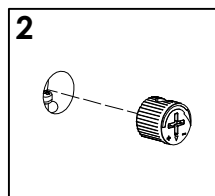
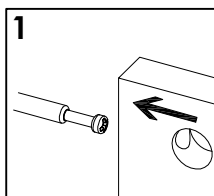
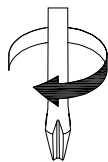

Bx6

# STEP38

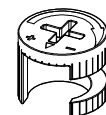
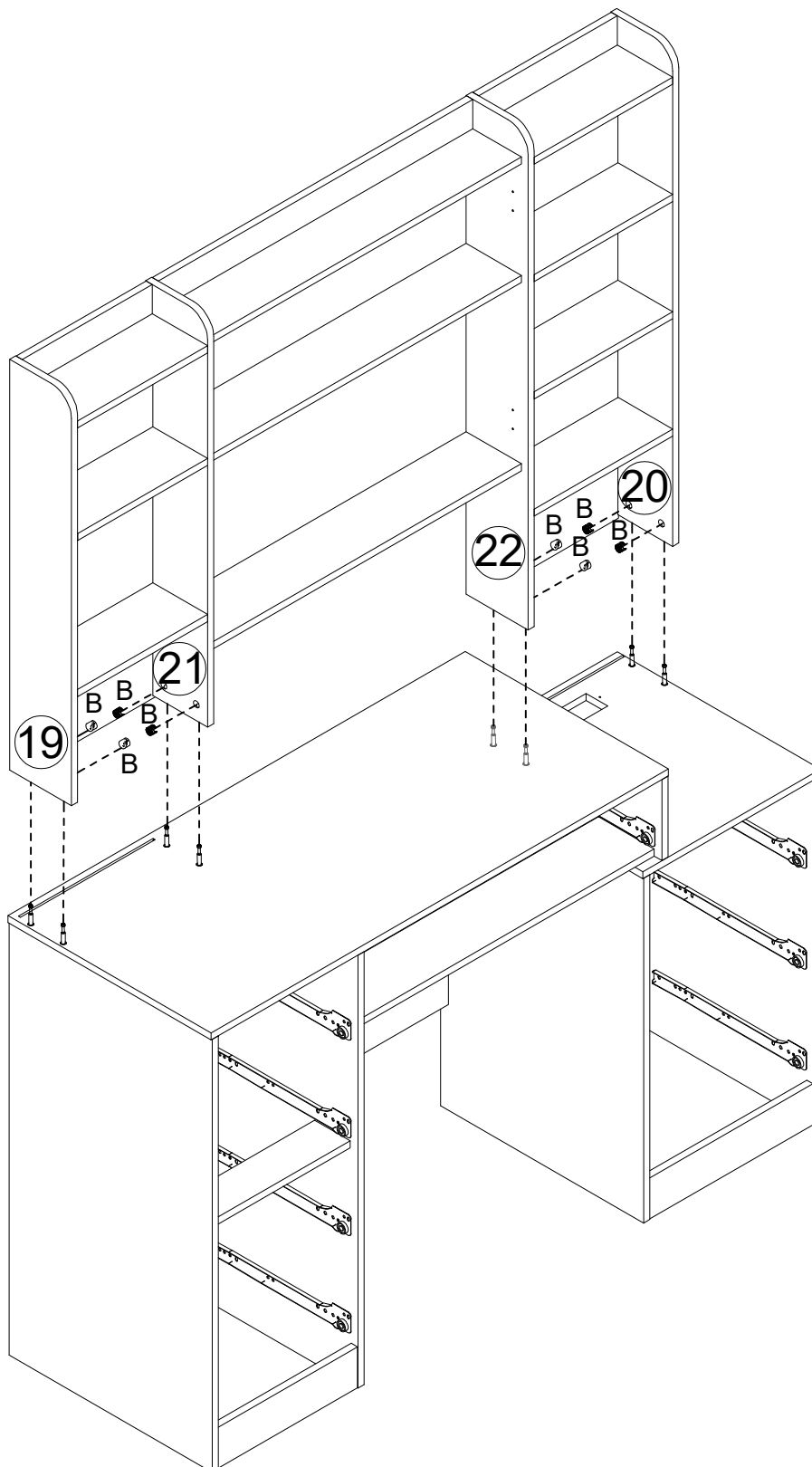
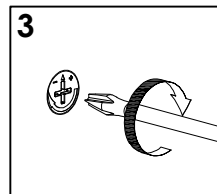
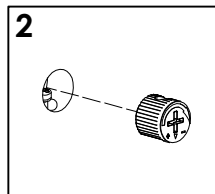
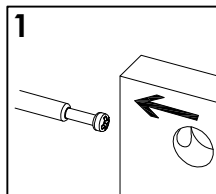
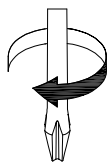

Bx8

# STEP39

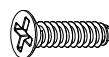
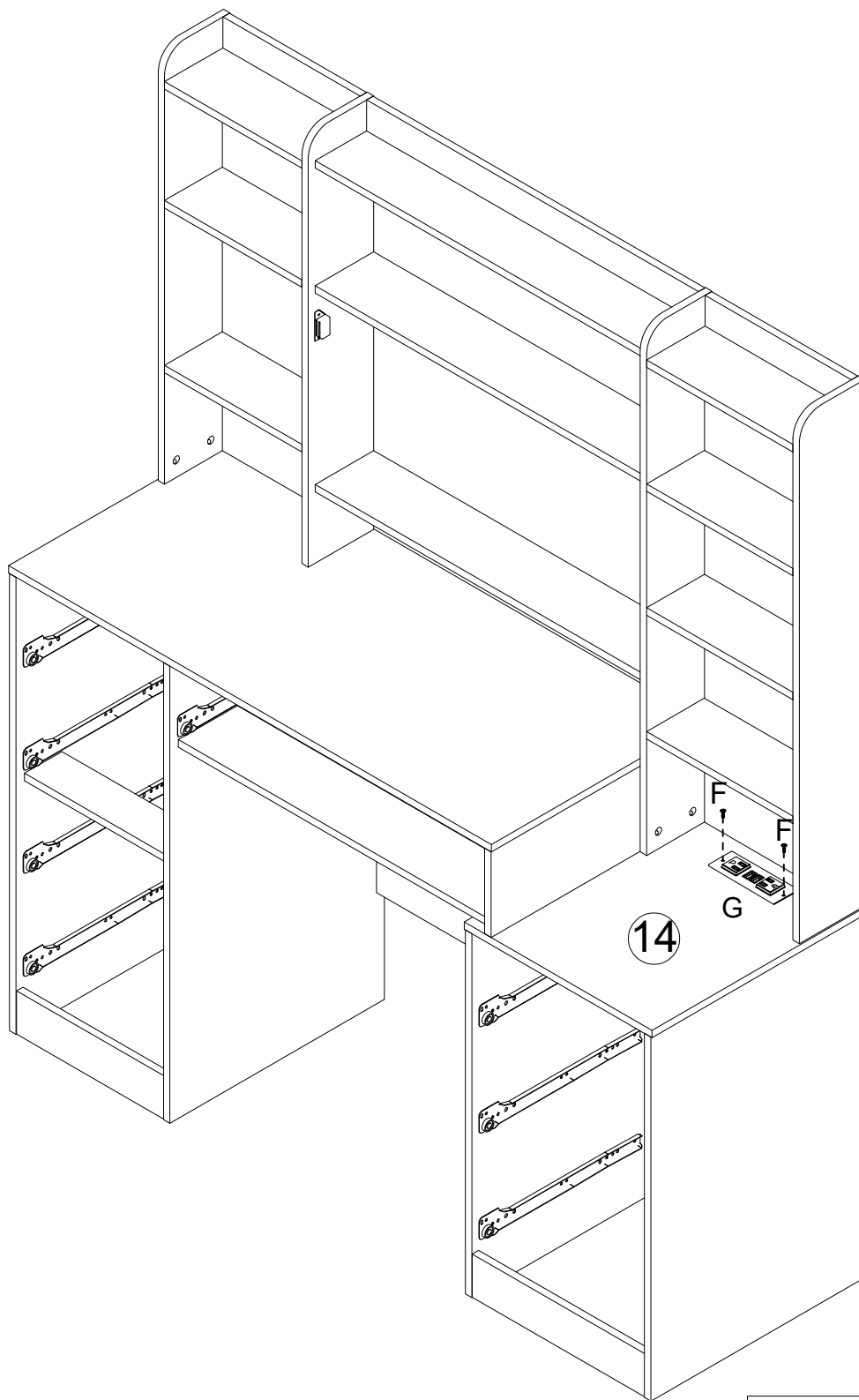

Fx2



Gx1

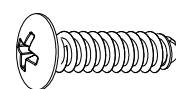
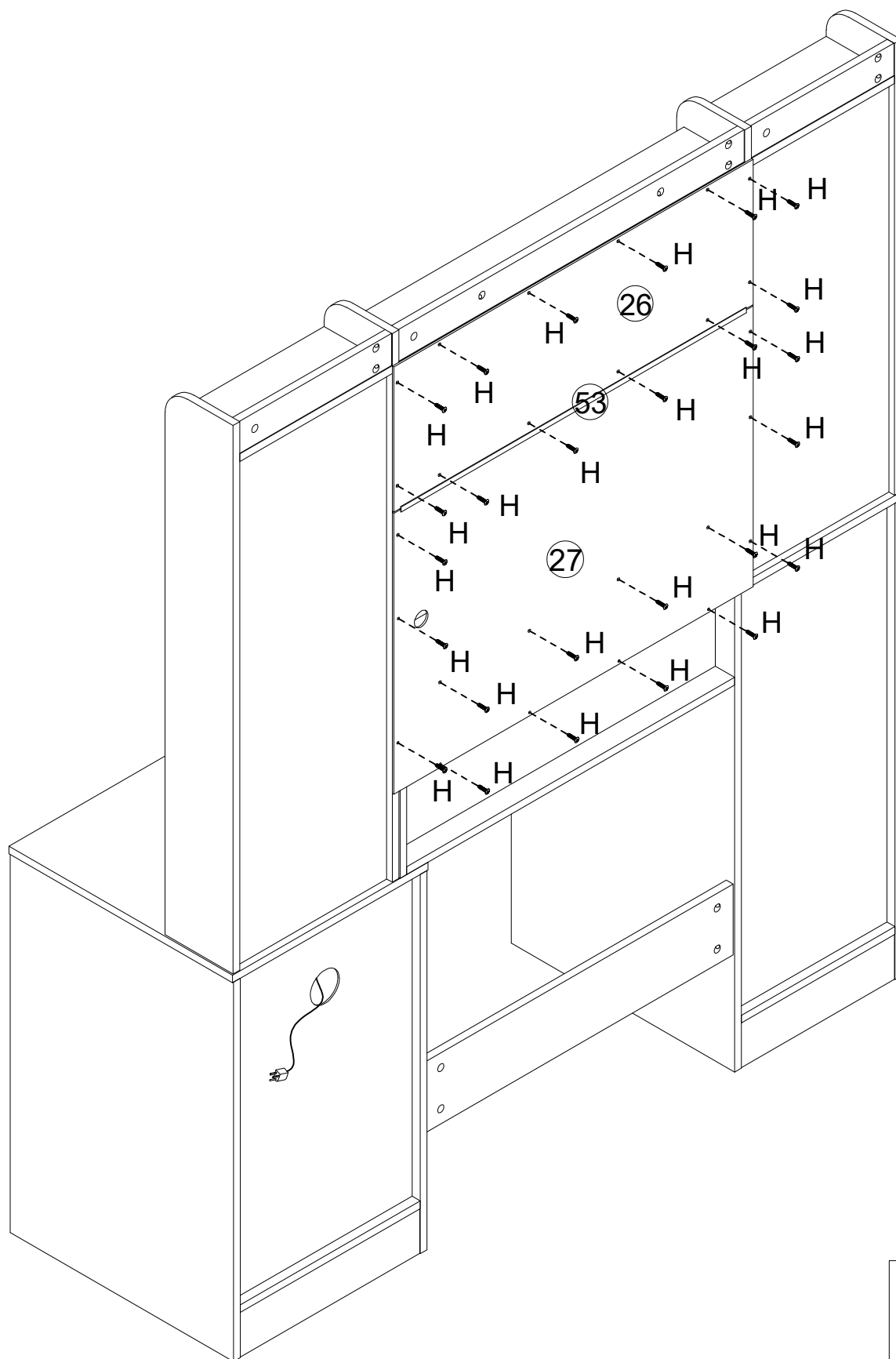
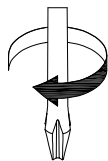

# STEP40

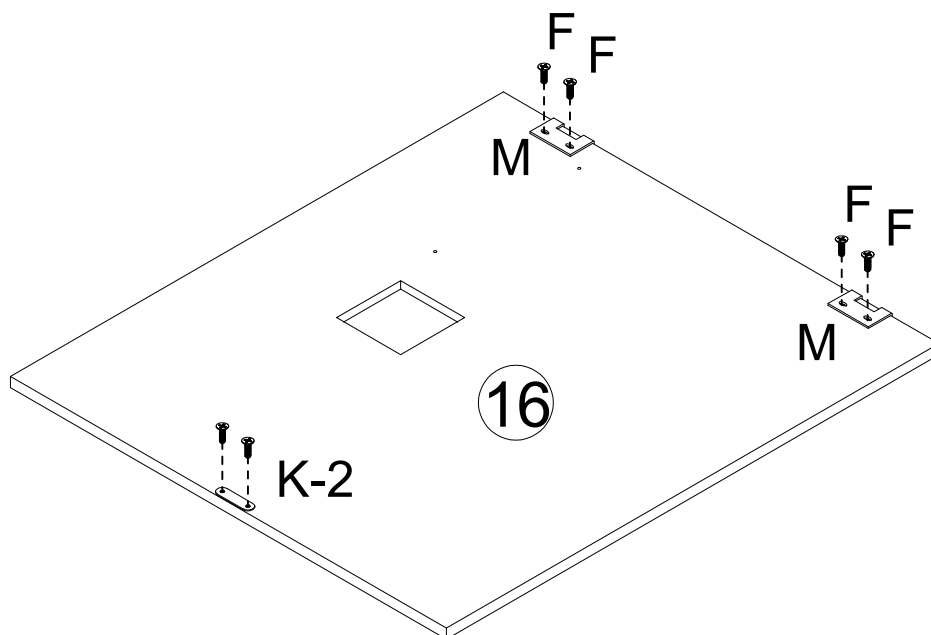
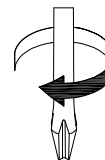

Hx26

# STEP41

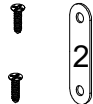

		
Fx4	K-2x1	Mx2

# STEP42

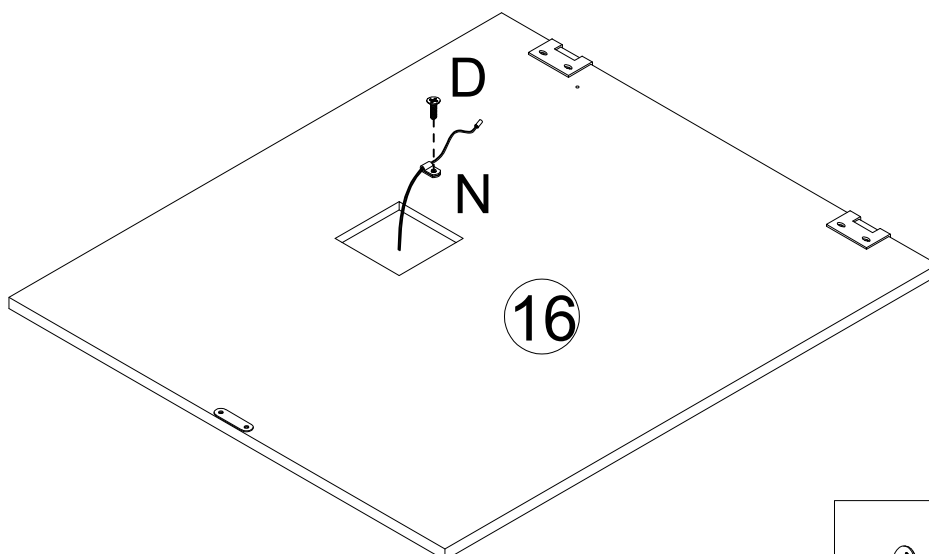

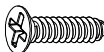
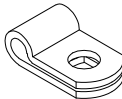

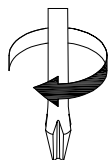

	
Dx1	Nx1

# STEP43

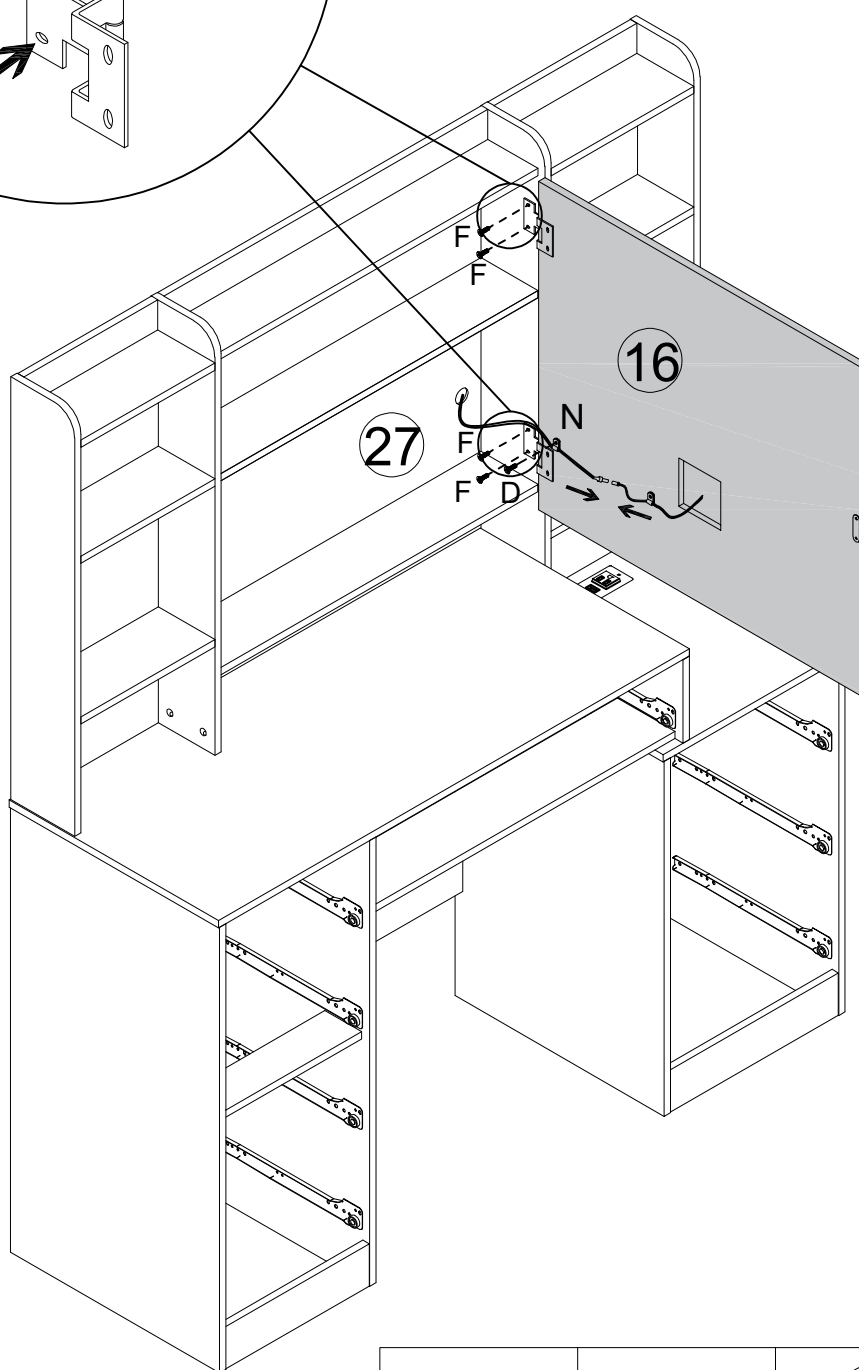
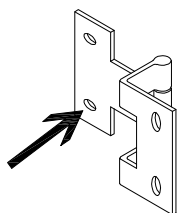

Adjusting the hole indicated on this hinge can move the mirror panel forward or backward.

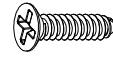
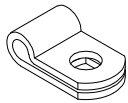

			
<b>Dx1</b>	<b>Fx4</b>	<b>Nx1</b>	<b>x1</b>

# STEP44

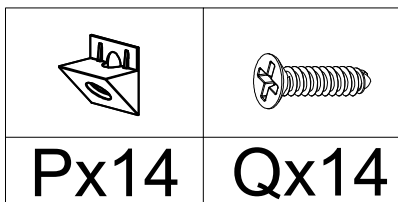
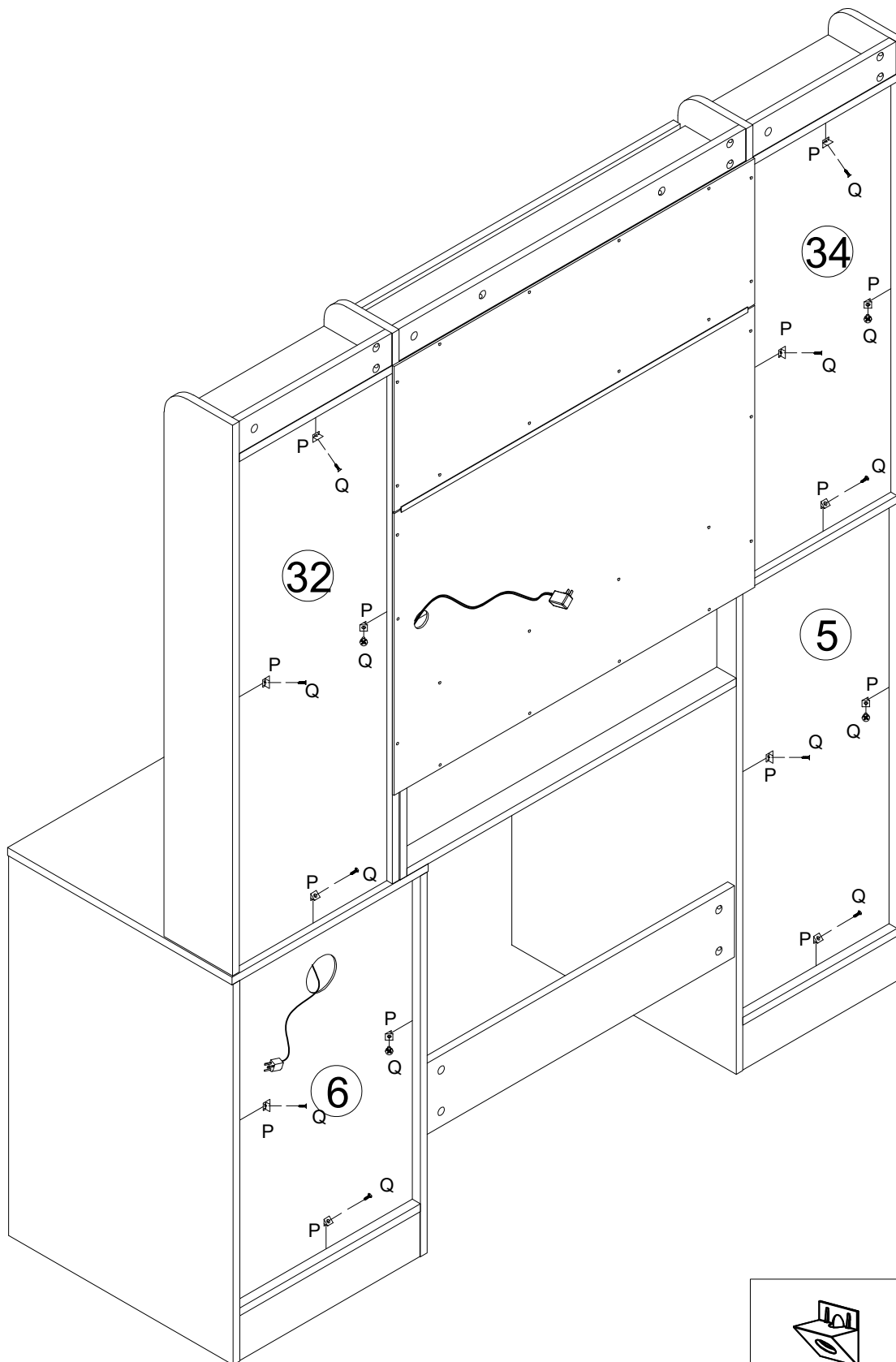
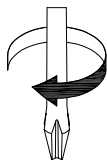

# STEP45x4

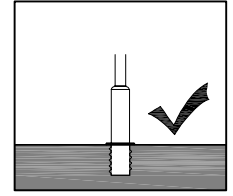
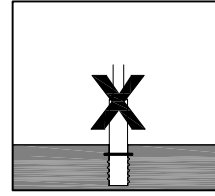
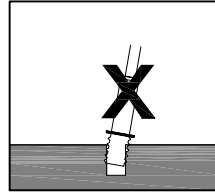
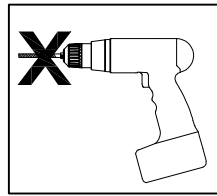

Iron Rod A is prohibited from using an electric drill.

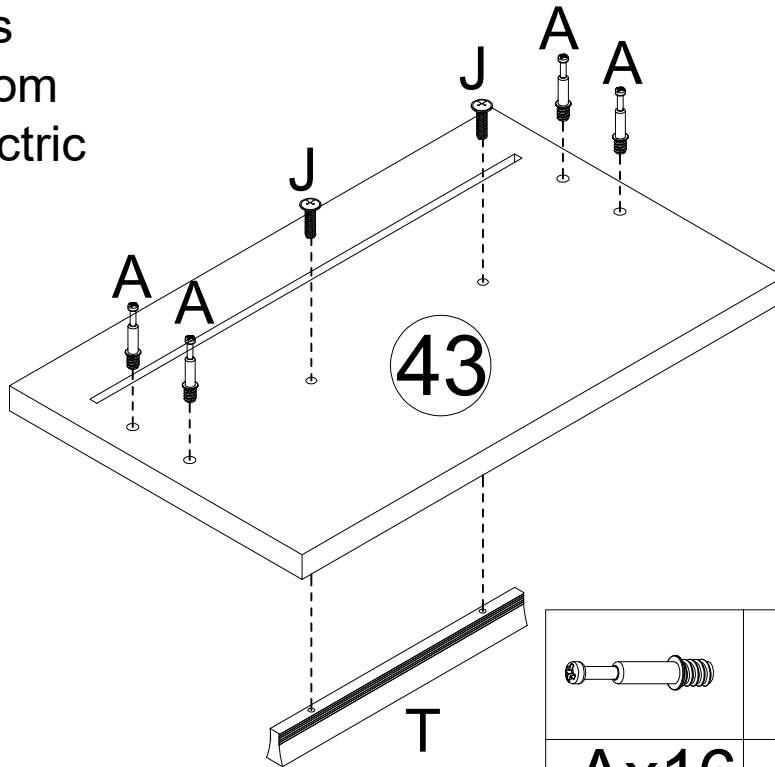

Ax16	Jx8	Tx4

# STEP46x4

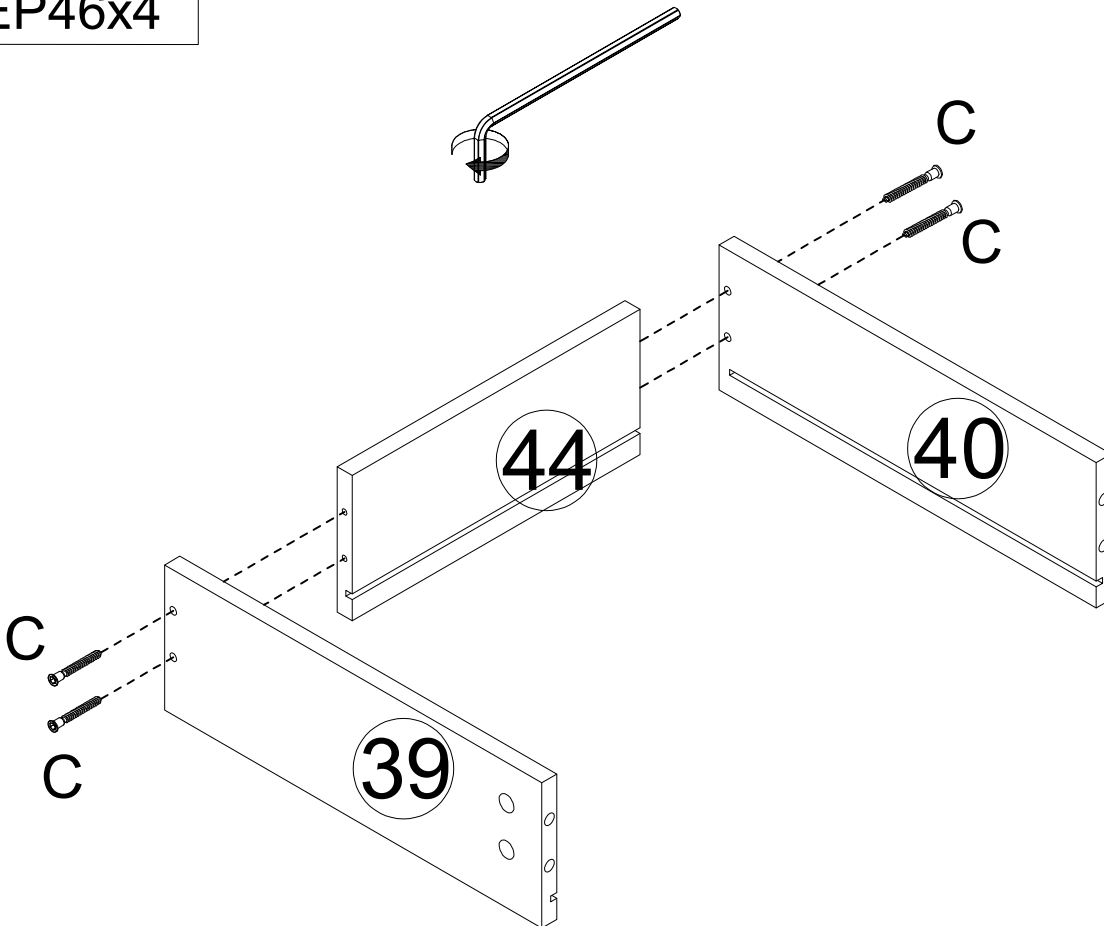

Cx16

# STEP47x4

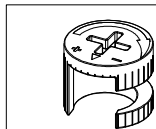
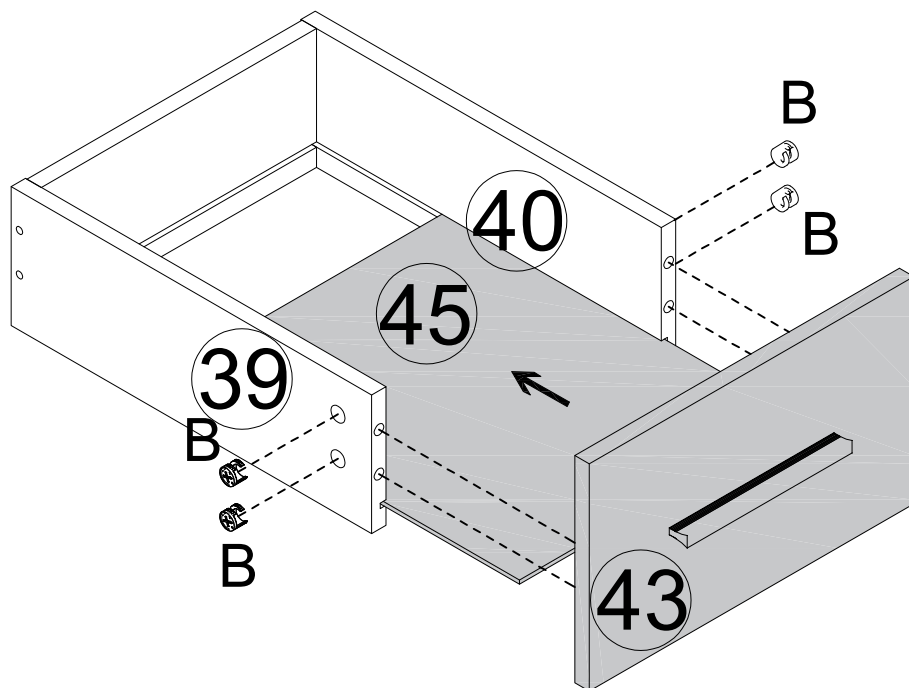
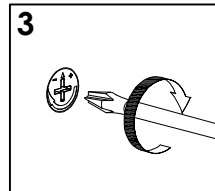
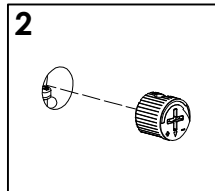
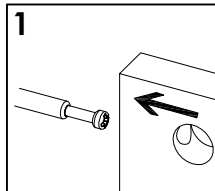
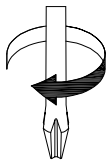

**Bx16**

# STEP48x4

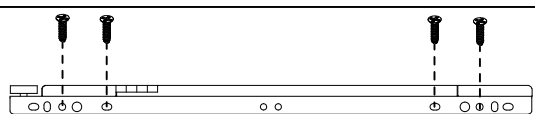
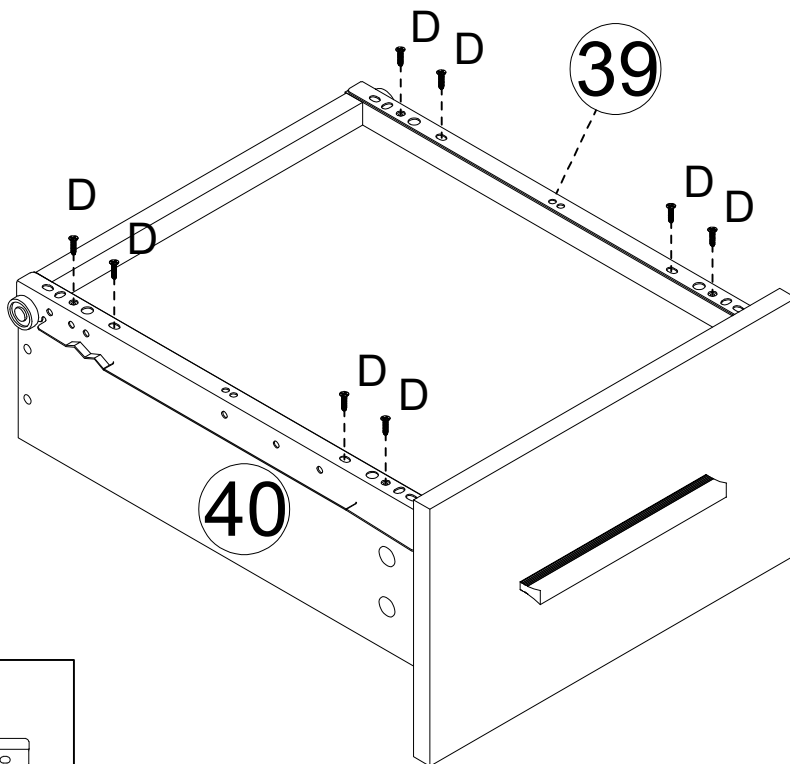
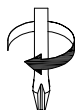

**E-DLx4**

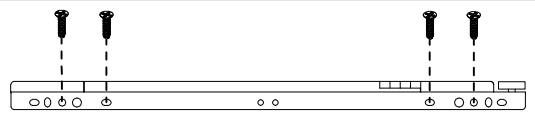

**E-DRx4**

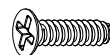

**Dx32**

# STEP49x3

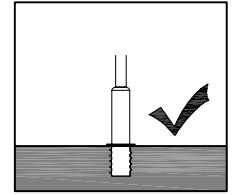
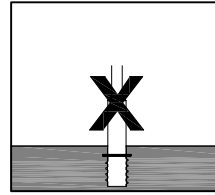
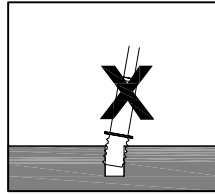
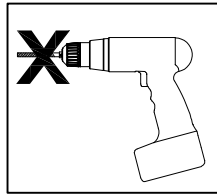

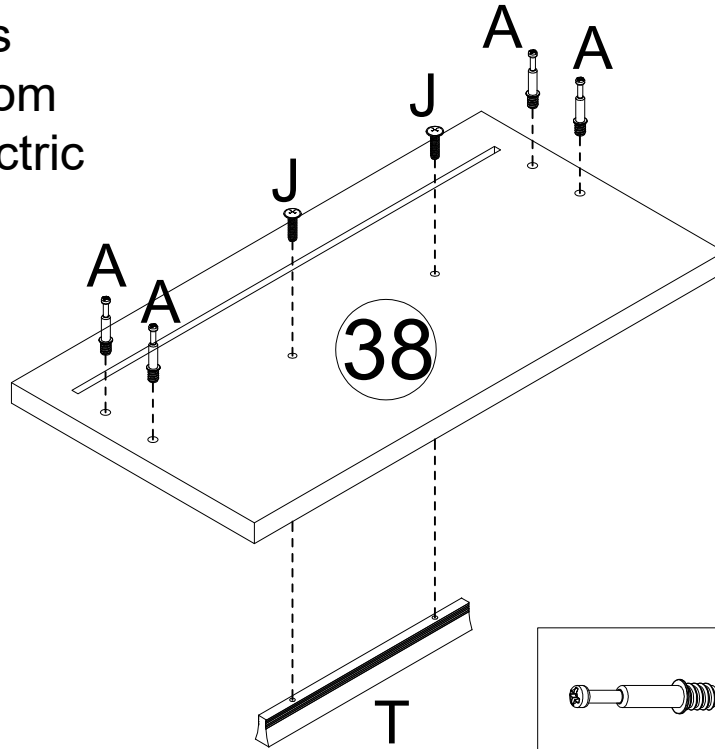

Iron Rod A is prohibited from using an electric drill.

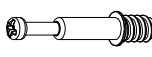
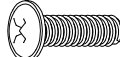
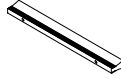

		
Ax12	Jx6	Tx3

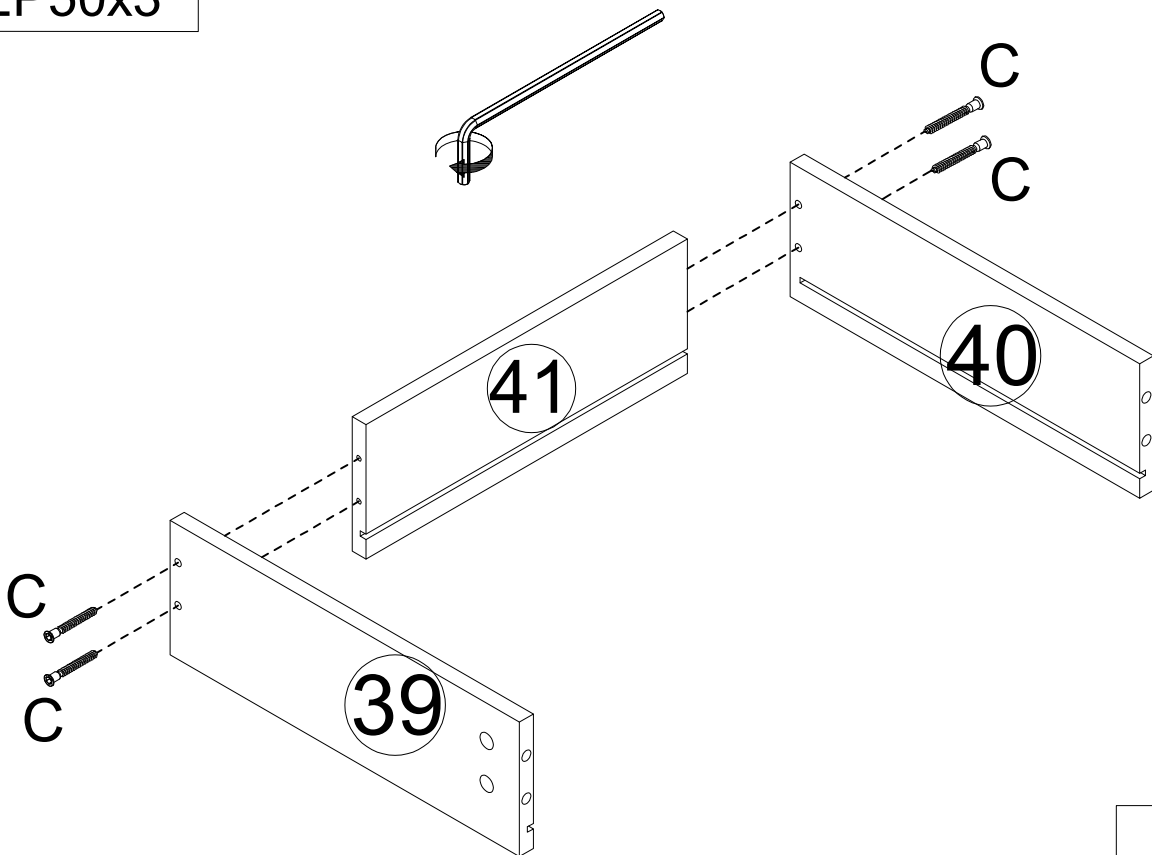
# STEP50x3



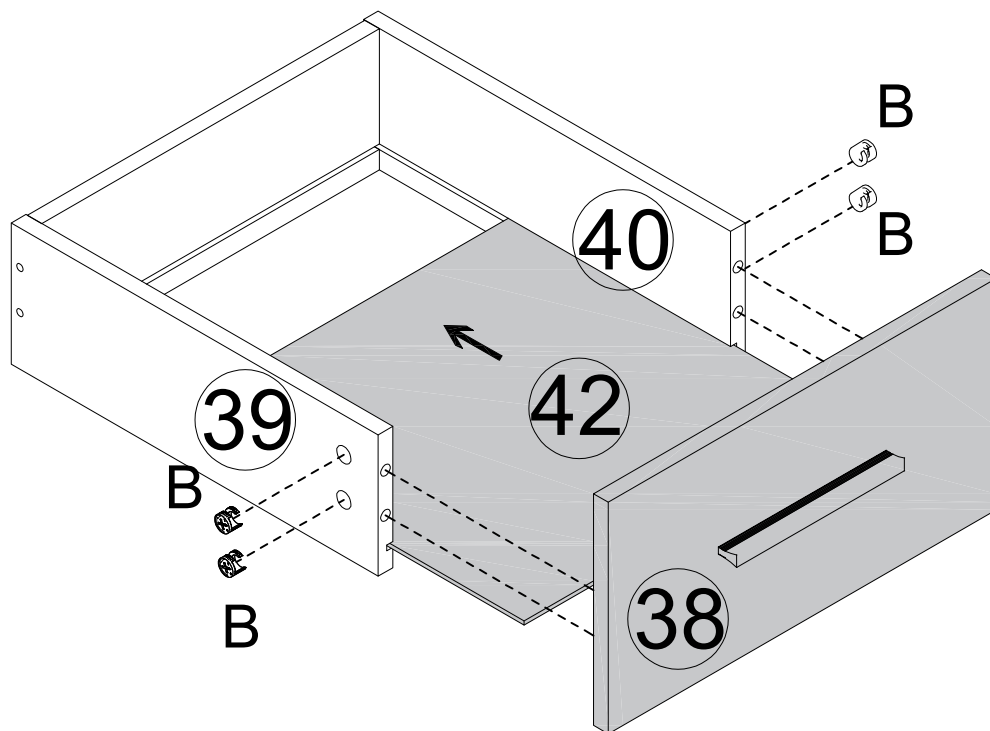
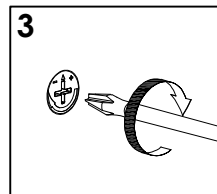
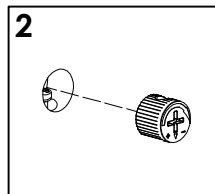
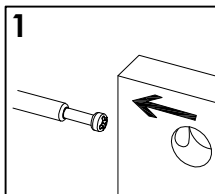
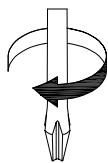

Cx12

# STEP51x3

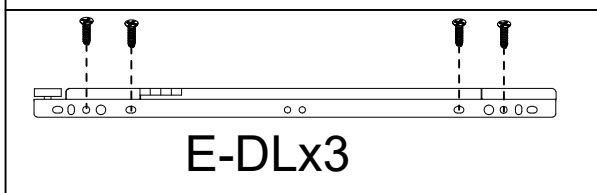
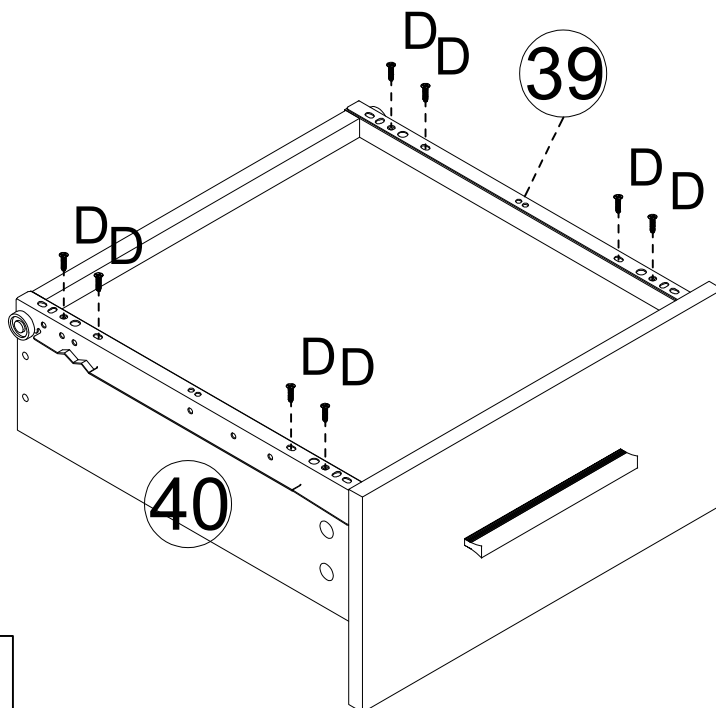

# STEP52x3



E-DLx3



E-DRx3

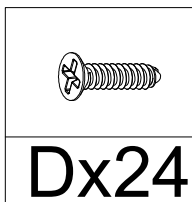

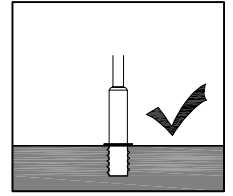
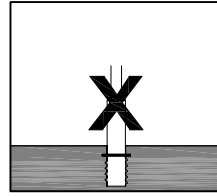
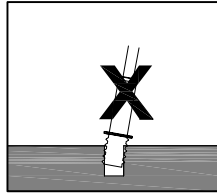
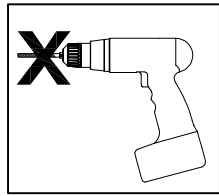

# STEP53



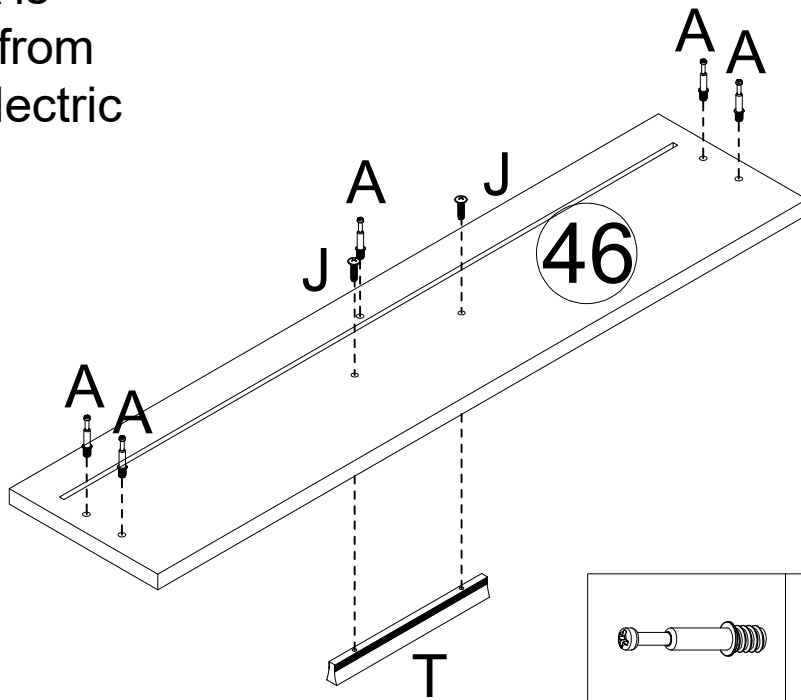

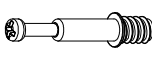
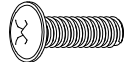
Iron Rod A is prohibited from using an electric drill.

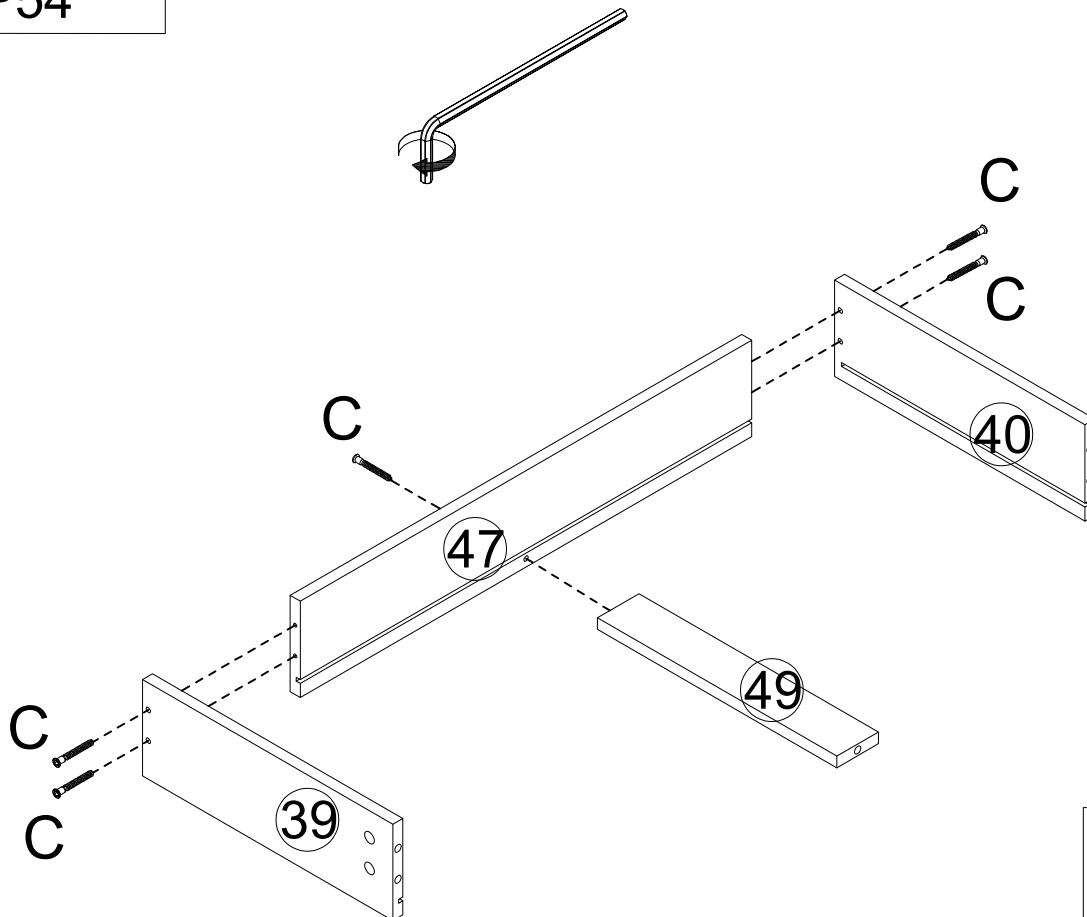

		
Ax5	Jx2	Tx1

# STEP54



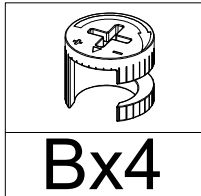
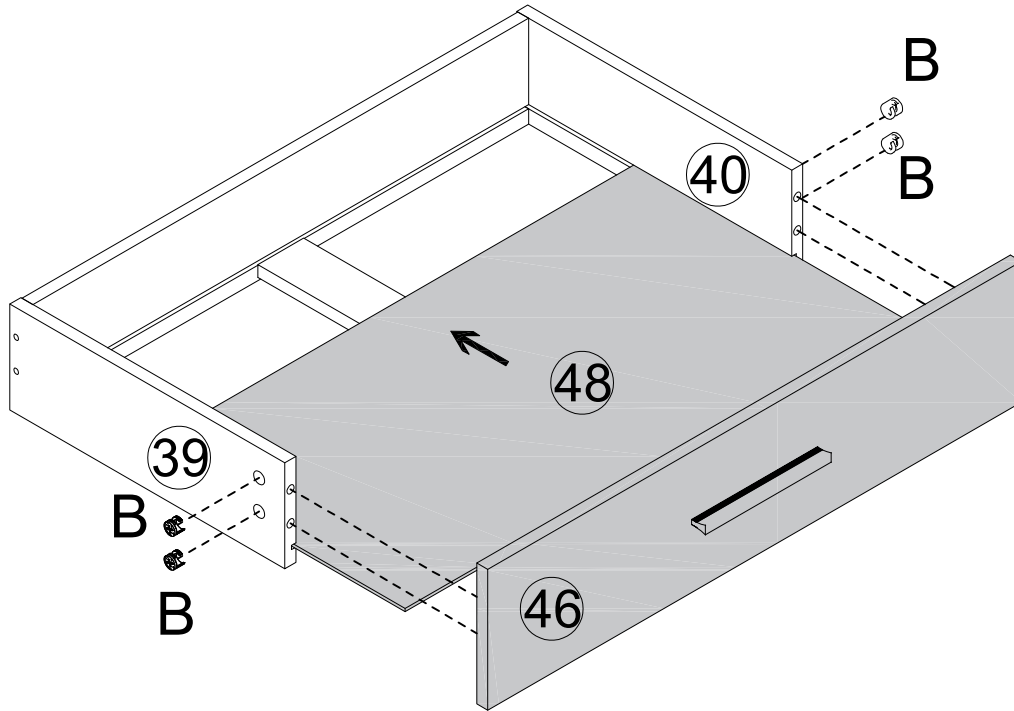
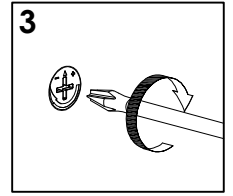
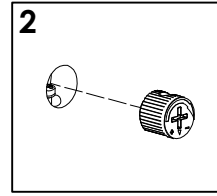
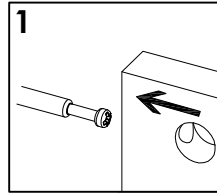
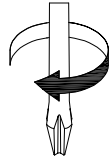

Cx5

# STEP55

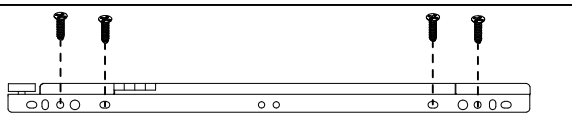
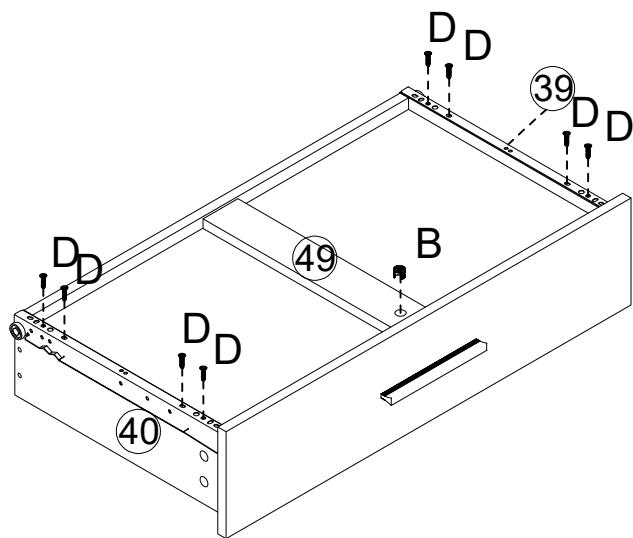
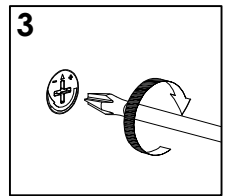
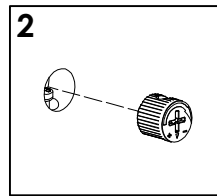
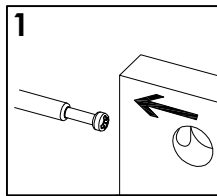
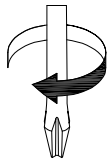

# STEP56



E-DLx1

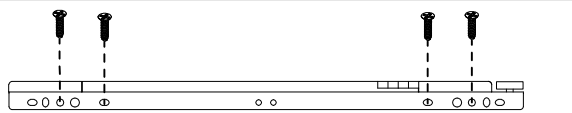

E-DRx1

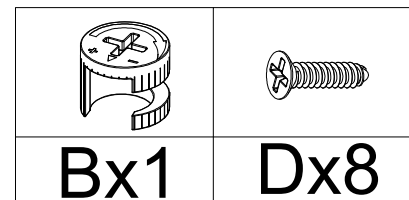

# STEP 57

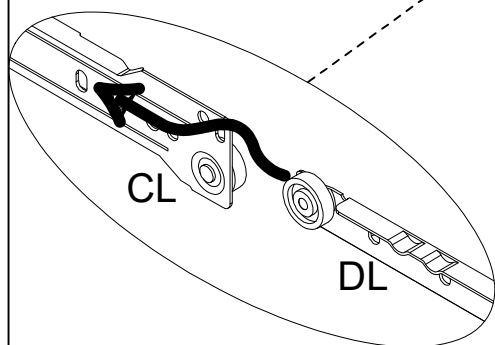
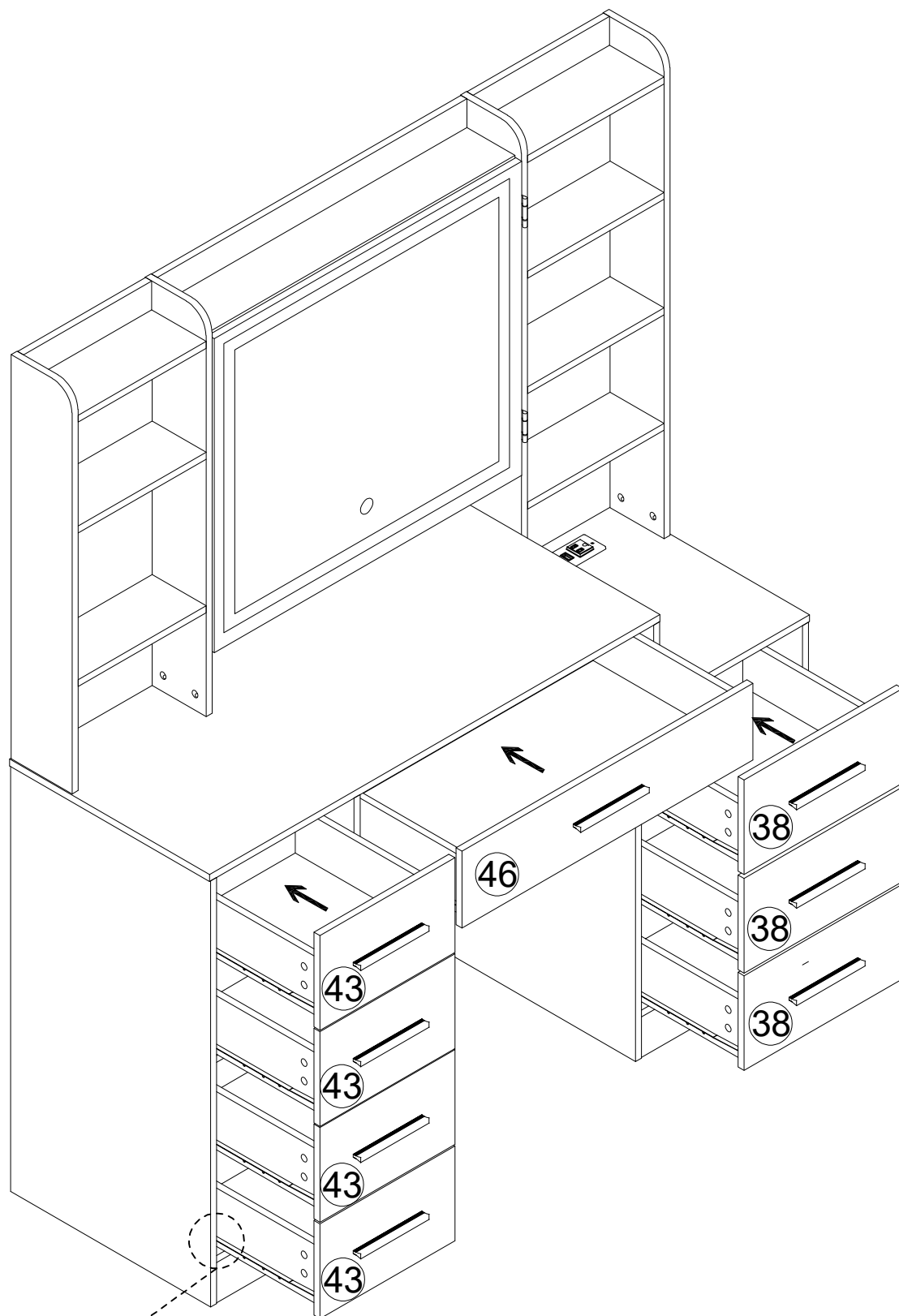

# STEP58

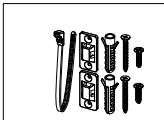
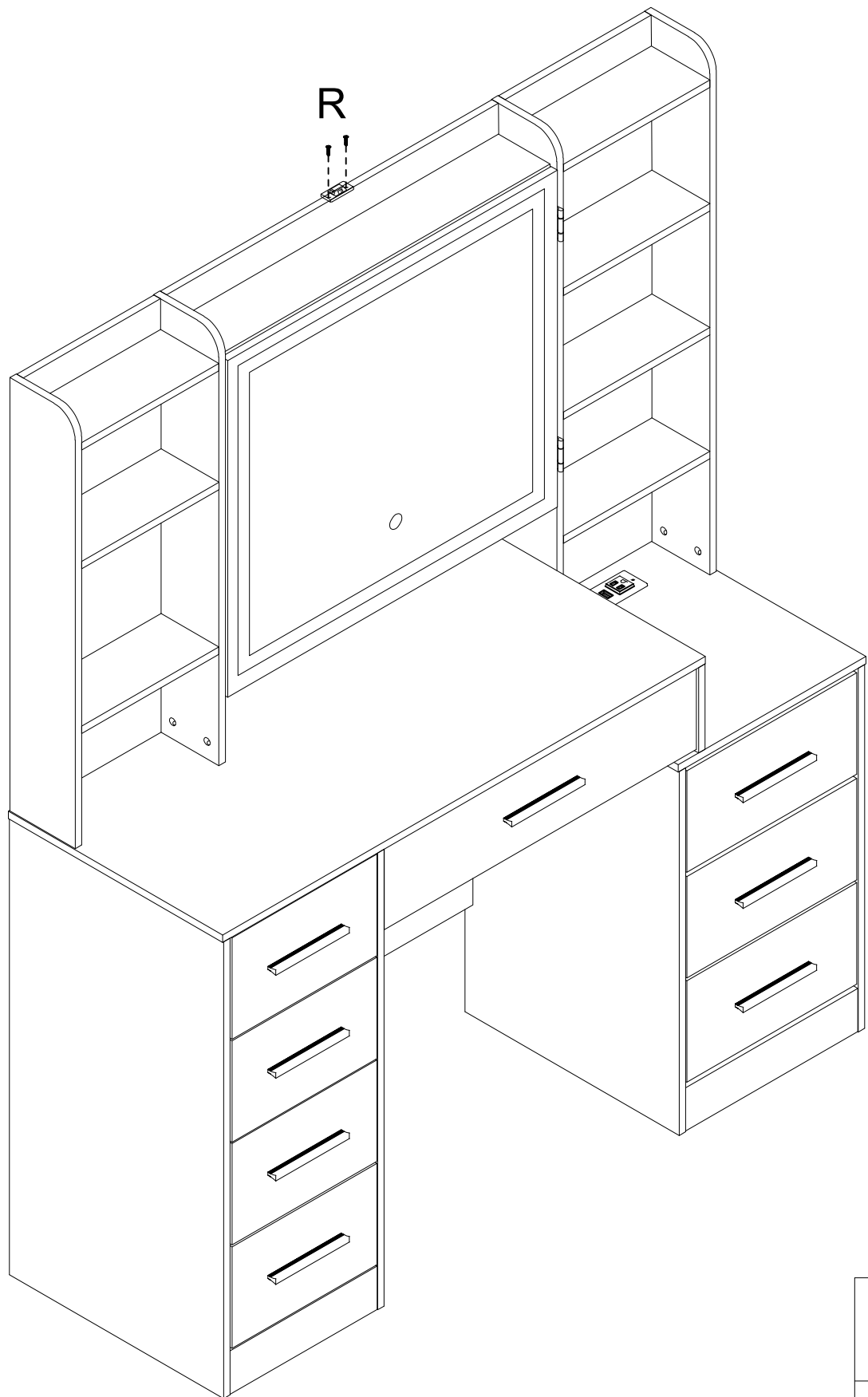
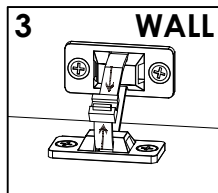
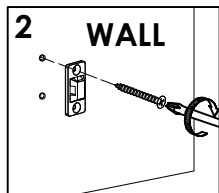
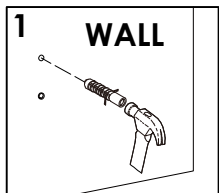
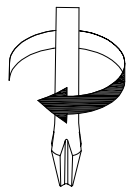

Rx1

# STEP59

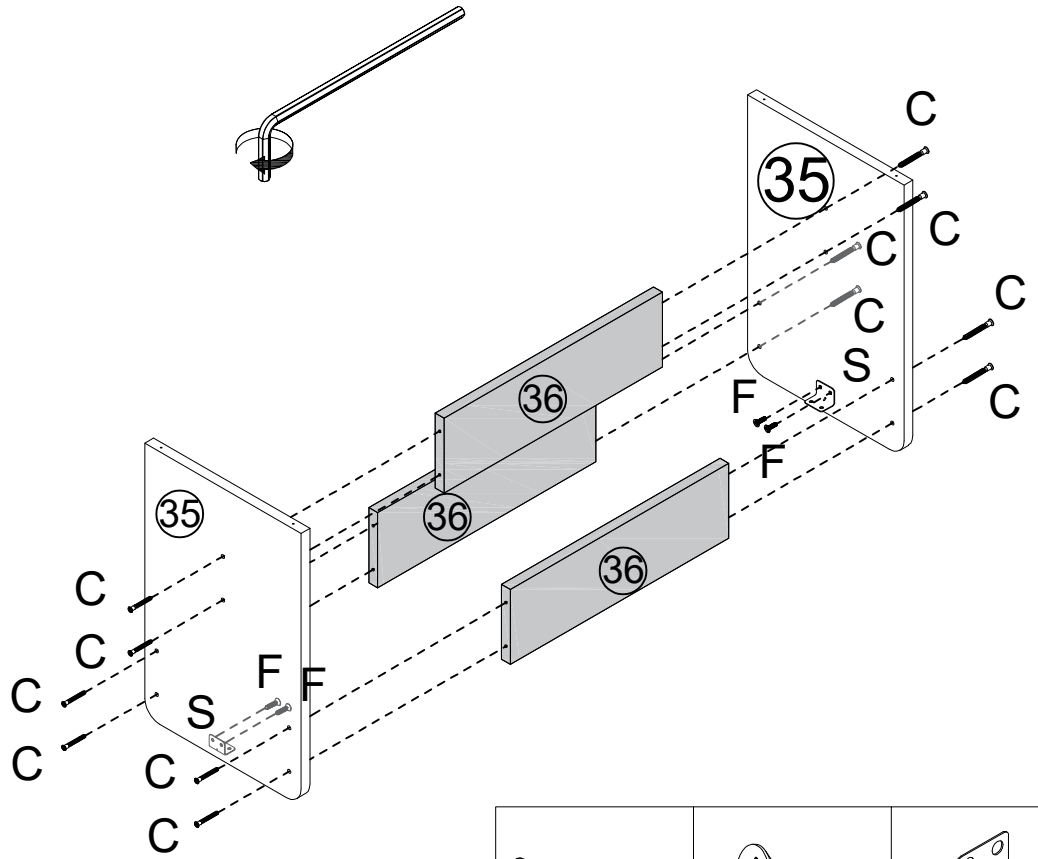
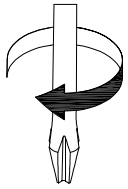

<b>Cx12</b>	<b>Fx4</b>	<b>Sx2</b>

# STEP60

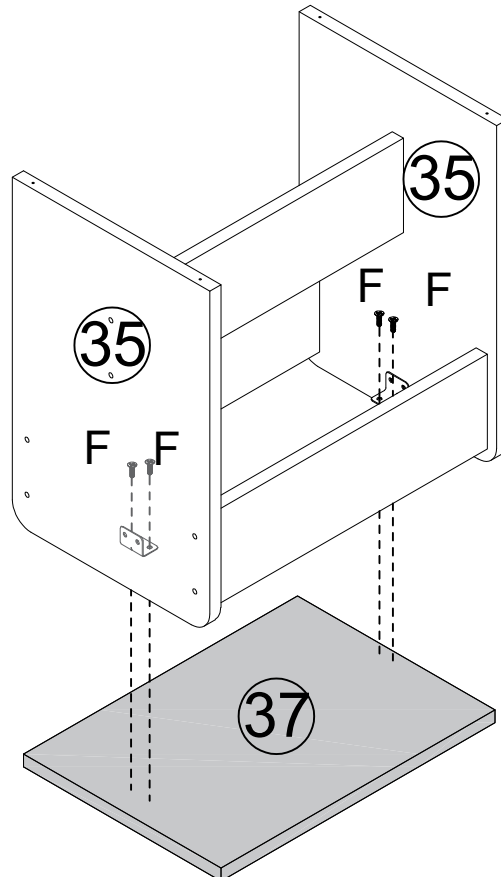
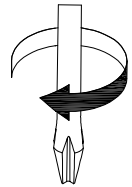

<b>Fx4</b>