

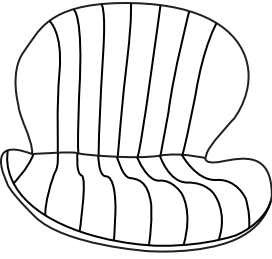
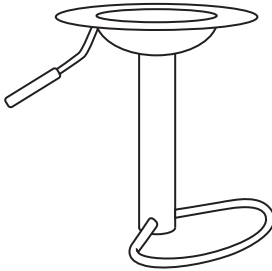
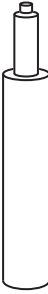
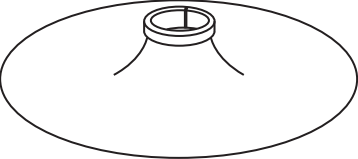

INSTRUCTION MANUAL

Bar Chair

PARTS DESCRIPTION

A	B	C	D	E
				<p data-bbox="1356 369 1484 414">M6*16</p>  <p data-bbox="1412 481 1460 526">x4</p> 

ASSEMBLE STEPS

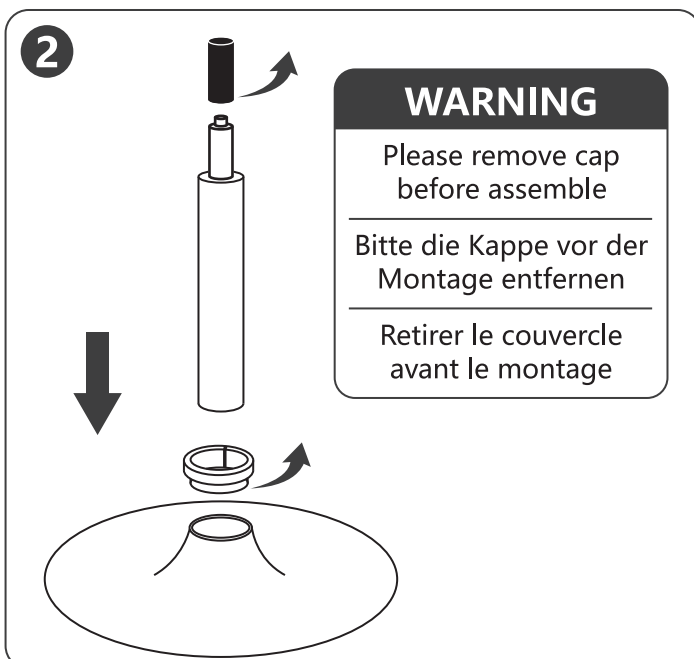
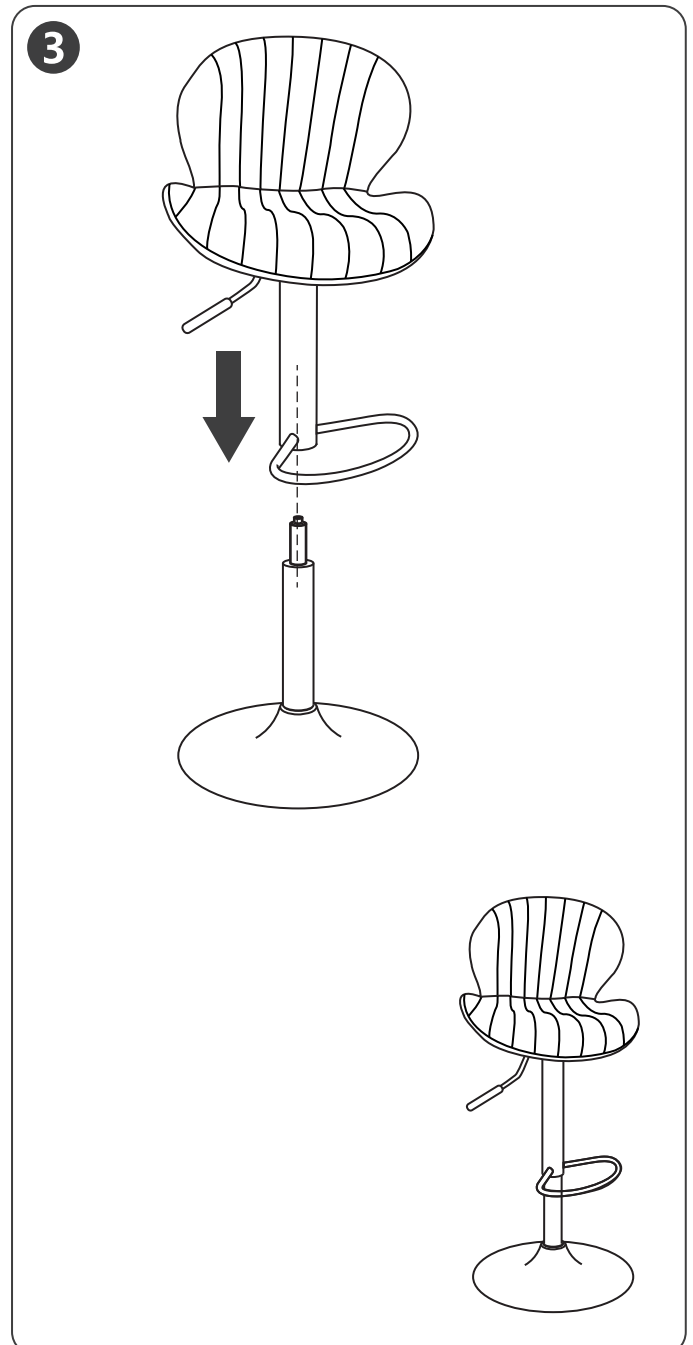
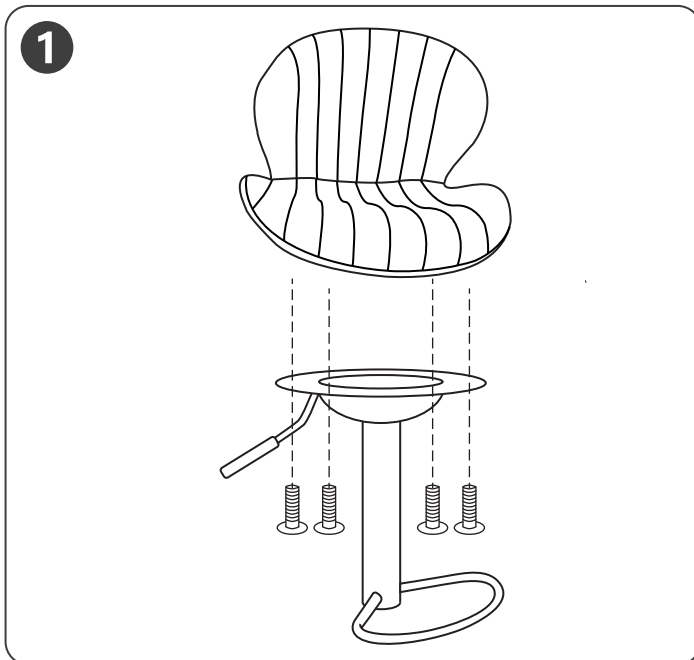

If the product lacks any accessories or the product has any quality problems, please contact us in time, we will give you a satisfactory answer in time.