

Tools Required:

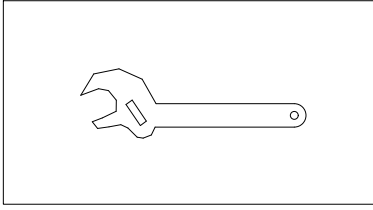

Adjustable Wrench

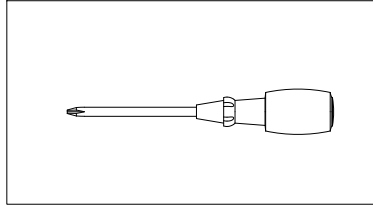

Philips Screwdriver

Before Installation

1. Please read these instructions before assembling or installing the product. NOTE: Installation by a licensed electrician is recommended.
2. Take out the fixture and the mounting package and make sure all parts are included. If any part is missing or damaged, please contact us.
3. All parts must be used as indicated in these instructions. Do not substitute any parts, leave parts out, or use any parts that are worn out or broken.
4. Do not disassemble the main body, as it has been installed & commissioned correctly & precisely before leaving the factory.
5. IMPORTANT: Turn off the main power at the circuit breaker and place the wall switch or pull chain in the "OFF" position.
6. Do not use bulbs with wattage greater than specified on this fixture.

Parts List

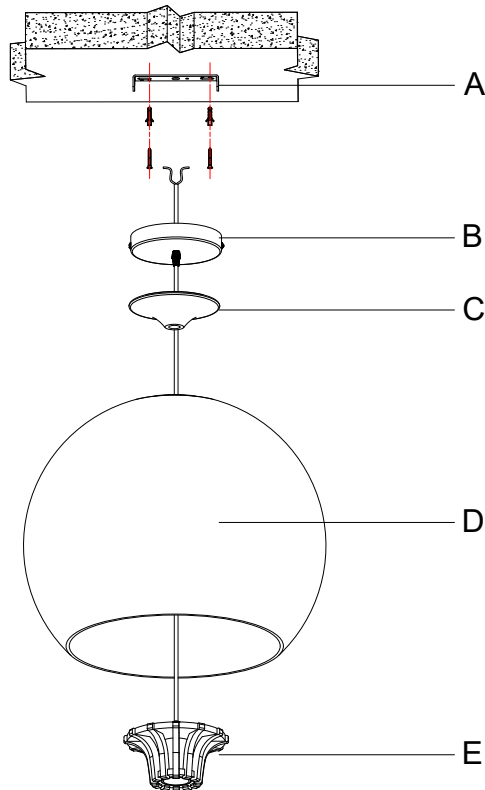

Part	Quantity
A	1
B	1
C	1
D	1
E	1

Installation Guide

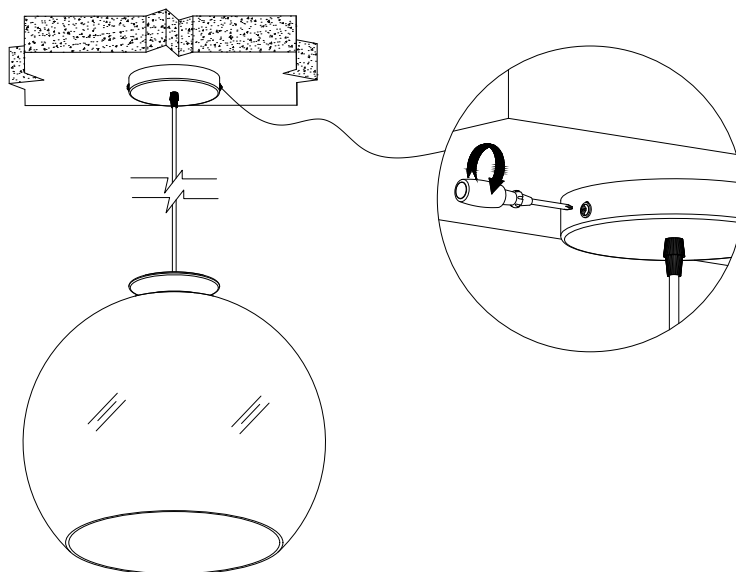
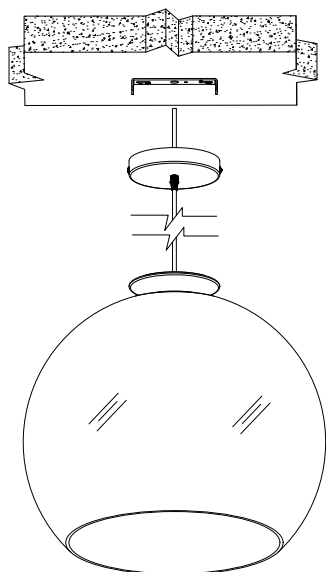
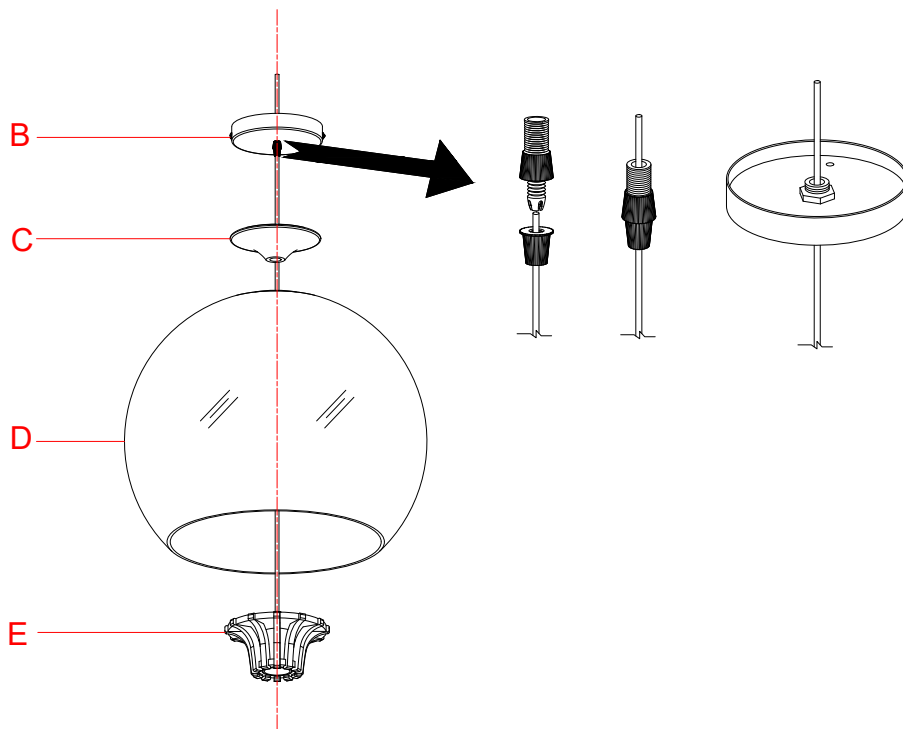
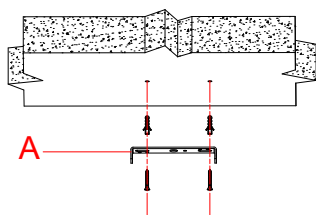

Troubleshooting

Problem	Possible Cause	Corrective Action
Fixture does not light	<ol style="list-style-type: none"> 1. Fixture may be wired incorrectly. 2. Worn or broken bulb. 3. Lamp socket or LED transformer (if applicable) may go bad. 	<ol style="list-style-type: none"> 1. Check wiring. 2. Replace bulb. 3. Replace lamp socket or LED transformer (if applicable).
Light bulb flickers.	<ol style="list-style-type: none"> 1. Switch Contacts are bad. 2. Wire connections are loose. 3. Light bulb socket may go bad. 	<ol style="list-style-type: none"> 1. Replace the switch. 2. Check wire connections 3. Replace the socket.