

ASSEMBLY INSTRUCTIONS

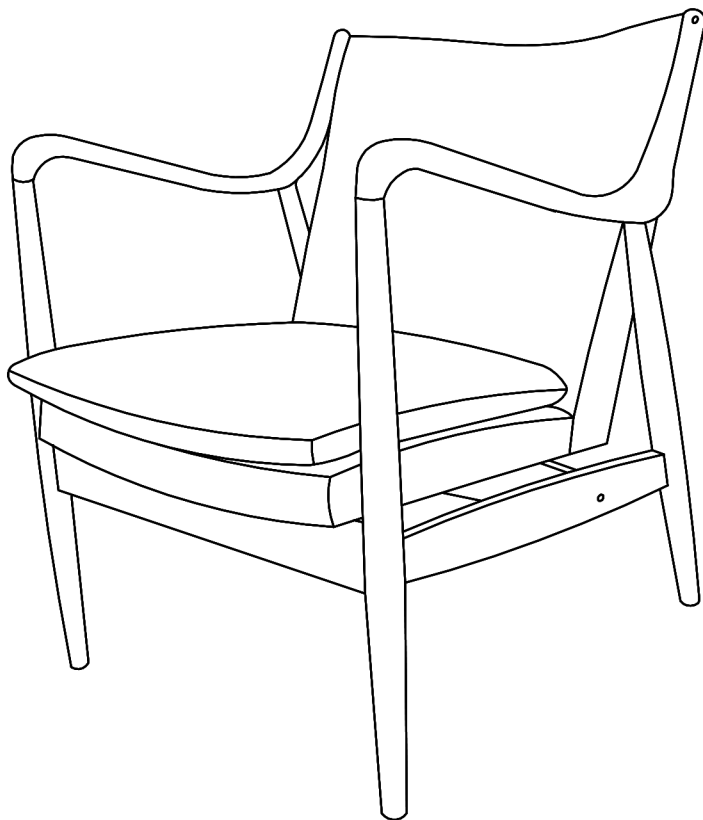

TOOLS REQUIRED



Allen Wrench

(Included)



**Phillips
Screwdriver**

(Not Included)



**2 - Persons
Recommended**

ASSEMBLY RATING



EASY —————> DIFFICULT

The Assembly Rating is a 5-point system showing the level of effort needed to assemble a specific product.



CHECK BEFORE STARTING

Are you missing anything?

Double-check all parts, hardware and accessories listed on Page 6 are accounted for.

Should we send any replacements?

Are there any irregularities or flaws in the parts? We can send replacements!

Check out our Quick Tips!

We recommend reviewing the pre-assembly handouts. Even experts need a refresher now and then!

Prep Time!

Please review the assembly instructions and all diagrams prior to assembling. Arrange parts as recommended on Page 7 and group identical hardware together to make assembling easier.

PRE ASSEMBLY INTRODUCTION

We understand building ready-to-assemble furniture can be a challenging experience for some. To help avoid confusion, we have provided some helpful tips that may speed up the process.

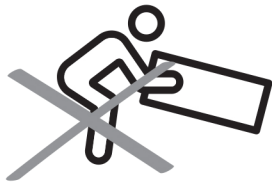

Teamwork

ALWAYS have at least two people to help with transporting and assembling the product to avoid potential injury and/or damage.

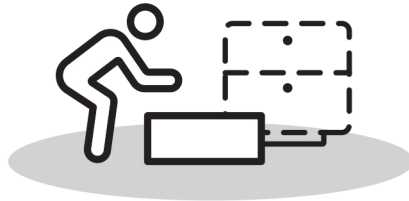
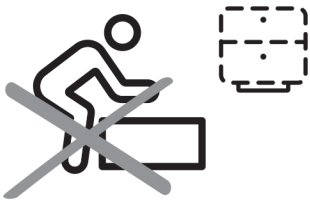

Suitable Location

Assembling near the area of the intended location is highly recommended.



Sufficient Space

Make sure you have enough space to move around during the assembly.



Avoid Scratches

Use cardboard, blankets or a carpeted area while assembling furniture to prevent scratches.

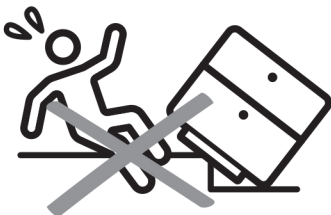

Flat Surface

Make sure the furniture rests on a flat and level surface with each leg evenly touching the floor.

ASSEMBLY AND CARE ADVICE



FAILURE TO FOLLOW THE GUIDELINES BELOW MAY RESULT IN INJURY AND/OR PROPERTY DAMAGE.



Position each part correctly and insert screws or bolts into their respective holes.

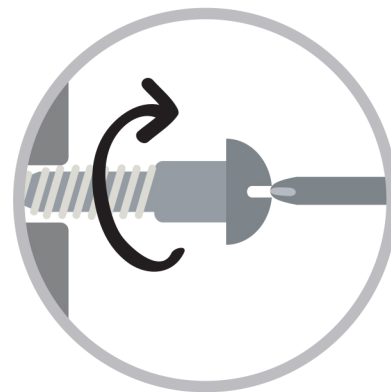

Turn clockwise to tighten and only tighten when step is completed or when instructed to do so.



Use the appropriate hand tools or power tools for assembly. Select steps, such as tightening screws and/or bolts, may require hand tools to avoid causing damage during assembly.



Save the instructions and store any supplied tools for later maintenance.

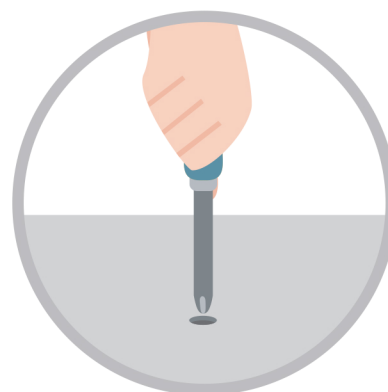

After two weeks, check and tighten any loose hardware and repeat again every six months thereafter.

IT IS THE USER'S RESPONSIBILITY TO MAINTAIN THE FURNITURE. THE HARDWARE MAY LOOSEN OVER TIME AND MAY CAUSE THE FURNITURE TO BE WOBBLY AND UNABLE TO SUPPORT ITS INTENDED WEIGHT CAPACITY. THIS MAY LEAD TO COLLAPSE AND MAY CAUSE SERIOUS INJURY.

CHAIR



• Please keep instructions for future reference.
 • Check the quantity and irregularity of parts and hardware before you start.

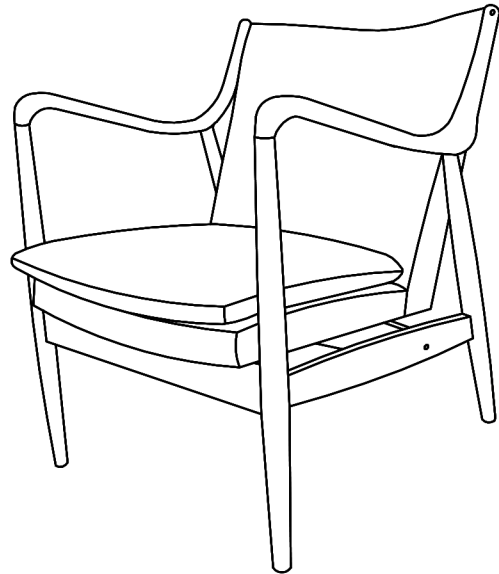

PARTS

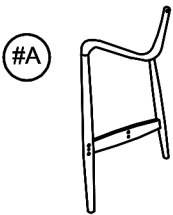

#A
 Arm Chair (Left)
 1pc

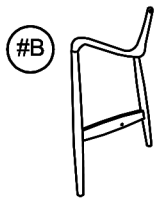

#B
 Arm Chair (Right)
 1pc

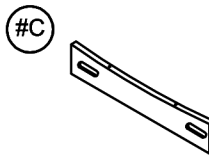

#C
 Front Rail
 1pc

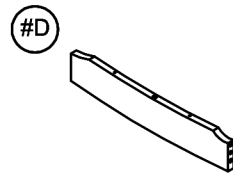

#D
 Rear Rail
 1pc

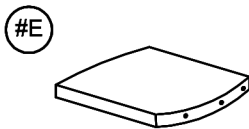

#E
 Seat Deck
 1pc

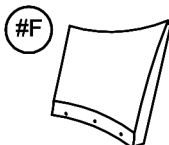

#F
 Back Rest
 1pc



#G
 Seat Deck
 1pc

HARDWARE

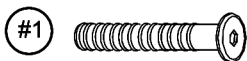

#1
 JCBC M6 x 40mm
 2pcs

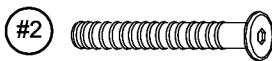

#2
 JCBC M6 x 50mm
 7pcs

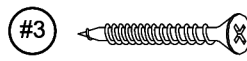

#3
 WOOD SCREW
 M4.0 x 50mm
 4pcs



#4
 WOOD DOWEL
 Ø10 x 30mm
 7pcs

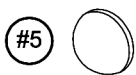

#5
 WOODEN CAP
 4pcs



#6
 ALLEN KEY M4
 1pc



#7
 FLAT WASHER
 3pcs

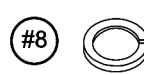

#8
 SPRING WASHER
 3pcs



#9
 U-WASHER
 2pcs

ASSEMBLY INSTRUCTIONS

1

- Part (#A) x1pc
- Part (#B) x1pc
- Part (#C) x1pc
- Part (#D) x1pc
- Hardware (#1) x2pcs
- Hardware (#2) x2pcs
- Hardware (#4) x7pcs
- Hardware (#9) x2pcs

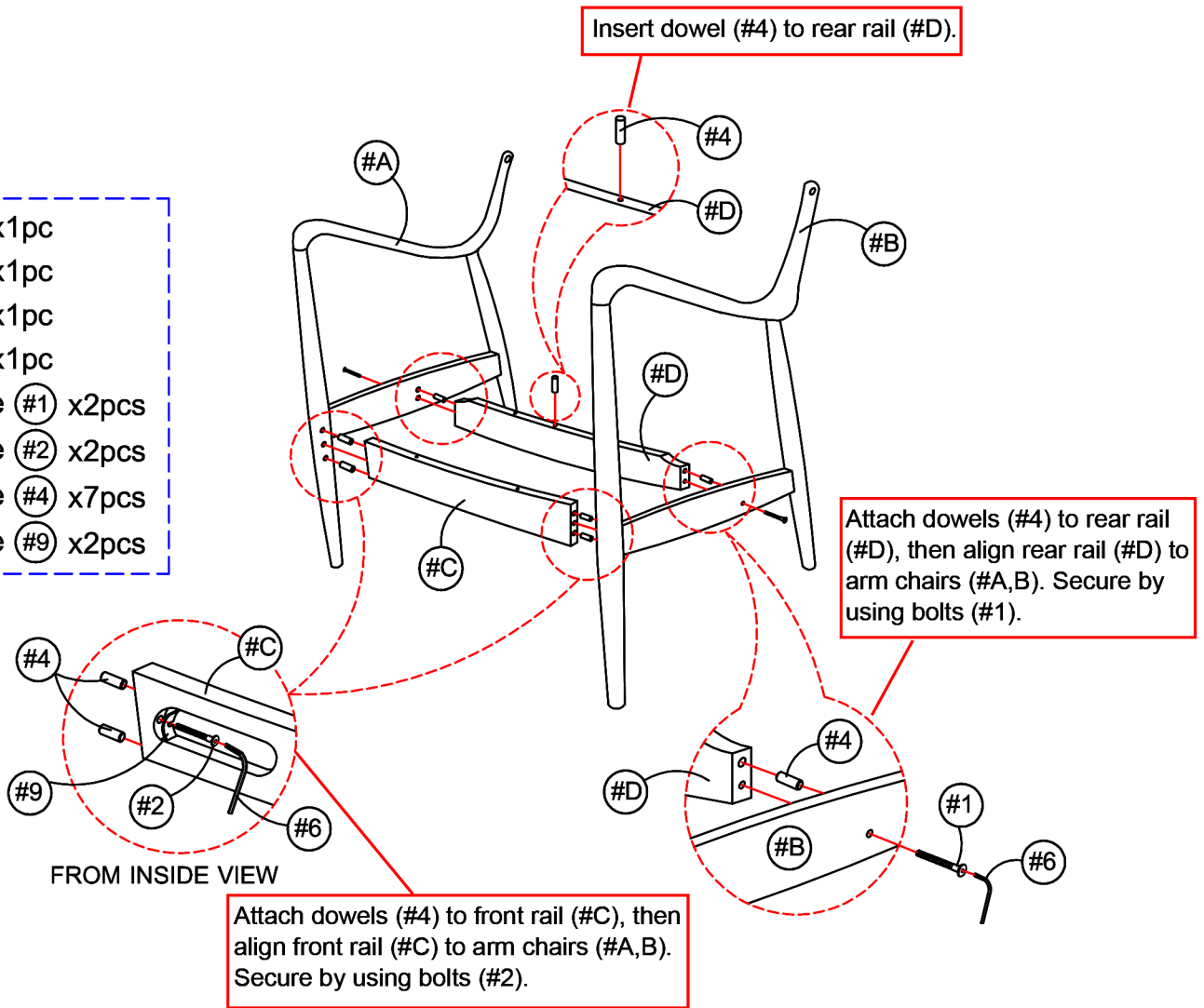

2

- Part (#E) x1pc
- Part (#F) x1pc
- Hardware (#2) x3pcs
- Hardware (#7) x3pcs
- Hardware (#8) x3pcs

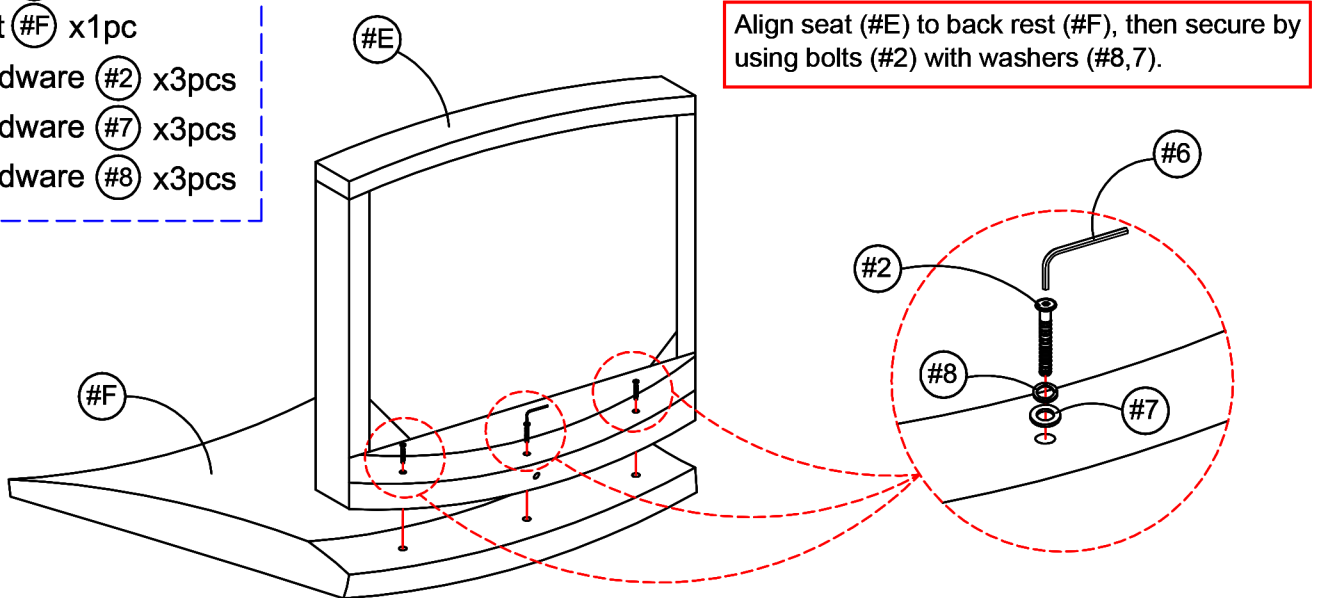

ASSEMBLY INSTRUCTIONS

Align chair to chair frame, then secure back rest to chair arms by using bolts (#2).

3

Hardware (#2) x2pcs
Hardware (#3) x4pcs

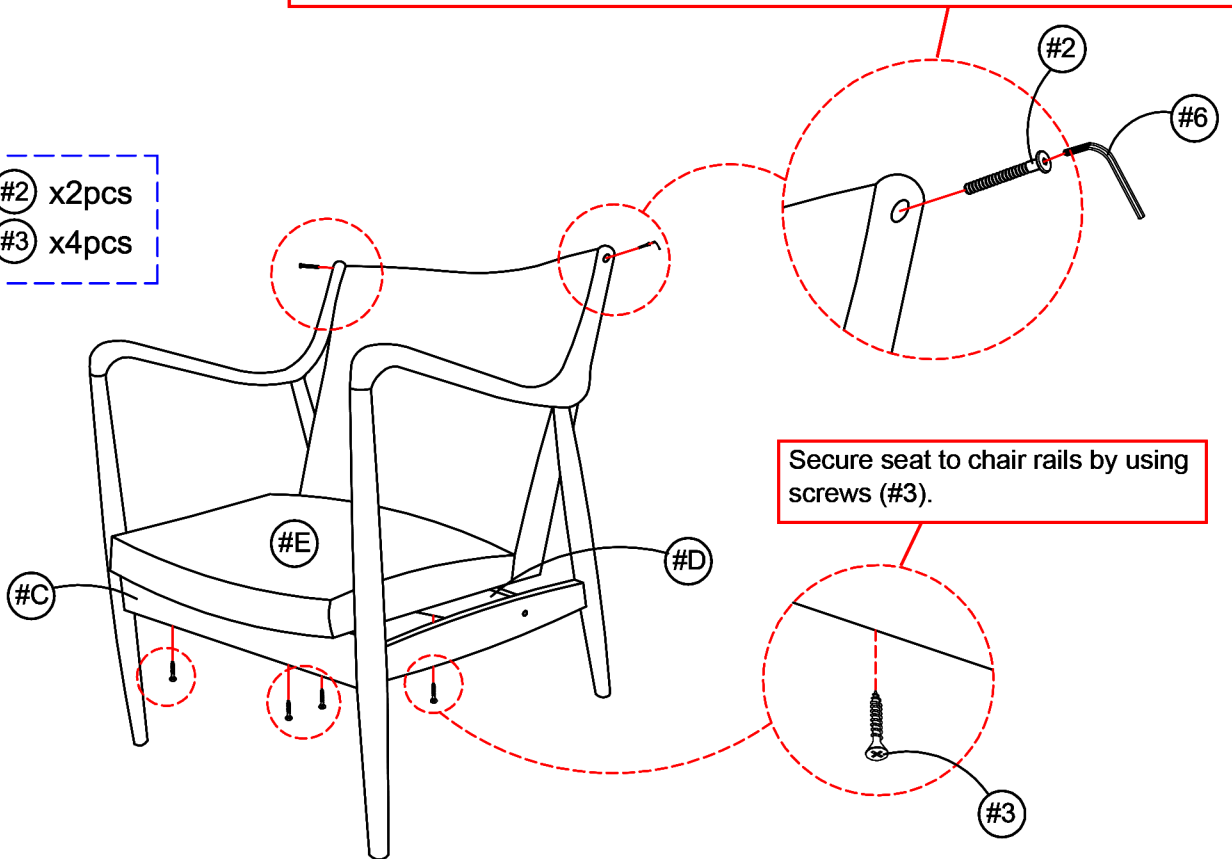

Secure seat to chair rails by using screws (#3).

4

Attach covers (#5) to bolt holes.

Part (#G) x1pc
Hardware (#5) x4pcs

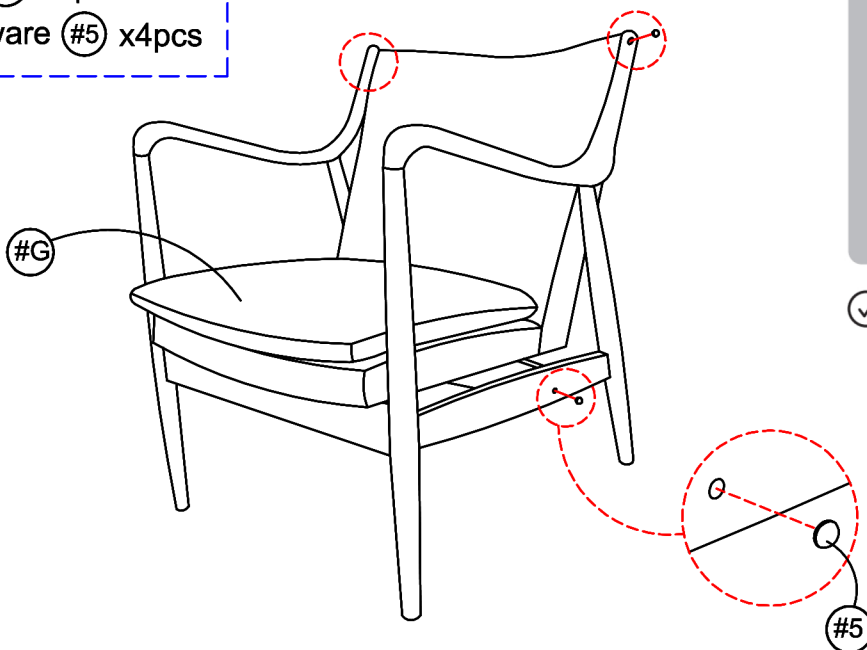

ASSEMBLY COMPLETED



Please ensure the furniture rests on an even and flat surface. If the product wobbles or feels loose, double-check all bolts and/or screws are properly tightened and secured.



Keep this handy!

Please retain this instruction manual and any order-related information for future reference.