

Assembly Instructions

Your chair comes packaged in one box. Carefully remove all of components from the packaging and set aside for assembly.

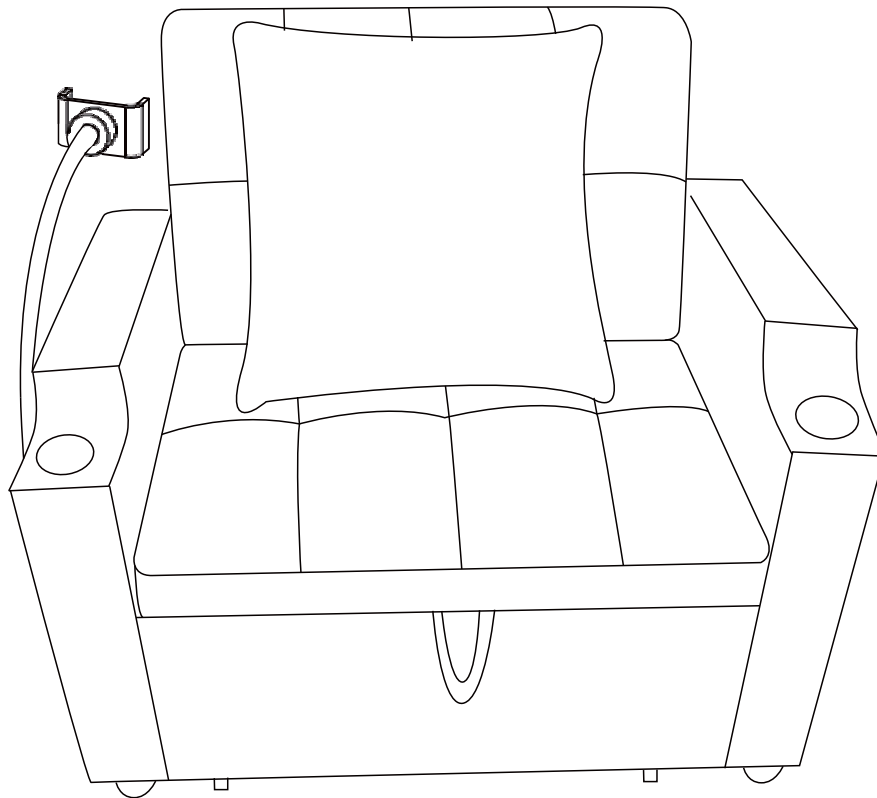

CAUTION:
DO NOT use any sharp objects
to open plastic wrapped
components as damage to
product or components may
result.





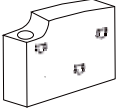
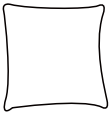

ASSEMBLY INSTRUCTIONS

HARDWARE LIST

PARTS LIST

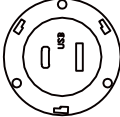
PART	DRAWING	DESCRIPTION	QTY
A		Seat frame	1
B		Arm (L&R)	2
C		Pillow	1
D		LEG	8

PART	DRAWING	DESCRIPTION	QTY
E		Roller	4
F		Screwdriver	1
G		Self-tapping	8
H		USB interface	1
I		Fixed movable support	1

ASSEMBLY INSTRUCTIONS

STEP 1

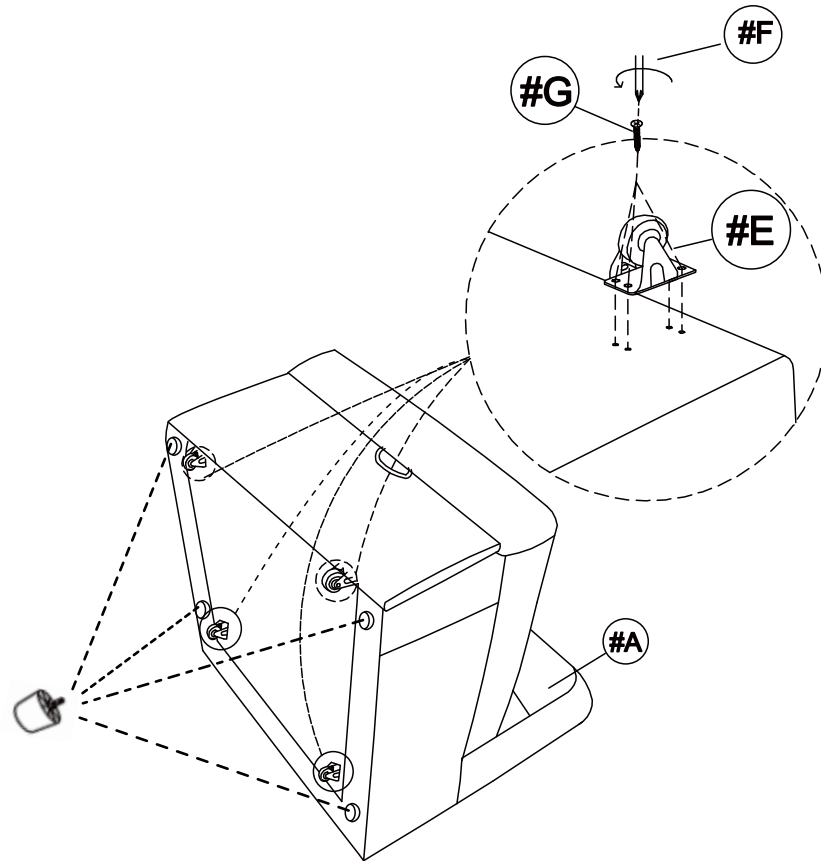

STEP 2

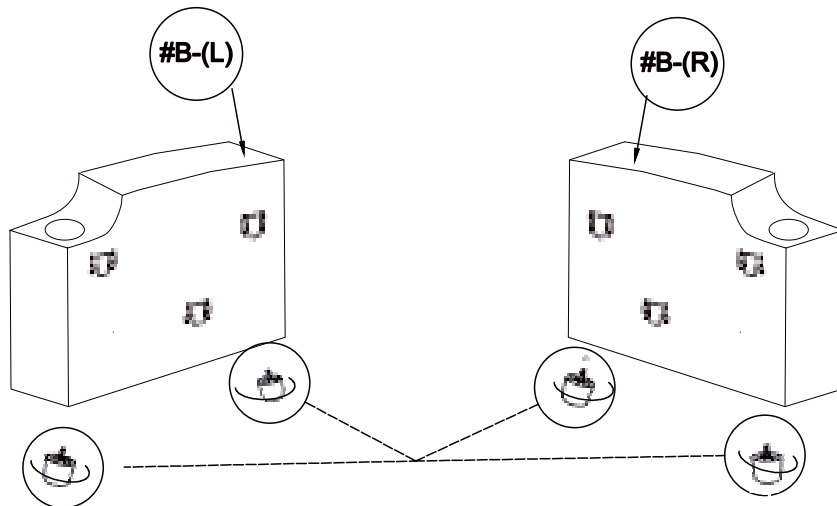

ASSEMBLY INSTRUCTIONS

STEP 3

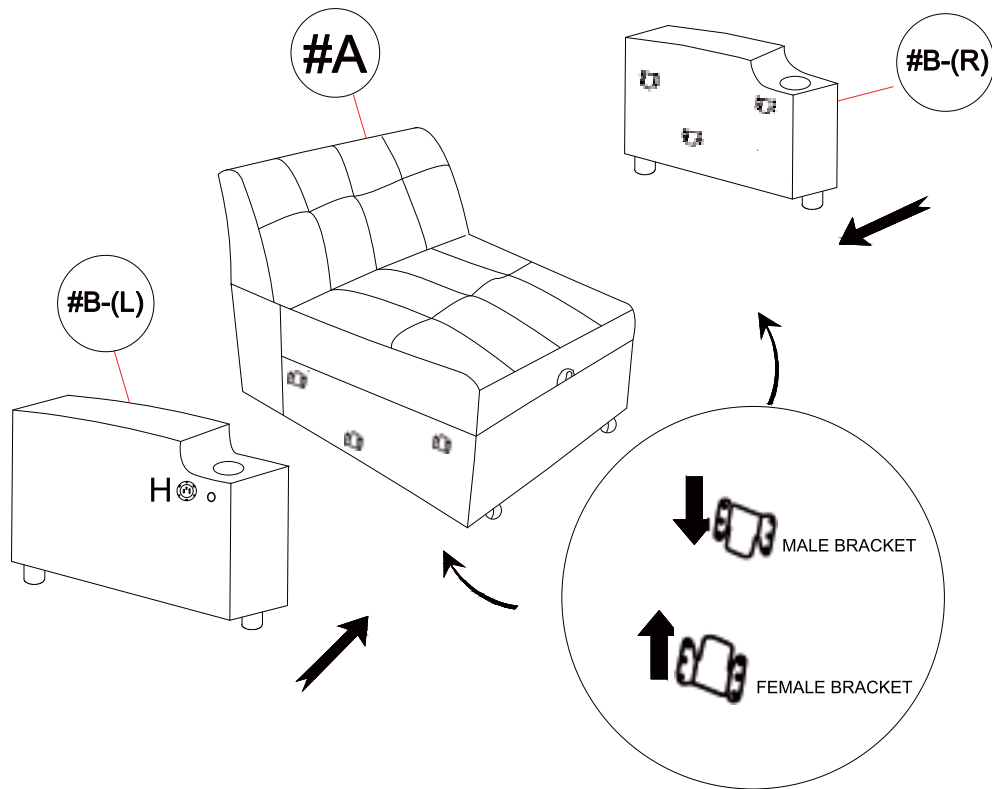

STEP 4

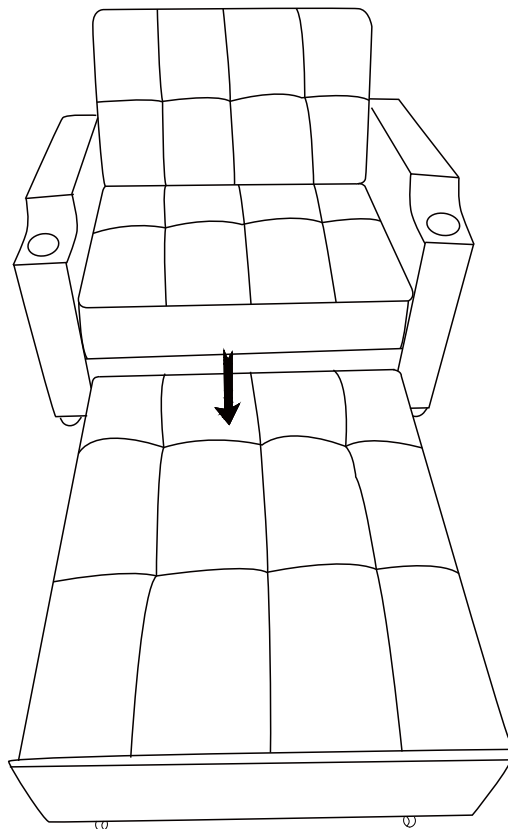

ASSEMBLY INSTRUCTIONS

STEP 5

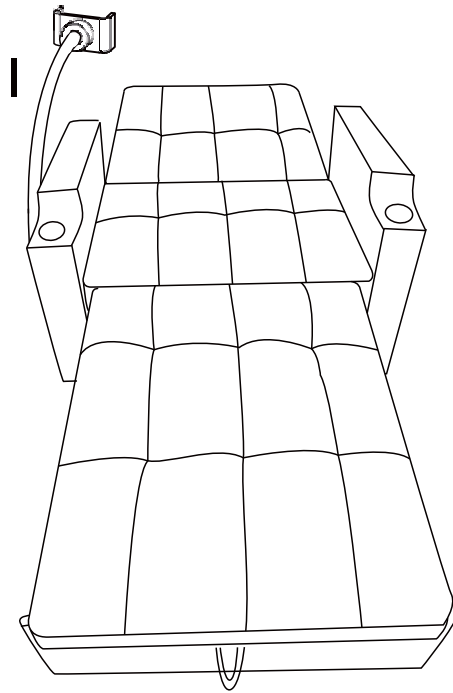

COMPLETED !

