

MODEL: WF-W-971-K

## Assembly Instruction

**TIPS: Before installation, please read the assembly instructions carefully.**

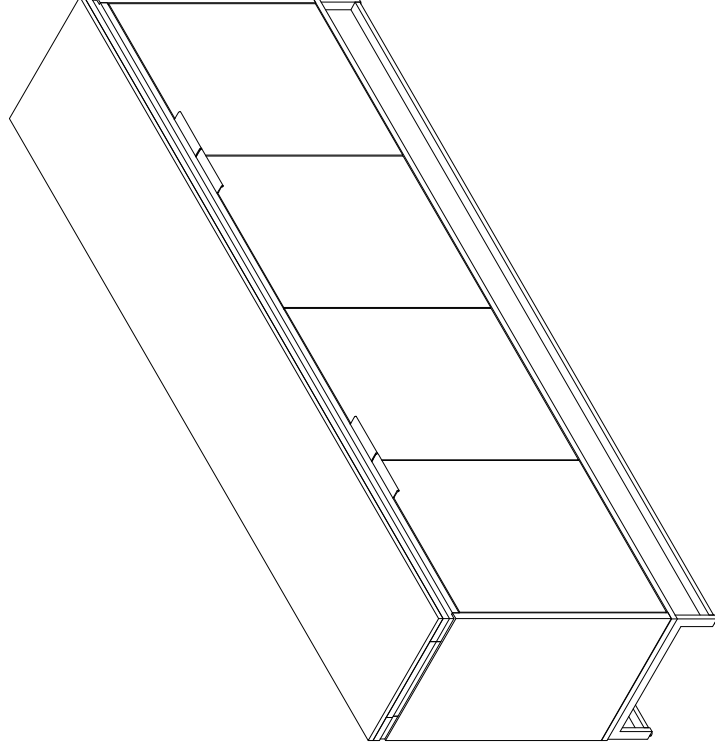



Clihome:  
[service@ali puinc.com](mailto:service@ali puinc.com)  
Browsing our website will bring you more surprises.  
<https://clihome.net/>  
303-747-4421

# Assembly Instruction

MODEL: WF-W-971-K

EDITION: A

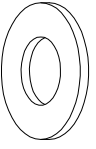
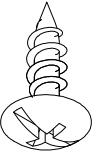
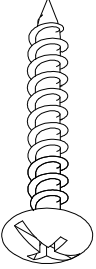
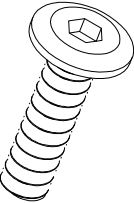

## HARDWARE LIST:

LABEL	PICTURE	DESCRIPTION	QTY
A		ALLEN KEY (φ4)	1PC
B		SCREW (M6*10)	16PCS
C		WASHER (φ16-φ6*1.5)	24PCS
D		SCREW (M6*12)	5PCS
E		SCREW (M6*40)	5PCS
F		SCREW (M6*16)	8PCS

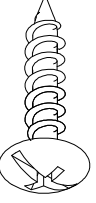
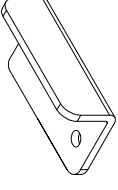
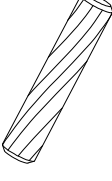
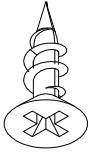
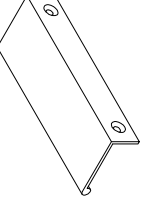
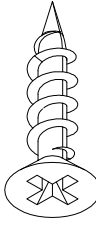
## HARDWARE LIST:

LABEL	PICTURE	DESCRIPTION	QTY
G		SCREW (M6*16)	4PCS
H		DOOR STOP (30*14*8)	2PCS
I		WOOD PLUG (φ8*40)	20PCS
J		SCREW (M6.5*12)	8PCS
K		HANDLE (120*41*20)	4PCS
L		SCREW (M6*16)	48PCS

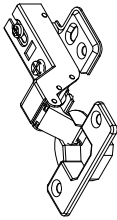
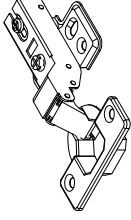
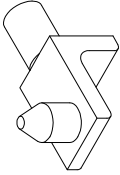
**HARDWARE LIST:**

LABEL	PICTURE	DESCRIPTION	QTY
M		INNER MASK HINGE (φ35-MAX)	4PCS
N		HALF OVERLAY HINGE (φ35-MIN)	4PCS
O		SHELF SUPPORT (26*16*9)	16PCS
P		TIPPING RESTRAIN	2PCS

**HARDWARE LIST:**

LABEL	PICTURE	DESCRIPTION	QTY

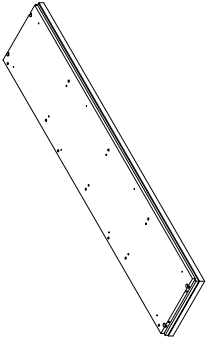
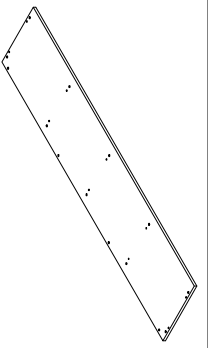
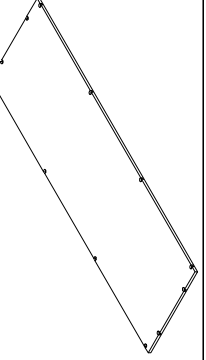
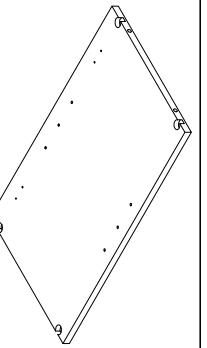
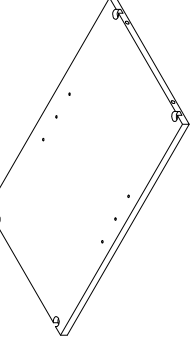

PART LIST:

LABEL	PICTURE	DESCRIPTION	QTY
1		TOP PANEL	1PC
2		BOTTOM PANEL	1PC
3		BACK PANEL	1PC
4		MIDDLE SIDE PANEL	1PC
5		LEFT&RIGHT MIDDLE SIDE PANEL	2PCS

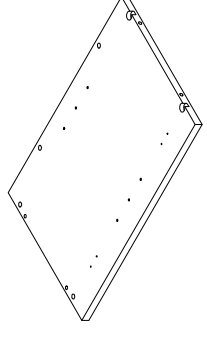
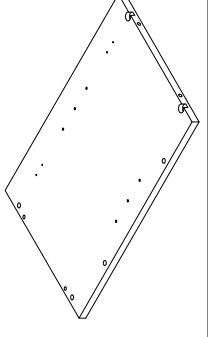
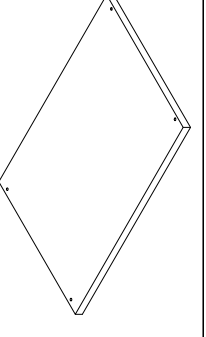
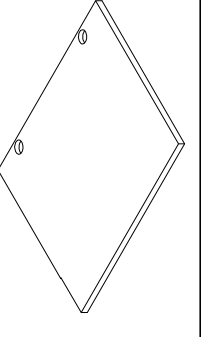
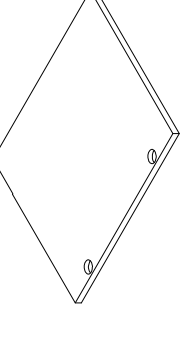
PART LIST:

LABEL	PICTURE	DESCRIPTION	QTY
6		LEFT SIDE PANEL	1PC
7		RIGHT SIDE PANEL	1PC
8		ADJUSTABLE SHELF	4PCS
9		LEFT DOOR	2PCS
10		RIGHT DOOR	2PCS

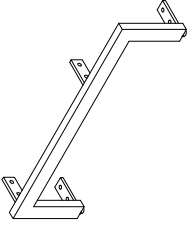
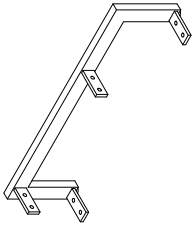
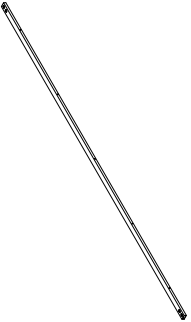
PART LIST:

LABEL	PICTURE	DESCRIPTION	QTY
11		LEFT SIDE FRAME	1PC
12		RIGHT SIDE FRAME	1PC
13		FRONT UP CONNECTING BAR	1PC
14		BACK UP CONNECTING BAR	1PC
15		BOTTOM CONNECTING BAR	2PCS

PART LIST:

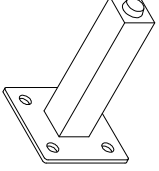
LABEL	PICTURE	DESCRIPTION	QTY
16		MIDDLE LEG	2PCS



# Assembly Instruction

EDITION: A

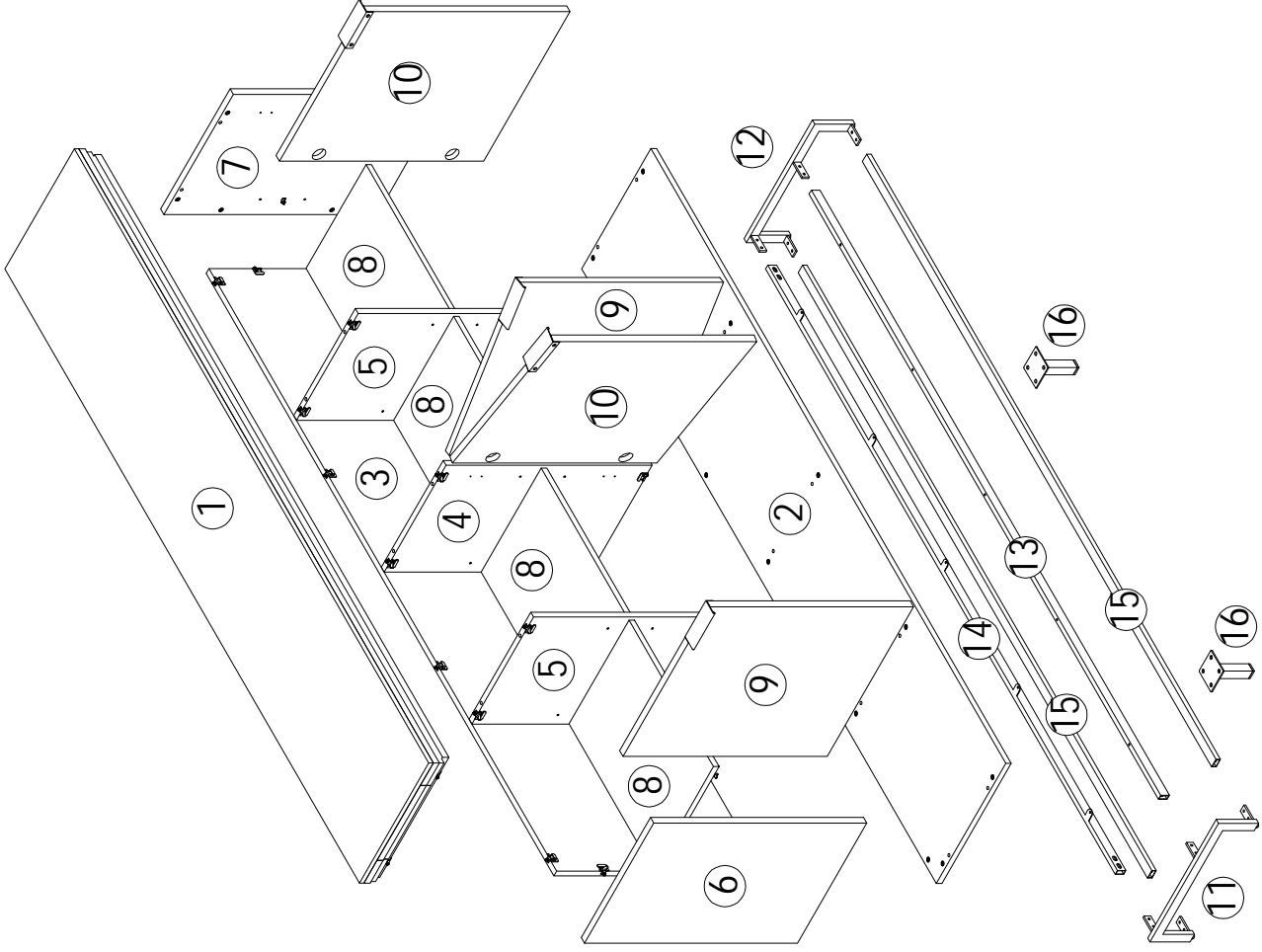
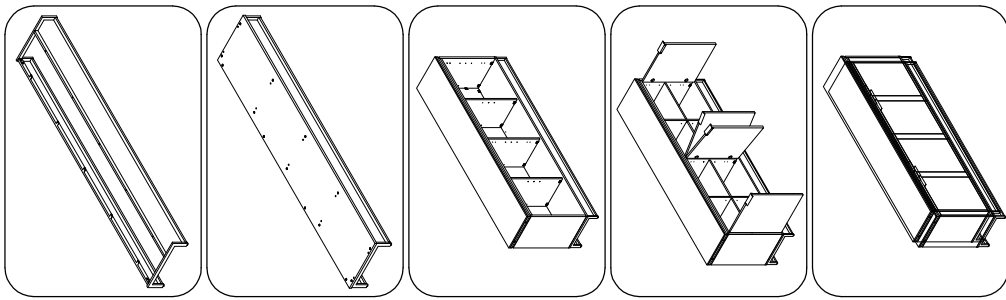

MODEL: WF-W-971-K

PART LIST:



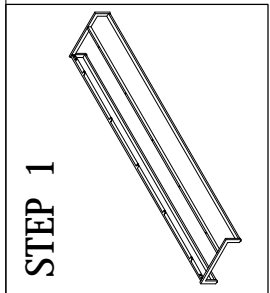
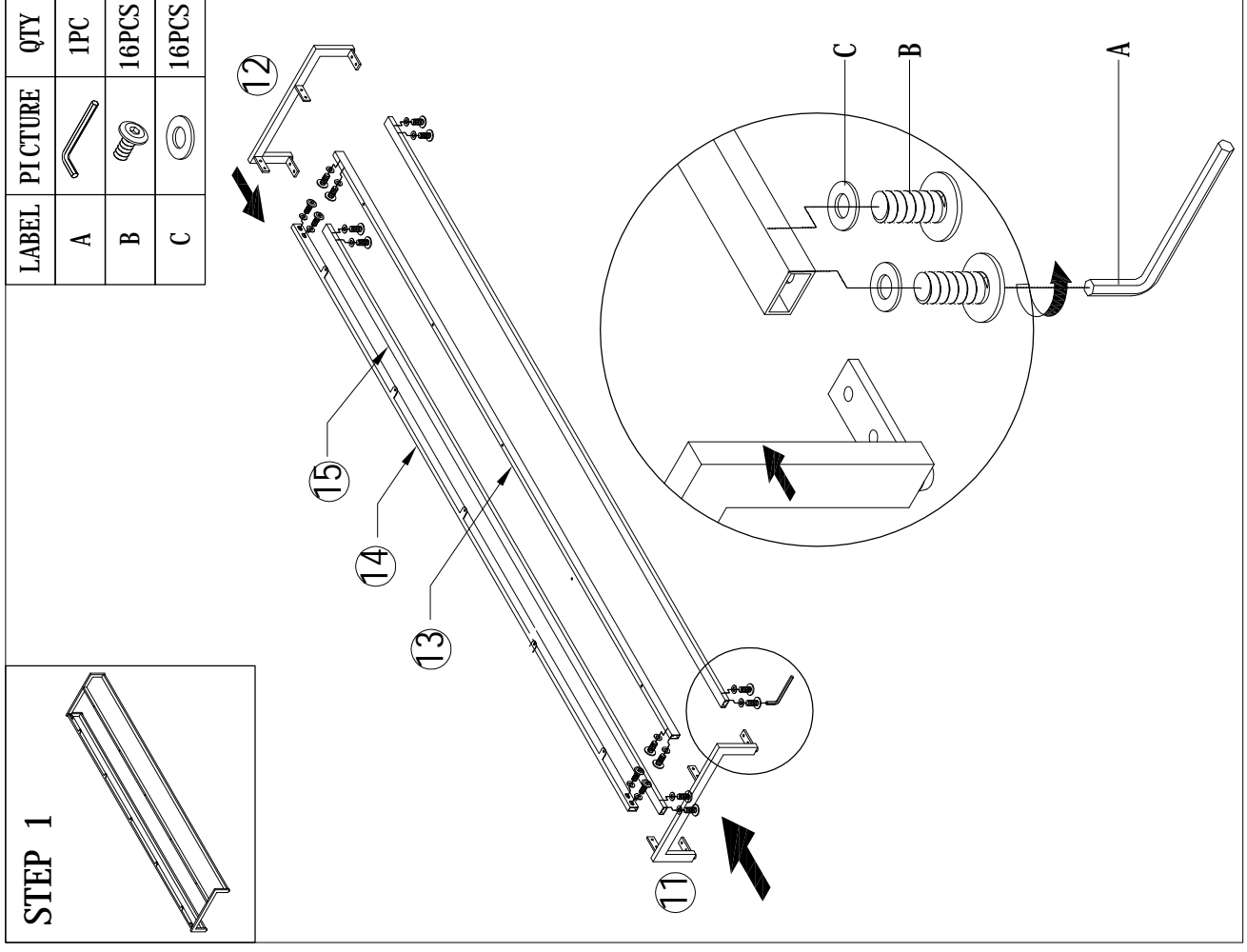

LABEL	PICTURE	QTY
A		1PC
B		16PCS
C		16PCS



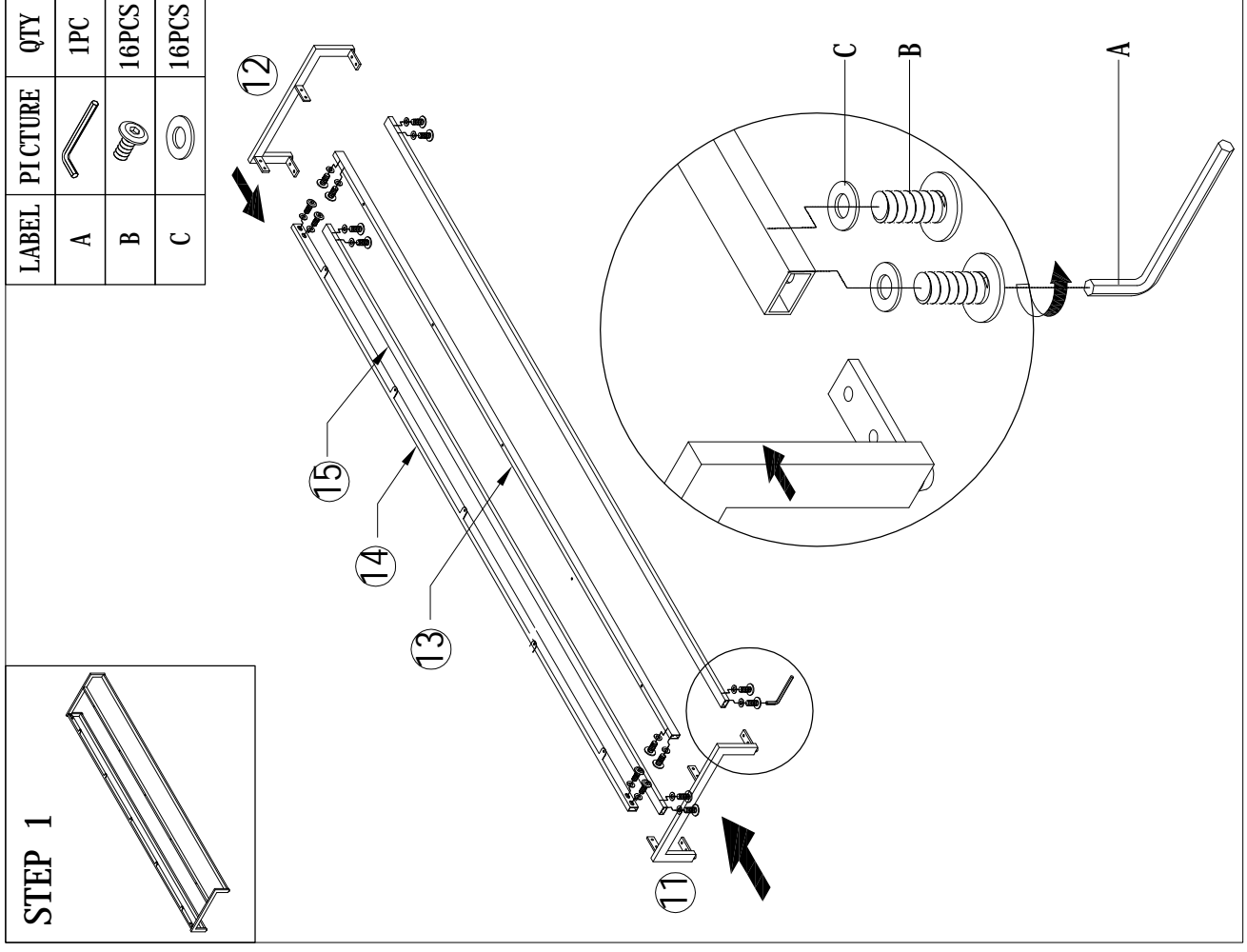
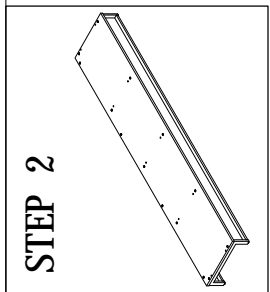

LABEL	PICTURE	QTY
D		5PCS
E		5PCS

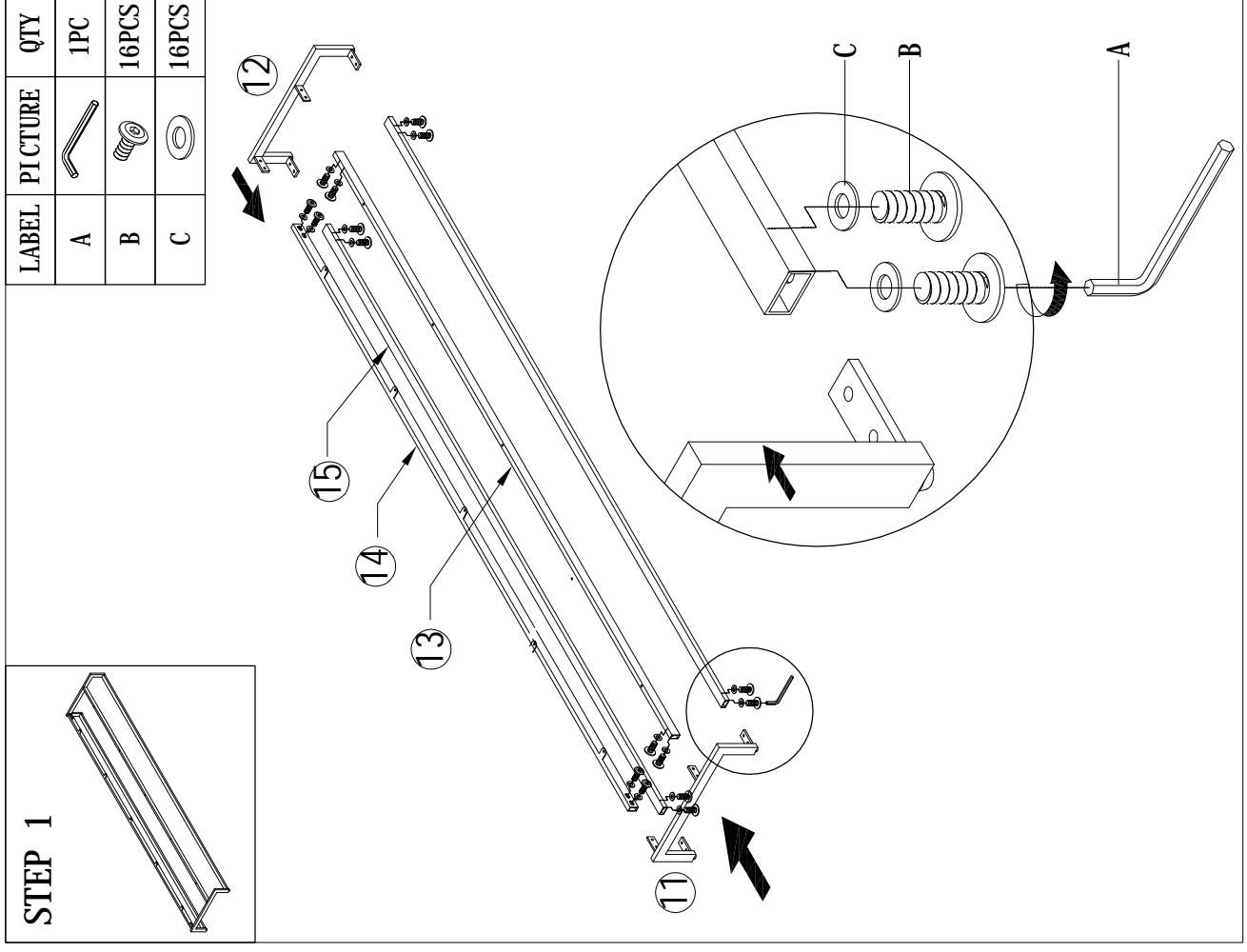
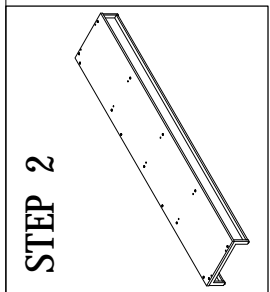

LABEL	PICTURE	QTY
D		5PCS
E		5PCS



LABEL	PICTURE	QTY
A		1PC
F		8PCS
C		8PCS

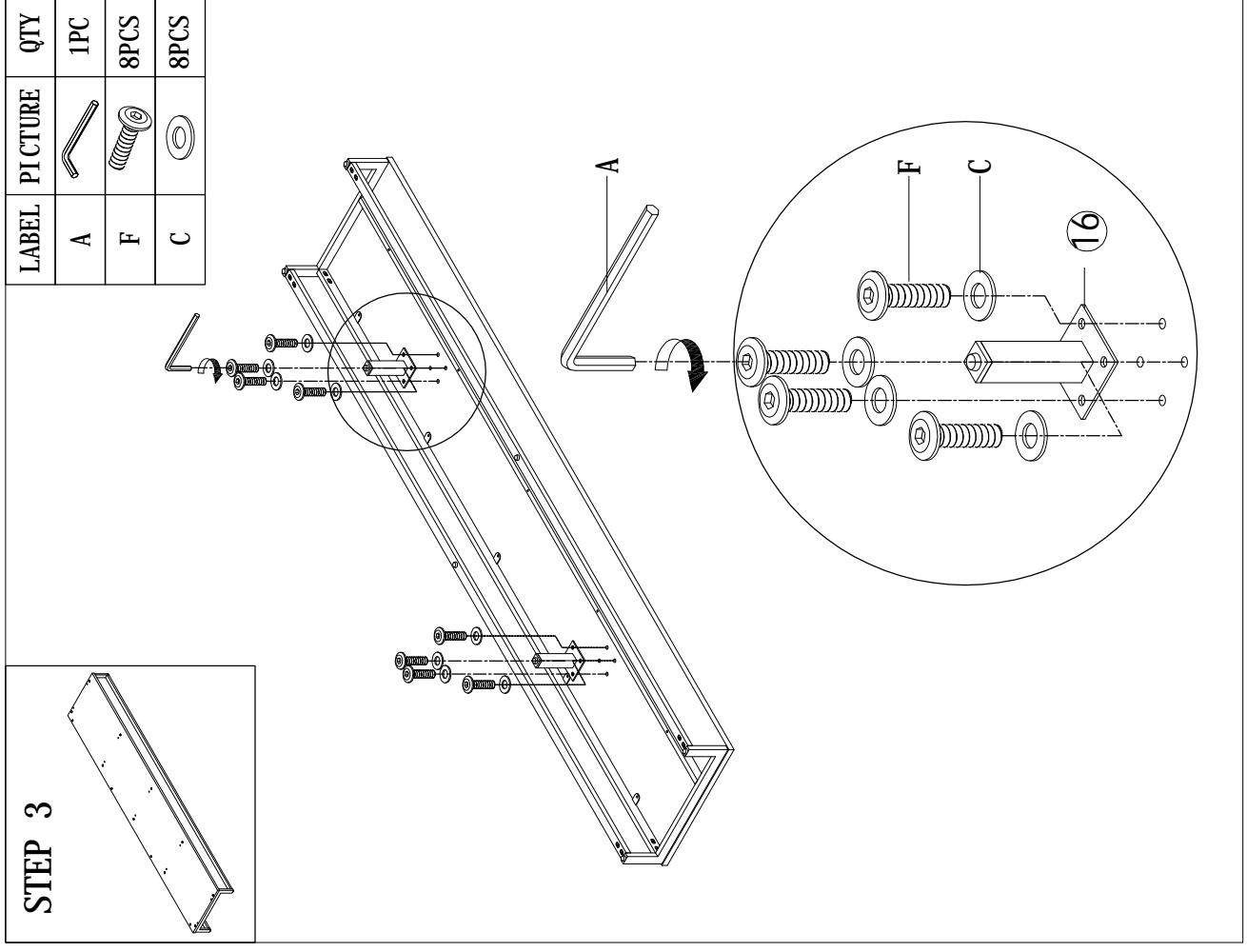

LABEL	PICTURE	QTY
I		10PCS

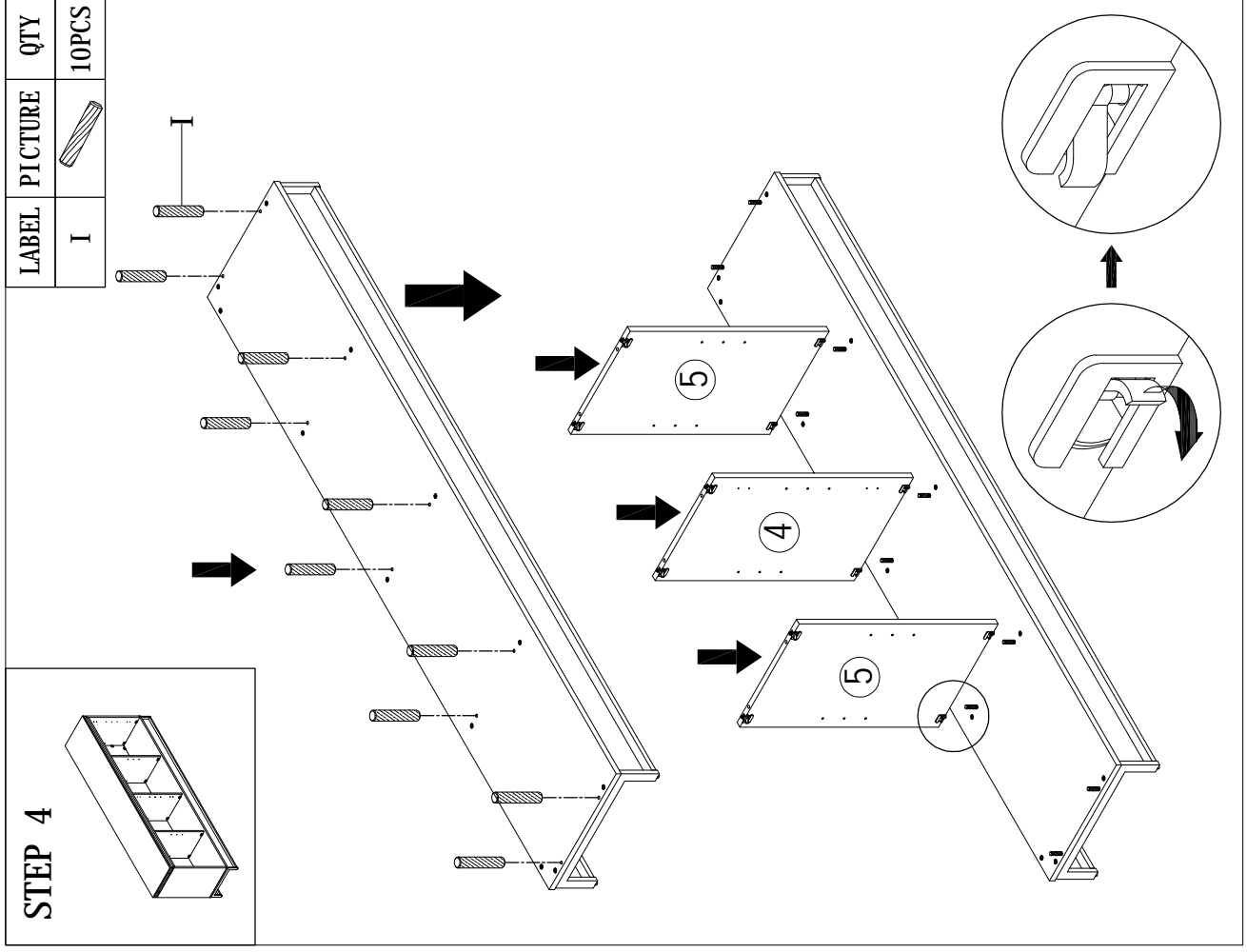



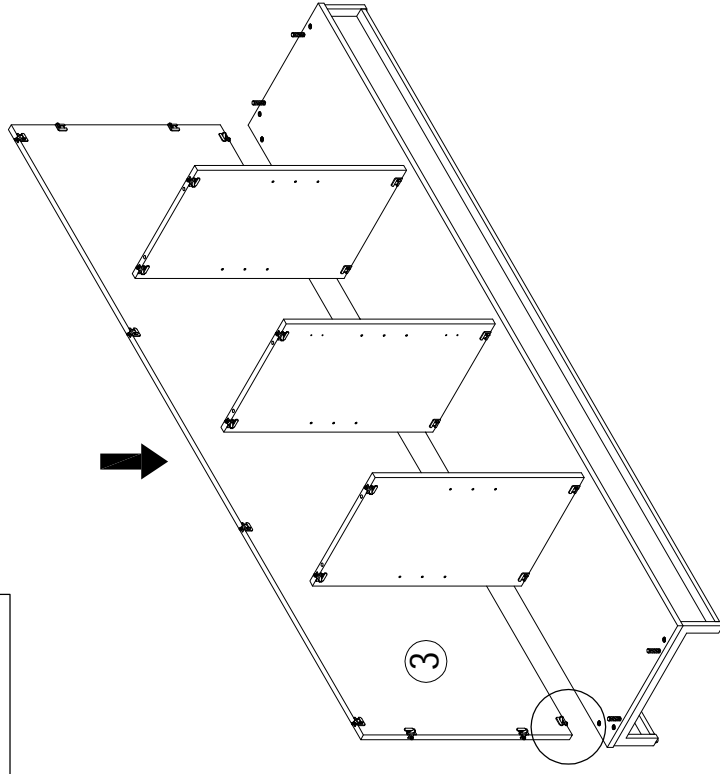
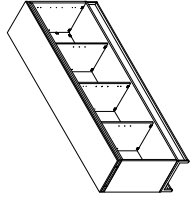

STEP 5



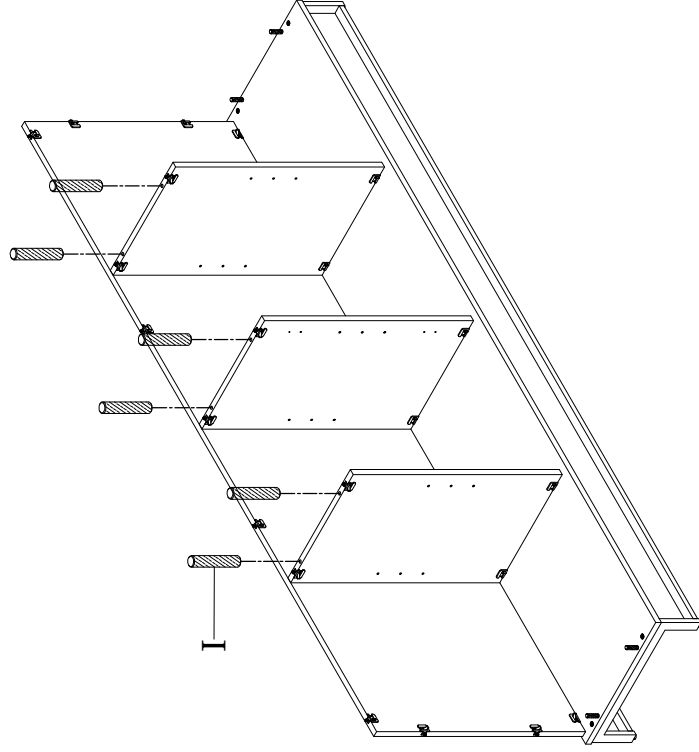
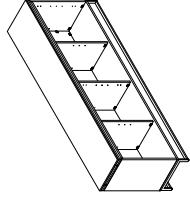

STEP 6

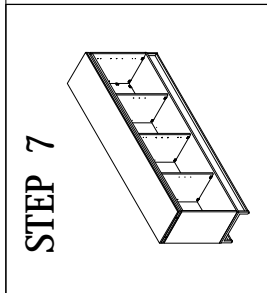

LABEL	PICTURE	QTY
I		6PCS



STEP 7

LABEL	PICTURE	QTY
G		4PCS
H		2PCS

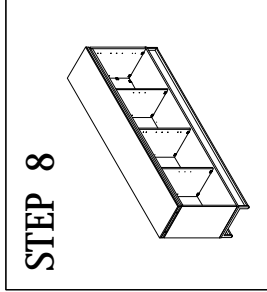
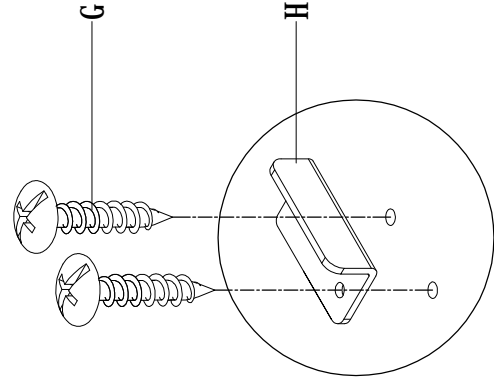
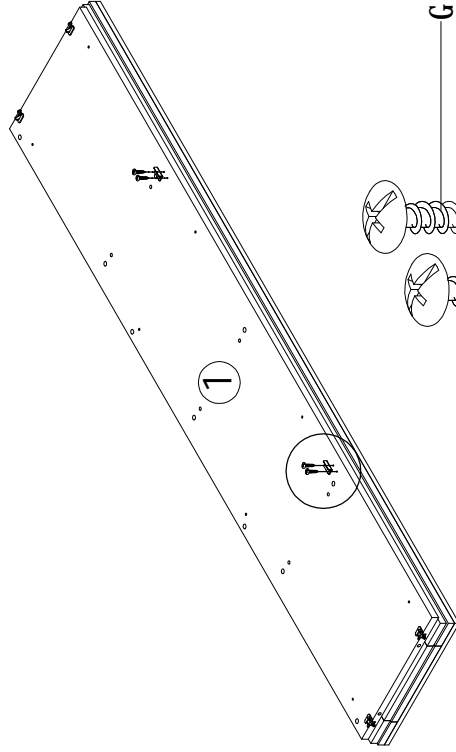

STEP 8

LABEL	PICTURE	QTY
I		4PCS

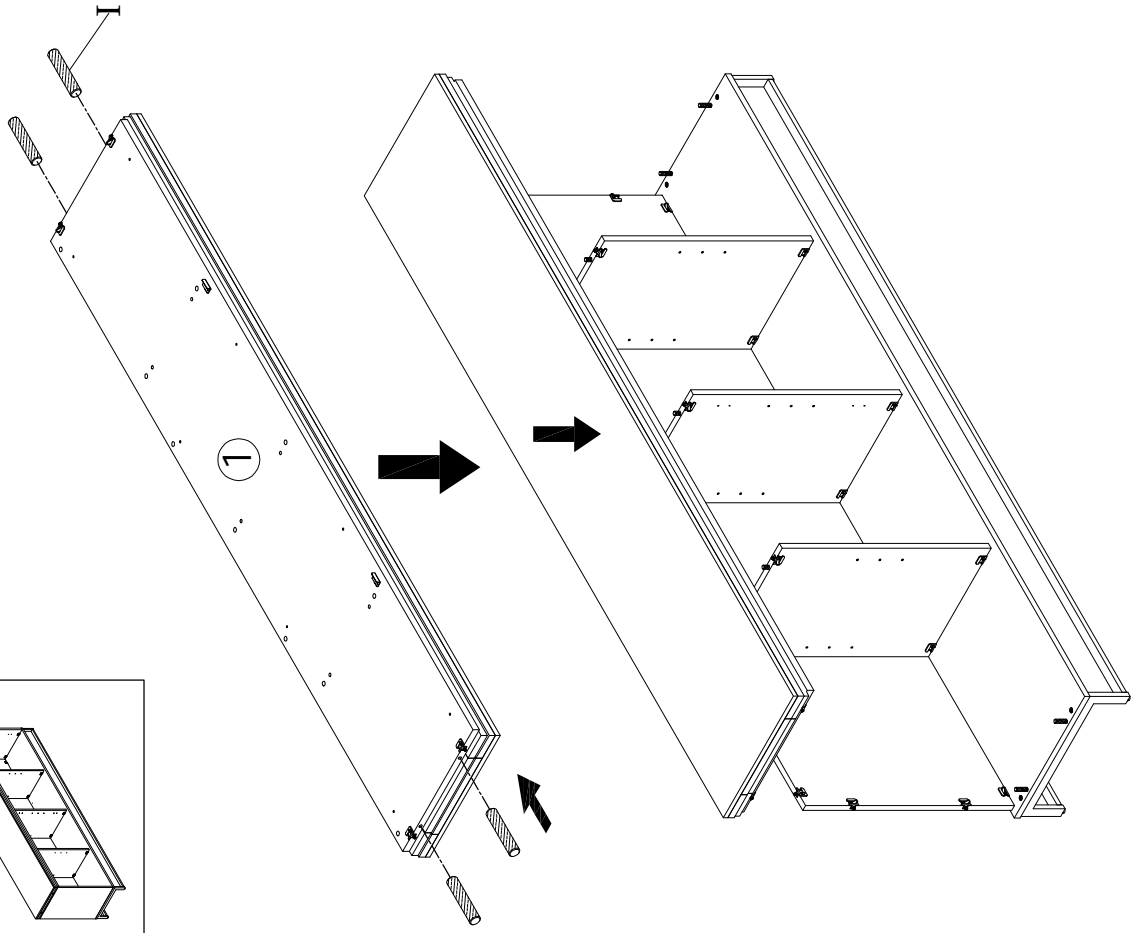

STEP 7

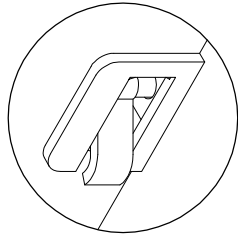
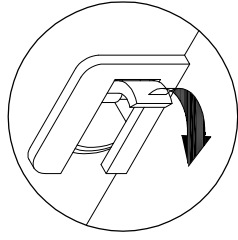
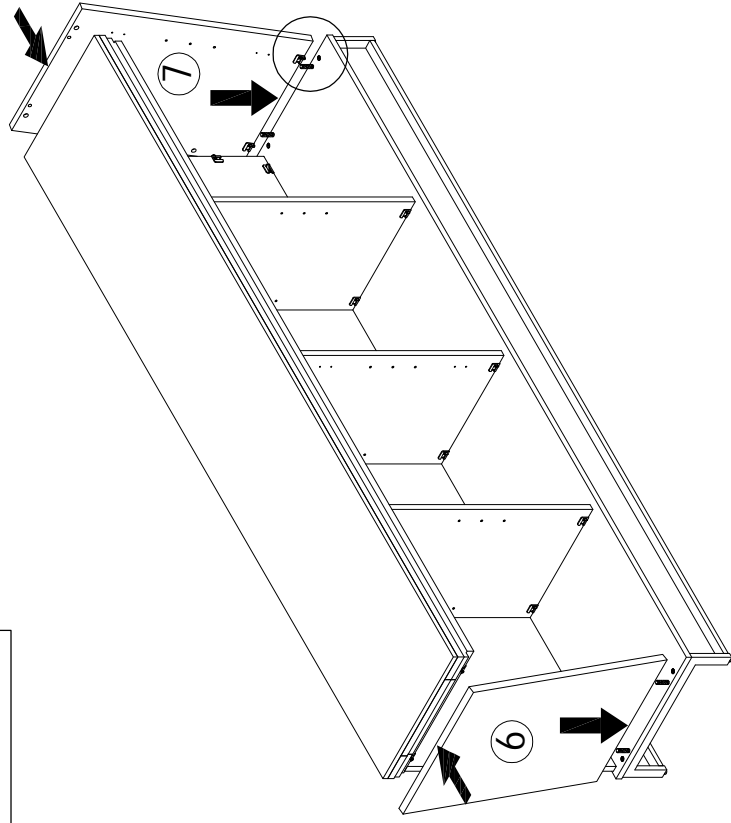
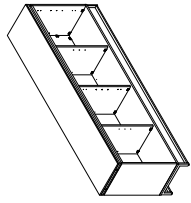

STEP 8

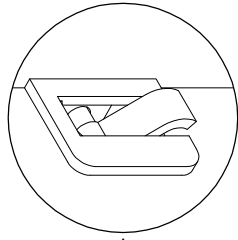
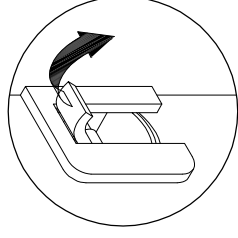
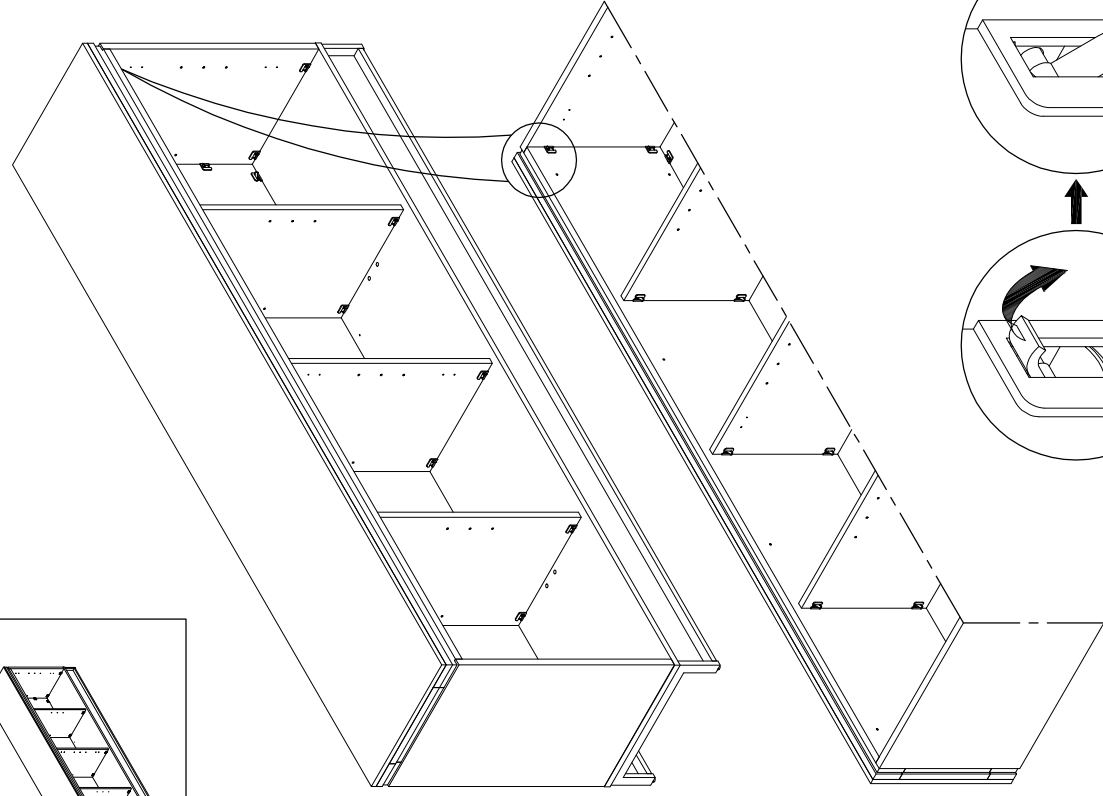
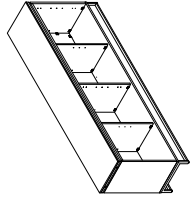

**STEP 9**

LABEL	PICTURE	QTY
J		8PCS
K		4PCS

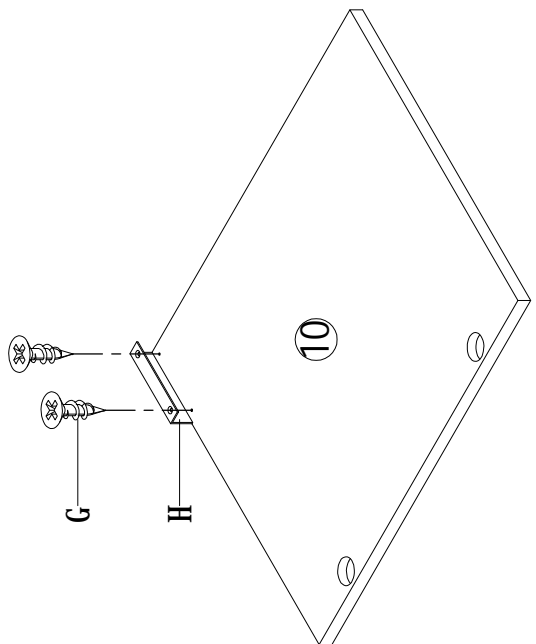
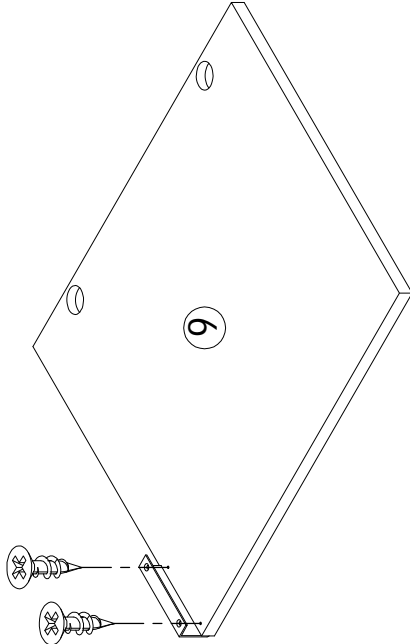

**STEP 10**

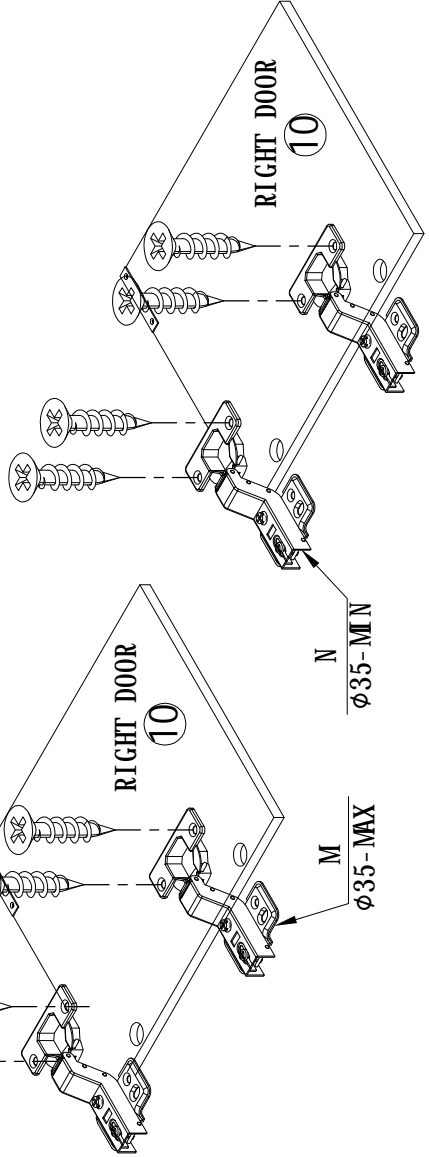
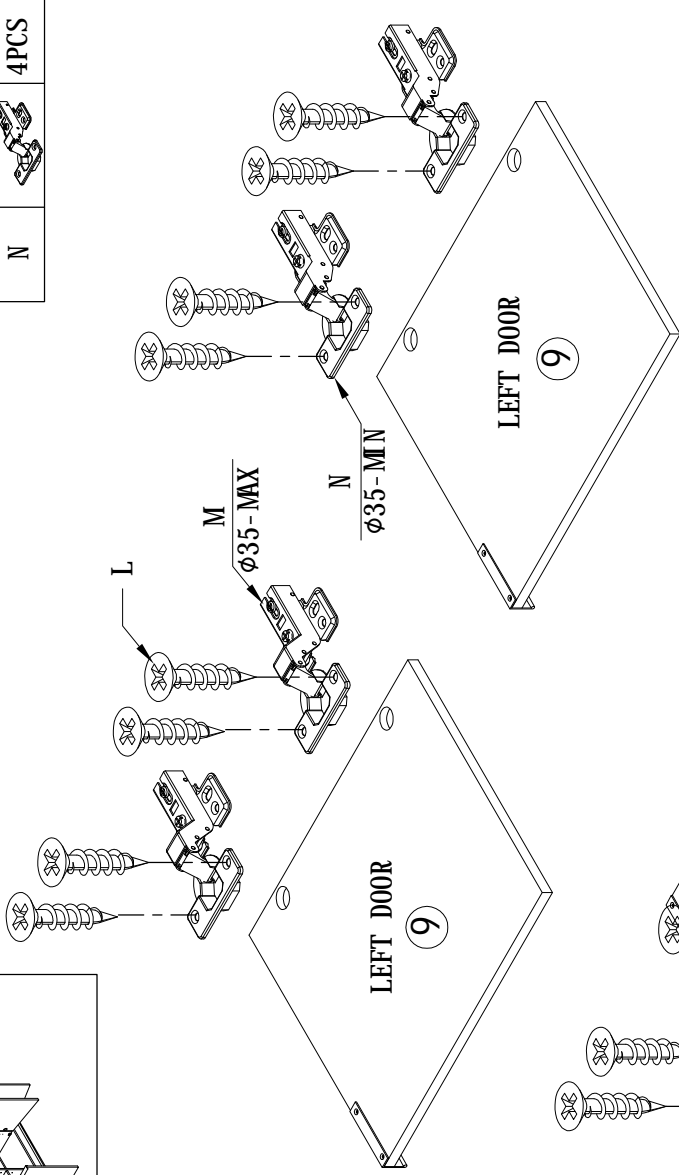

LABEL	PICTURE	QTY
L		16PCS
M		4PCS
N		4PCS

STEP 11

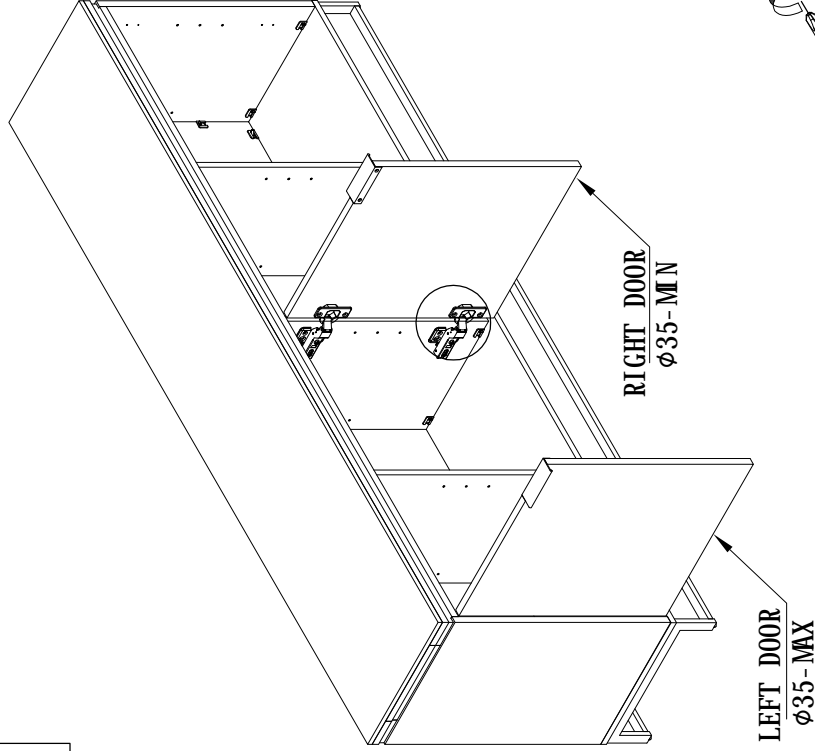
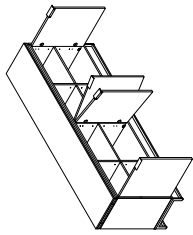

LABEL	PICTURE	QTY
L		16PCS

DOOR FITTING

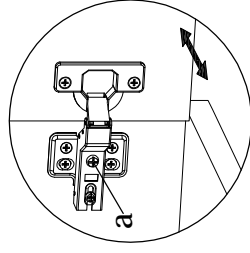

To adjust in width

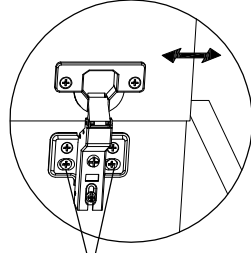

To adjust in height

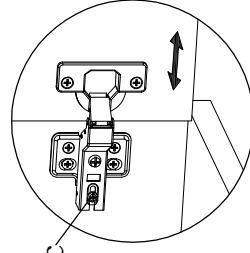

To adjust in depth

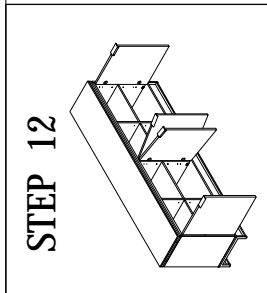

STEP 12

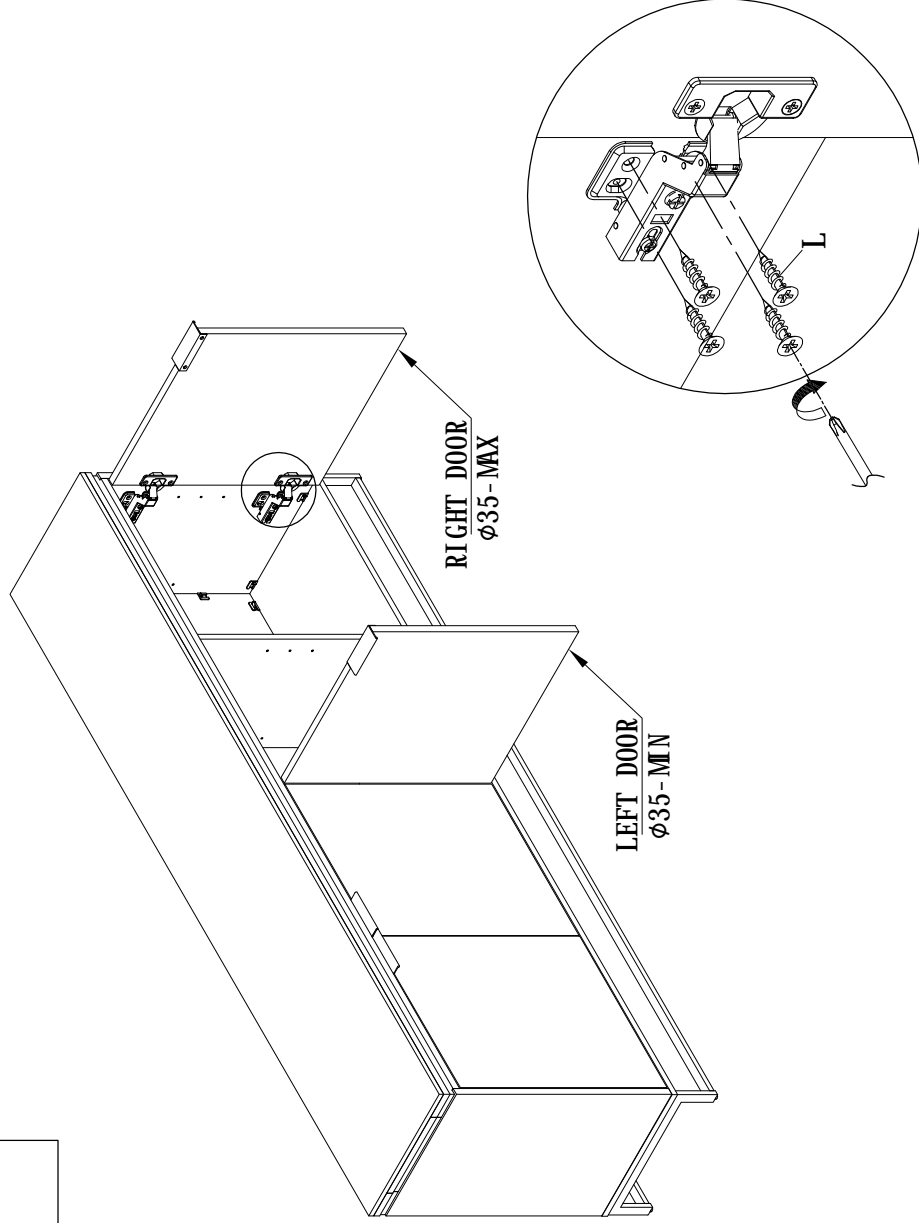

LABEL	PICTURE	QTY
L		16PCS

DOOR FITTING
<p>To adjust in width</p>
<p>To adjust in height</p>
<p>To adjust in depth</p>

STEP 13

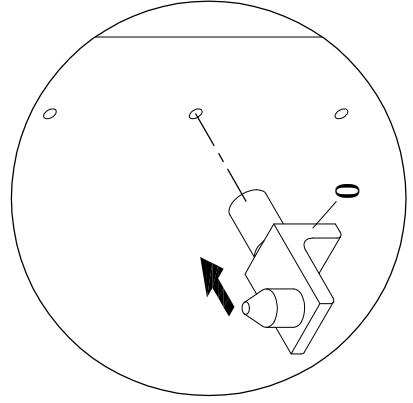
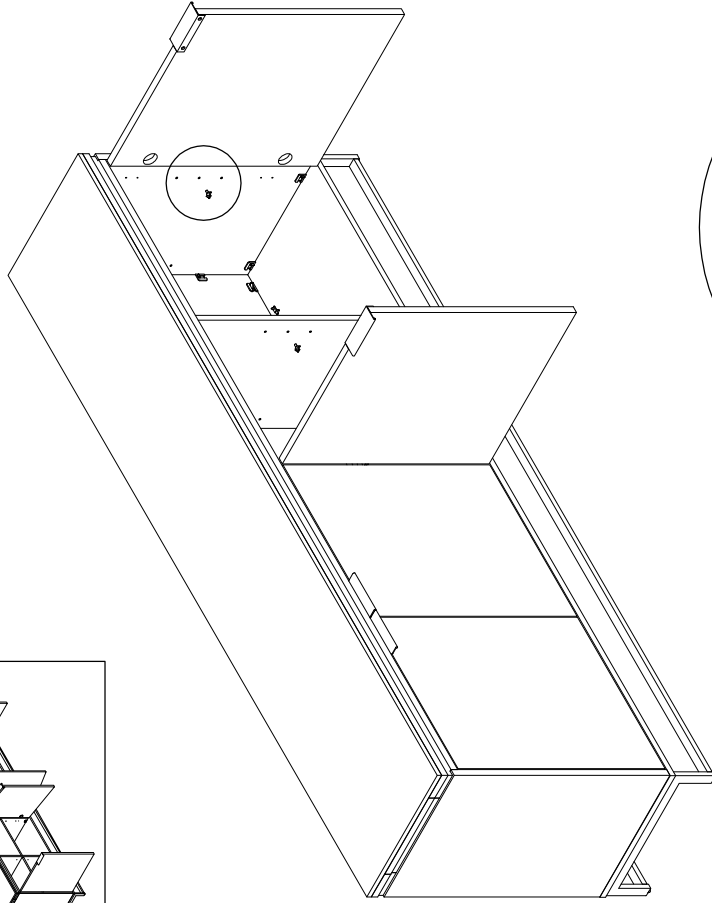
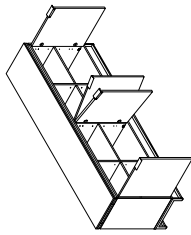

LABEL

0

PICTURE



QTY

8PCS

STEP 14

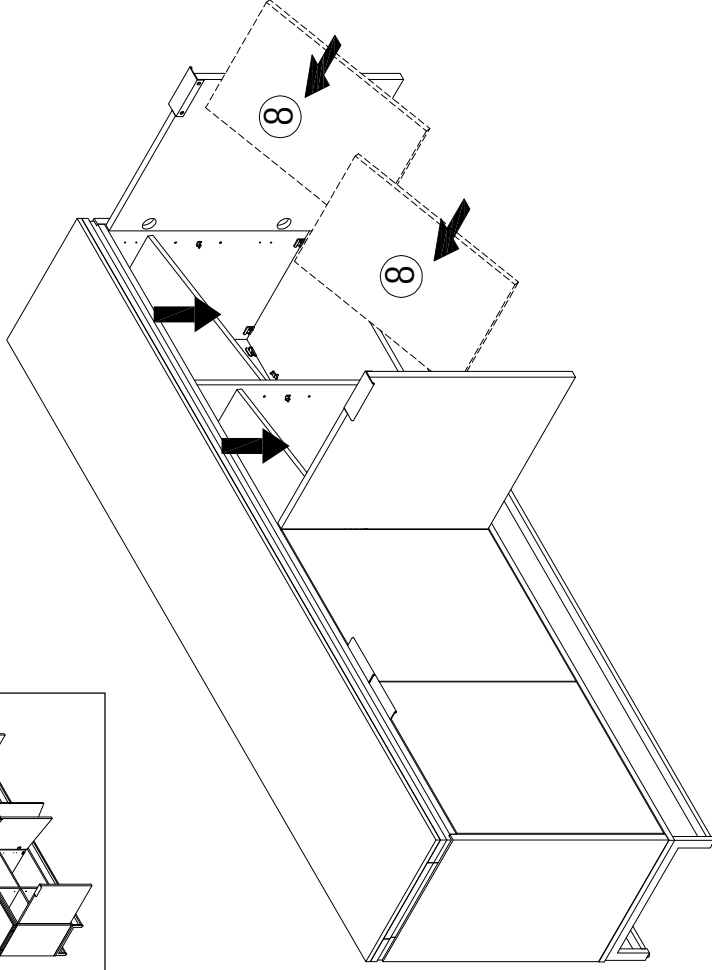
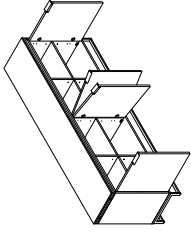

STEP 13

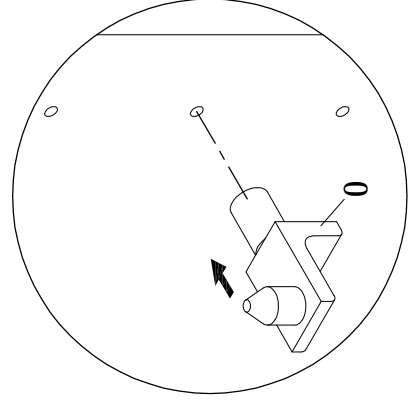
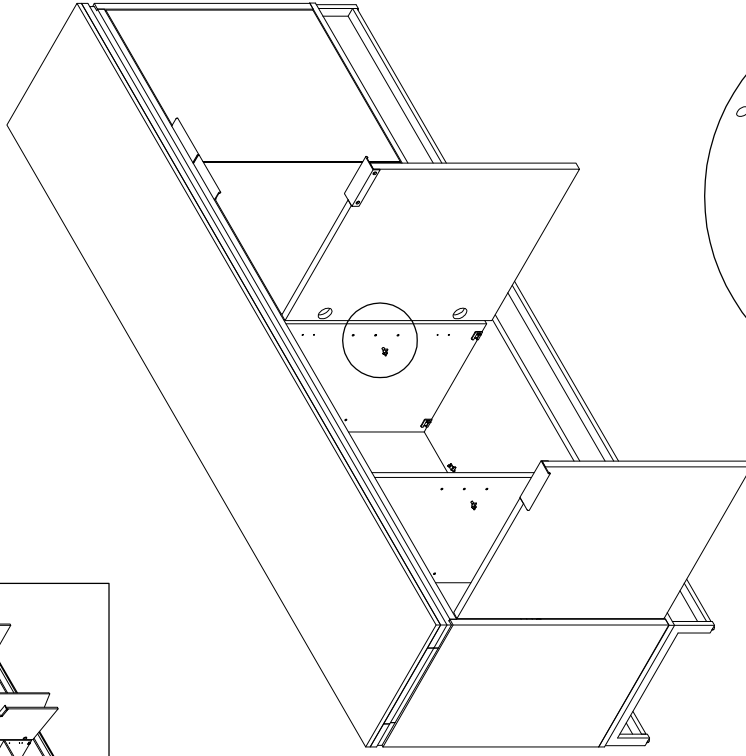
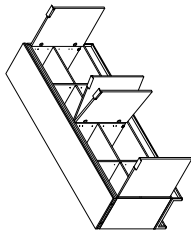

LABEL

0

PICTURE



QTY

8PCS

STEP 14

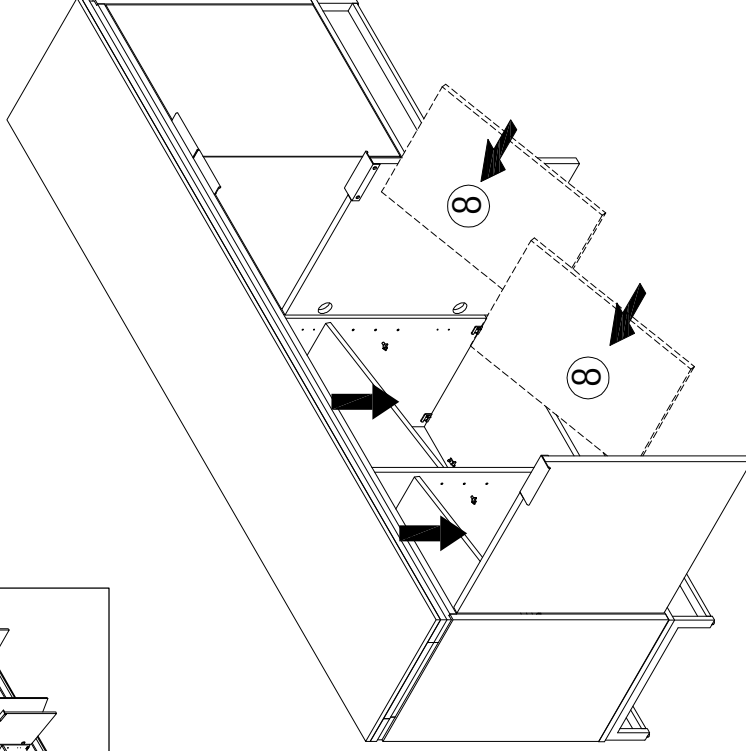
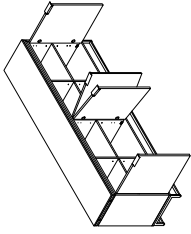



STEP 14

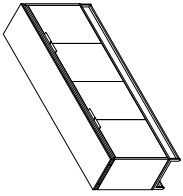

LABEL	PICTURE	QTY
P		2PCS

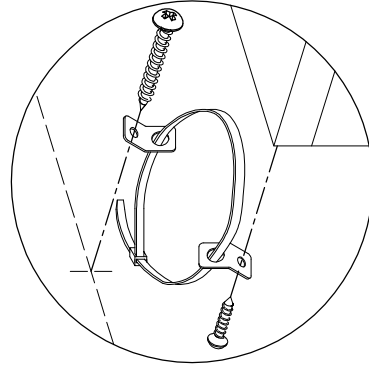
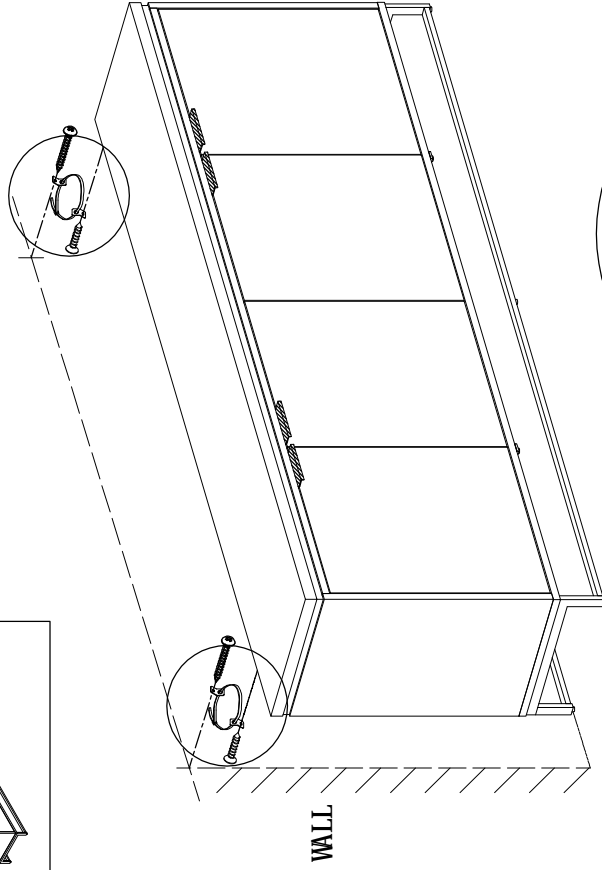

ANTI-TIP KIT INSTALLATION

STEP 15

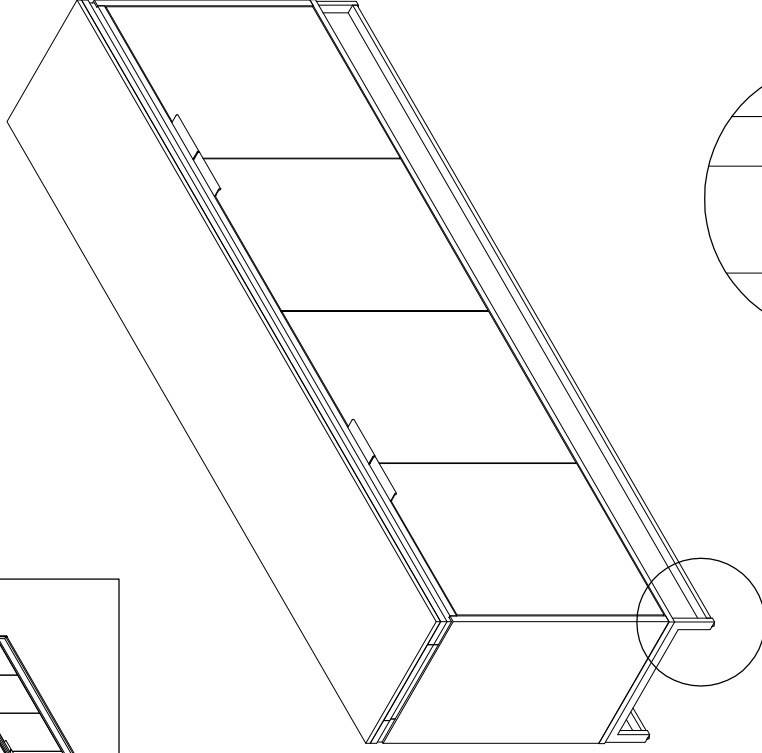
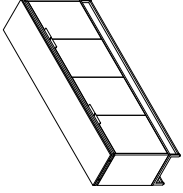

ADJUSTABLE LEVELERS

To ensure the unit is level on the floor, please use the adjustable leveler on the bottom of each leg.