

SELFIE RING LIGHT

USER MANUAL

Selfie Ring Light with Tripod Stand

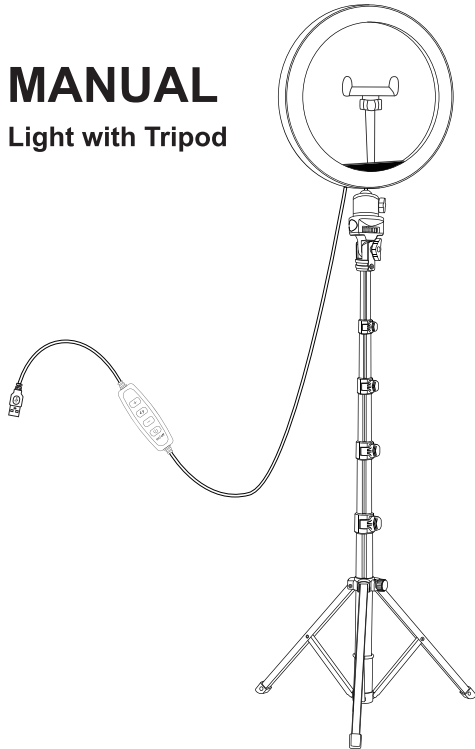

Input: DC 5.0V \approx 2000mA

Made in China

Thank you for purchasing the Selfie Ring Light.

Please read the instructions and warnings carefully before use to ensure your safety and satisfaction of this product.

Package Included

- ① Ring light x1
- ② Tripod ball head x1
- ③ Tripod x1
- ④ Mobile phone holder x1
- ⑤ Selfie remote control x1
- ⑥ Instruction manual x1

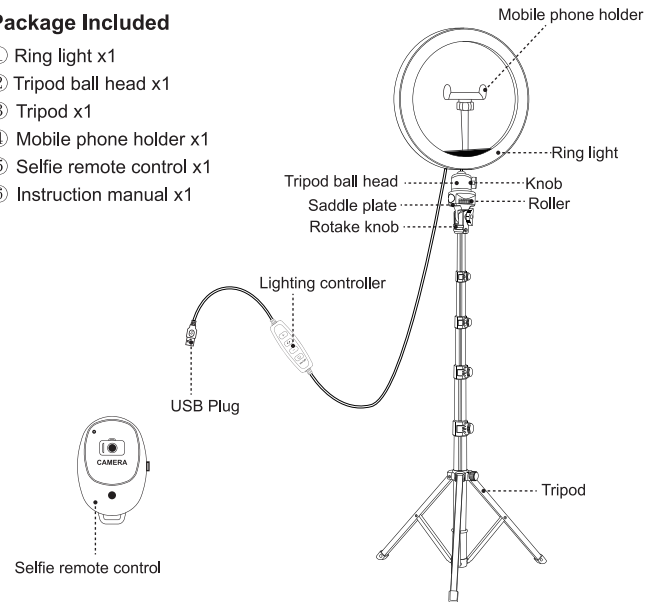

⚠ WARNING

- Do not use this product in a damp place.
- Prevent exposure to the sun.
- When not use for a long time, please unplug.

- 1 -

How to Install a Tripod

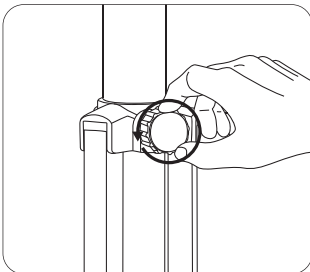

1. Unscrew the lowermost knob of the tripod counterclockwise.

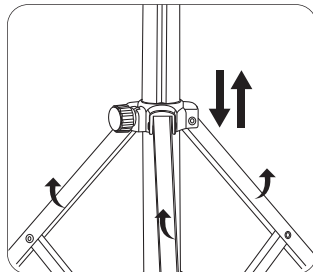

2. Pull the three legs of the tripod outward and move up and down.

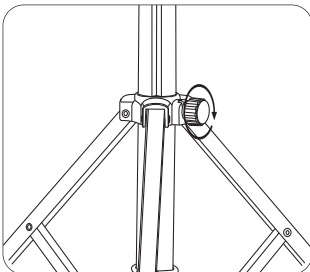

3. After adjusting the three legs of the tripod to a stable angle, turn the knob clockwise.

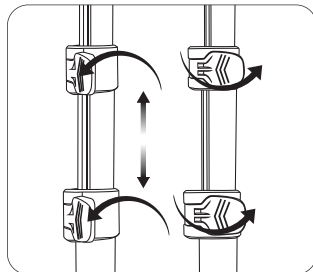

4. Extend the tripod stick from bottom to top by unlocking the lock catch, tighten the lock catch to fix the tripod stick at any desired height.

- 2 -

How to Install The Ring Light

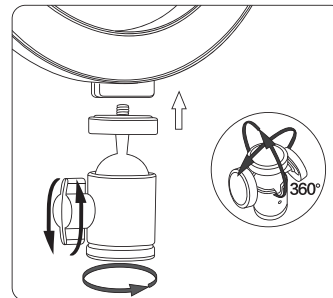

1. Insert the Tripod Ball Head into the screw hole of the ring light, screw the bottom of the Tripod Ball Head clockwise.

Note: Rotate the Tripod Ball Head, and the joint ball design allows the ring light to be adjusted to 360°. Then tighten the Tripod Ball Head.

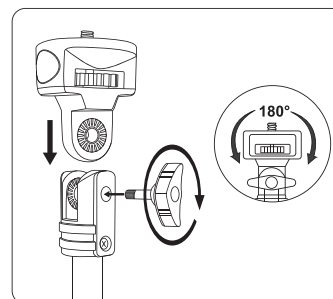

2. Adjust the saddle plate. Loosen the knob counterclockwise, rotate the saddle plate 90° upwards, and then tighten the knob clockwise.

Note: The saddle plate can be adjusted to 180°.

- 3 -

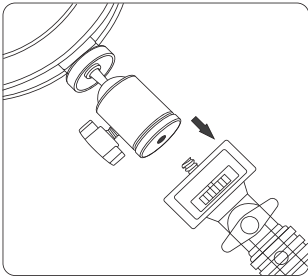

3. Assemble the ring light with the Tripod Ball Head on the saddle plate through the screw.

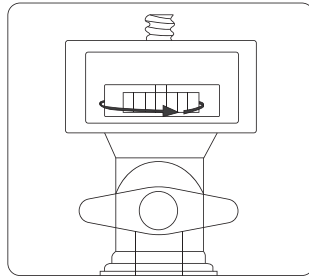

4. Tighten the roller of the saddle plate counterclockwise.

How to Install The Ring Light

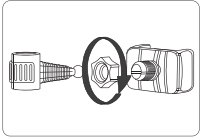

1. Loosen the knob counterclockwise, press the ball part into the hole. Turn the knob clockwise to tighten.

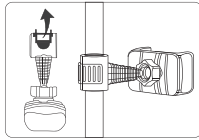

2. Open the buckle, snap the phone holder to the tripod, clutch the metal ring to the appropriate edge, then close the buckle.

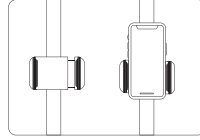

3. Open the phone holder and put the phone into the holder. The angle of the phone can be adjusted at 360°. You can also rotate your phone.

- 4 -

How to Adjust The Brightness

1. Connect the USB plug to power supply (USB socket, computer otebook, portable power).



USB Socket



Portable Power

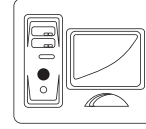

Computer



Notebook

2. Press the power key to turn on or off the light controller.

3. To adjust the brightness, press the + or - button. We offer ten levels of brightness for your preference.

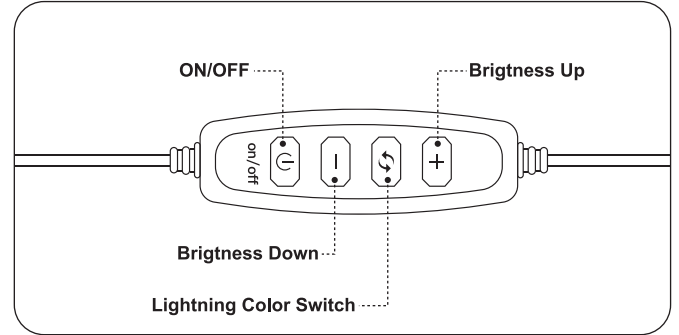

Lighting Controller

- 5 -

4. To adjust the color temperature, press the lighting color switch. We offer three modes: cool light (white), warm light (yellow) and natural light (white + yellow).

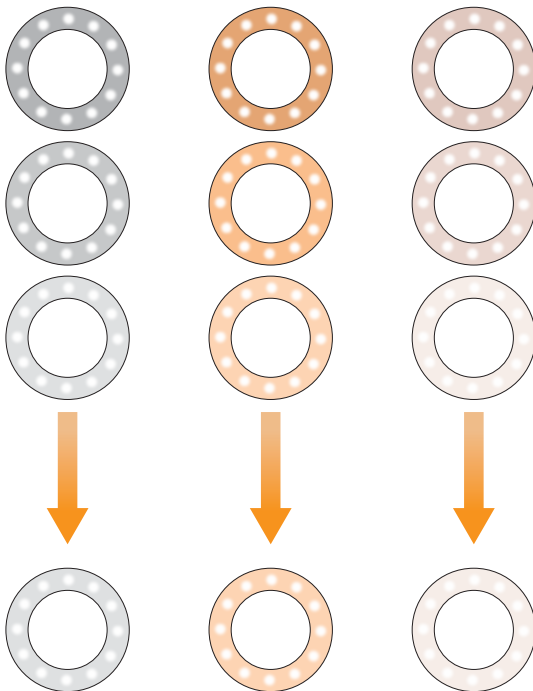

- 6 -

How to Use the Selfie Remote Control

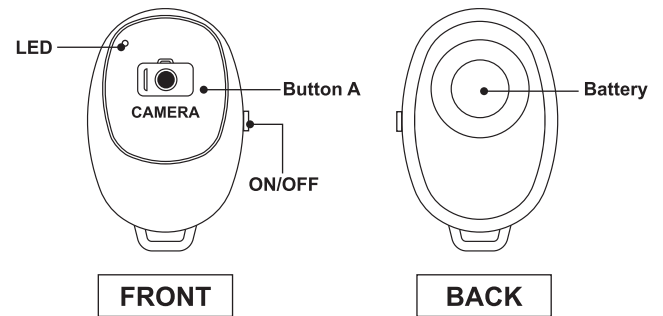

Battery

Please install the battery with the positive electrode facing up

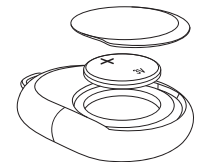

- STEP 1** Turn on the side switch and the blue indicator light flashes.
- STEP 2** Turn on the phone Bluetooth and enter the Bluetooth setting interface.
- STEP 3** Find "AB Shutter3" and click "AB Shutter3". This process may take up to 3 seconds.
- STEP 4** Open the Camera APP on the phone and press the Button A of the remote control to take photos.

- 7 -