

# MELBOURNE WICKER PATIO SOFA

Assembly Instructions

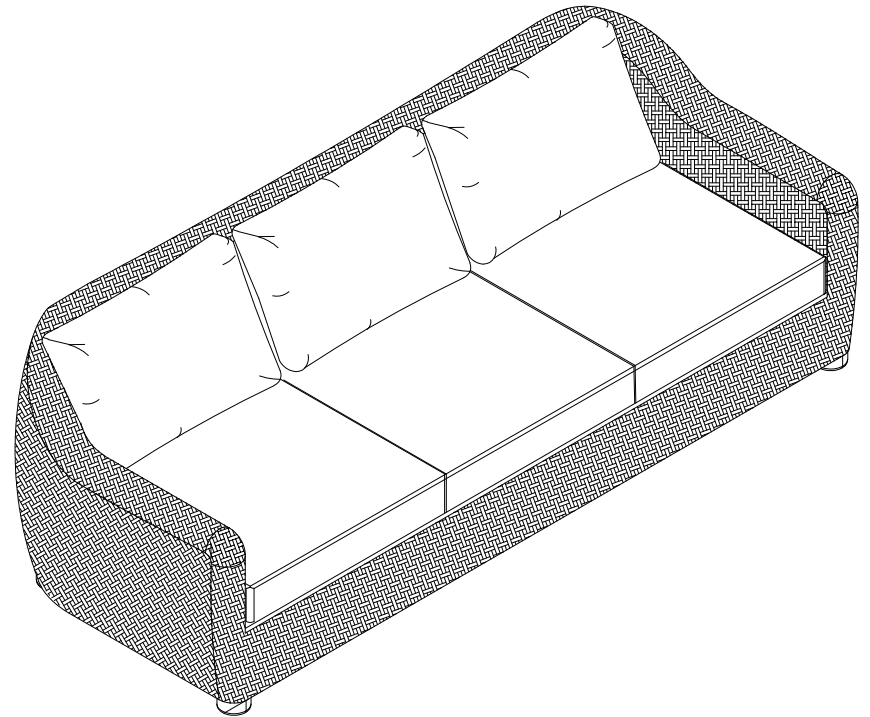

## Need help?

Feel free to contact us via email or call  
if you have any specific questions!

# Thanks for bringing into your home

Everything we make is incredibly simple to set up, including your new Melbourne Wicker Patio Sofa. You won't need any additional tools.

## Parts List

A x 1  
SEAT FRAME

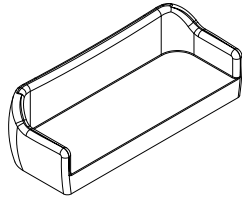

B x 4  
CHAIR LEG



C x 2  
SUPPORT LEG



F x 1  
SEAT CUSHION LEFT

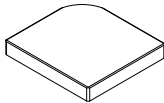

G x 1  
SEAT CUSHION MIDDLE

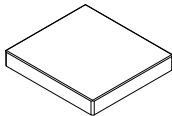

H x 1  
SEAT CUSHION RIGHT

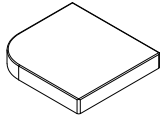

I x 3  
BACK CUSHION



## Hardware List

Hw1 x 8  
Allen bolt M6x20mm



Hw2 x 8  
Allen bolt M6x30mm



Hw3 x 16  
Flat Washer M6



Hw4 x 1  
Allen Key



1

Place the flat washer (HW3) on the Allen bolt (HW2) as shown. Align the screw holes on the legs (B) to the screw holes on the seat frame (A). Attach the legs to the seat frame by using the Allen Key (HW4) to screw in the bolts with the flat washers on them. Place the remaining flat washers (HW3) on the Allen bolts (HW1) as shown. Attach the support legs (C) to the seat frame (A) by using the Allen Key (HW4) to screw in the bolts with the flat washers on them.

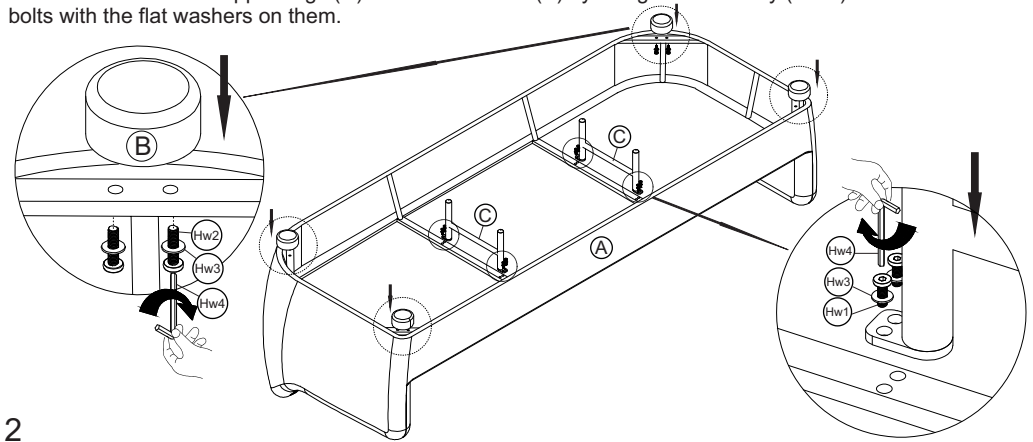

2

Place the seat cushions (F,G,H) and the back cushions (I) on the seat frame (A) as shown.

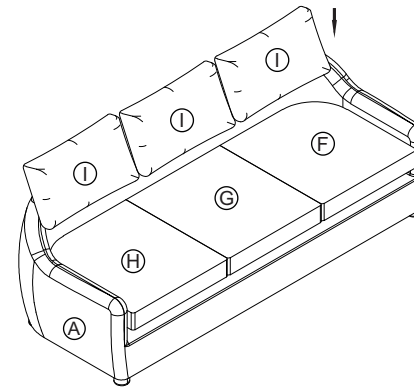

3

Place the sofa in the position you will use it. We'd love to see it – just tag us (we're @safavieh) and use the hashtag #safavieh on Instagram!

