

Assembly Instructions

Caution : You must read this before you proceed

HANGING CHAIR BASE

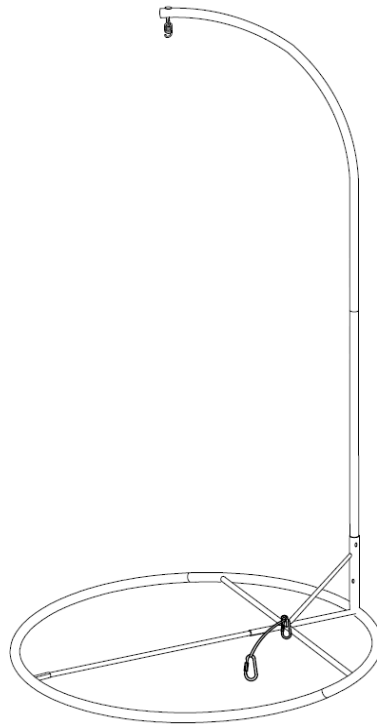





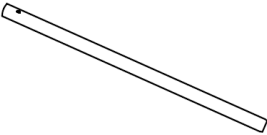
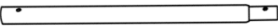
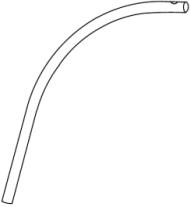



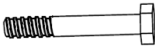

Parts List

Label	Picture	Description	QTY
A	A line drawing of the base part, showing a circular base with a central pivot point and a curved tube attached to the top.	Base	1
B	A line drawing of the left tube part, showing a curved tube with a hook at the end.	Left Tube	1

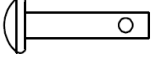
C		Right Tube	1
D		Middle Tube	1
E		Lower Pole	1
F		Upper Pole	1

Hardware

Label	Picture	Description	QTY
①		Hex Bolt (M8x65mm)	3
②		Hex Bolt (M8x55mm)	2
③		Hex Bolt (M8x15mm)	6
④		Washer (M8)	12
⑤		Nut (M8)	4
⑥		Bolt Cap (M8)	9
⑦		Nut Cap (M8)	4
⑧		Hanging Part	1
⑨		Spring	1

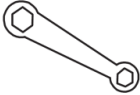
⑩		Safety Line (with Carabiner)	1
⑪		Rubber Ring	1
⑫		Spanner (M8)	1
13		Spanner (M8)	1

Assembly Preparation

Before Beginning Assembly:

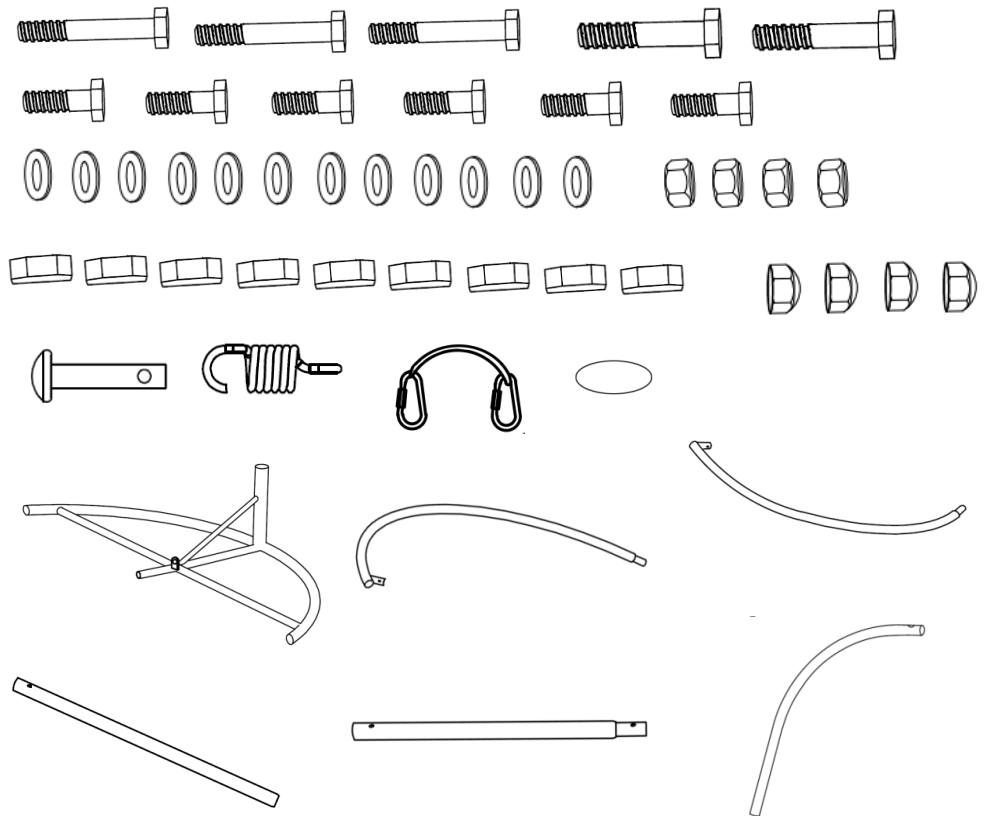

- Read instructions, cover to cover-



- Have 2 adults on hand for assembly-



- Do not assemble on flooring or carpet-



- Assemble on a clean non-marring surface (packing foam)-



- Save all packaging until finished-

Assembly Steps

Overview

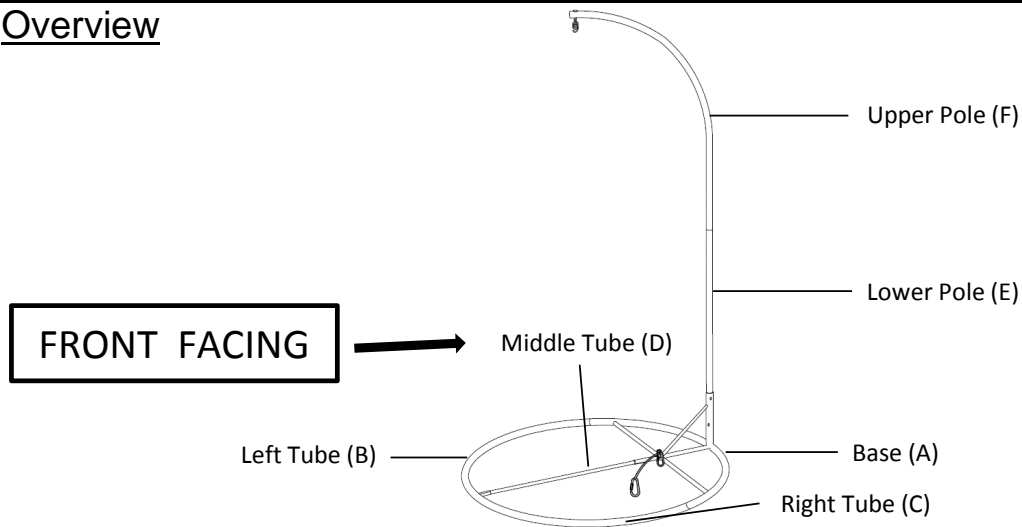

This Hanging Chair Base has multiple parts and may require up to 30 minutes to assemble. To give you an overview of the Hanging Chair Base parts, the above picture is to help you put the various parts into perspective. Please read through the instructions below to familiarise yourself with the parts and steps before assembly.

Step 1

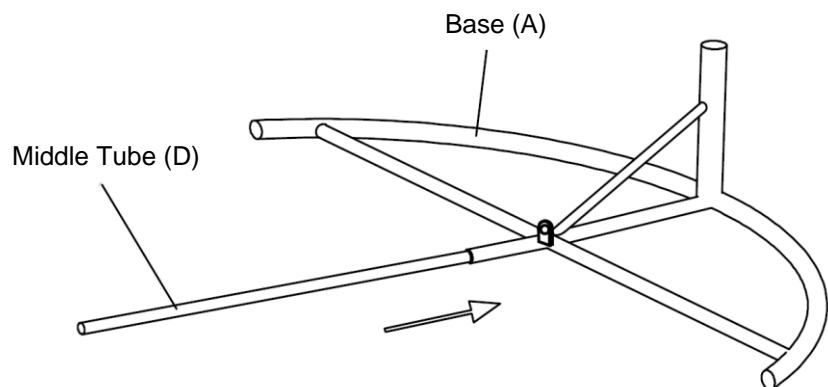

Place the Base(A) and Middle Tube(D) on a clean, non-marring surface. Insert Middle Tube(D) into the Base(A) as pictured.

Step 2

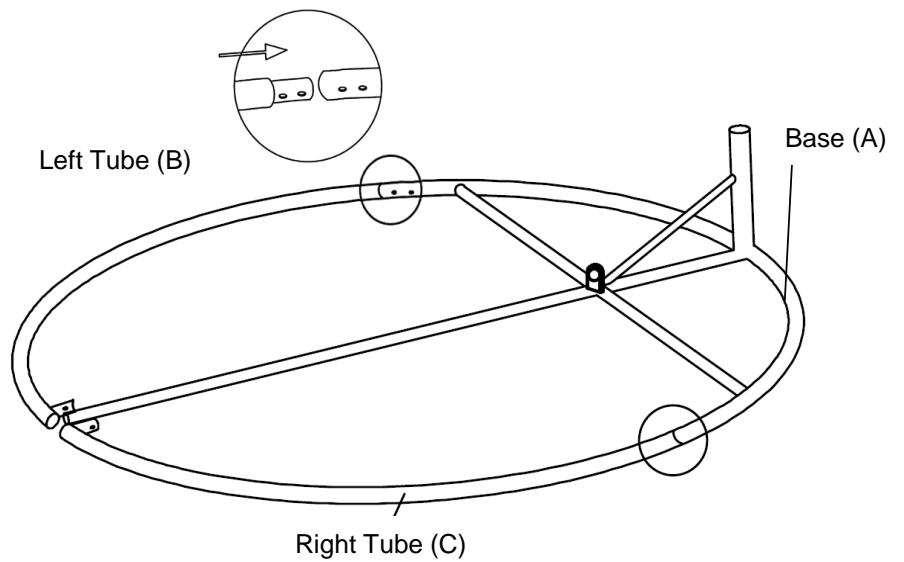

Place the Base(A), Left Tube(B) and Right Tube(C) on a clean, non-marring surface. One by one insert Right Tube(B) and Left Tube(C) into the Base(A).

Step 3

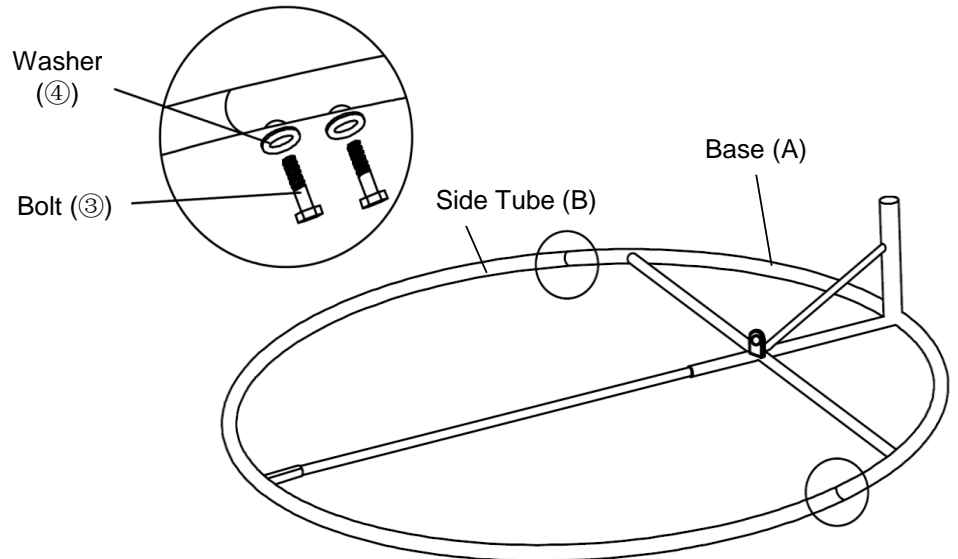

Attach Right Tube (B) and Left Tube (C) to Base (A) using Bolts (③) and Washers (④), with Spanner(12) .

Do not fully tighten the Bolts.

Step 4

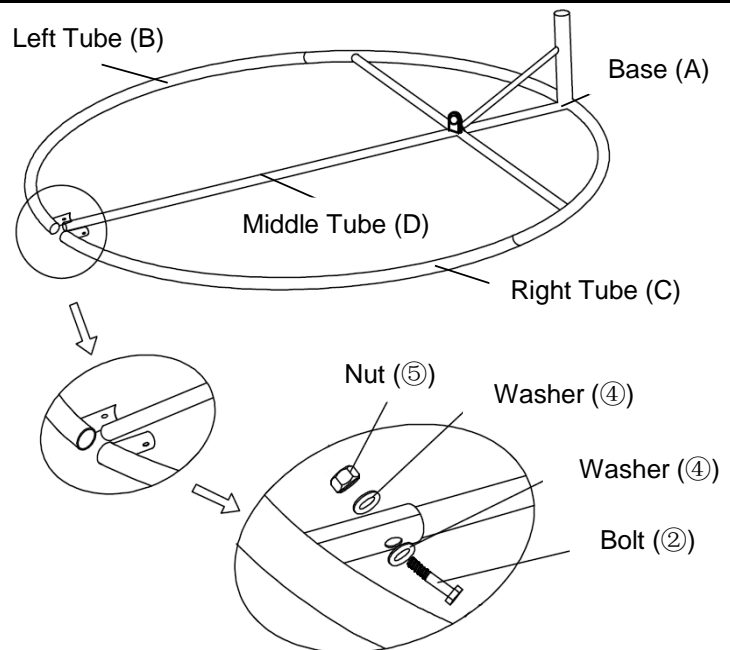

Attach Left Tube(B) and Right Tube(C) to Middle Tube(D) using Bolt(②) and Washer(④) on one side, and using Washer(④) and Nut(⑤) on the other side; tighten with Spanners(12) and Spanner (13).

Do not fully tighten the Bolts.

Step 5

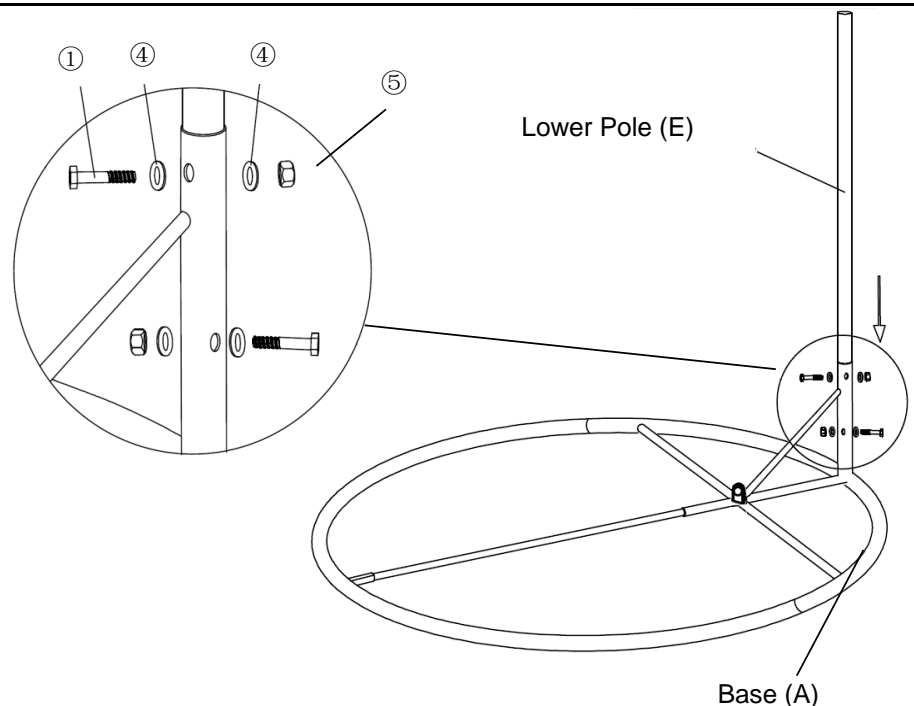

Insert Lower Pole(E) into Base(A), turn the Lower Pole(E) and align mounting positions.

Attention the Lower Pole(E)'s screw holes need to backward.

Attach Lower Pole(E) to Base(A) using Bolts(①) and Washers(④) on one side, and using Washers(④) and Nuts(⑤) on the other side; tighten with Spanners(12) and Spanner (13).

Do not fully tighten the Bolts.

Step 6

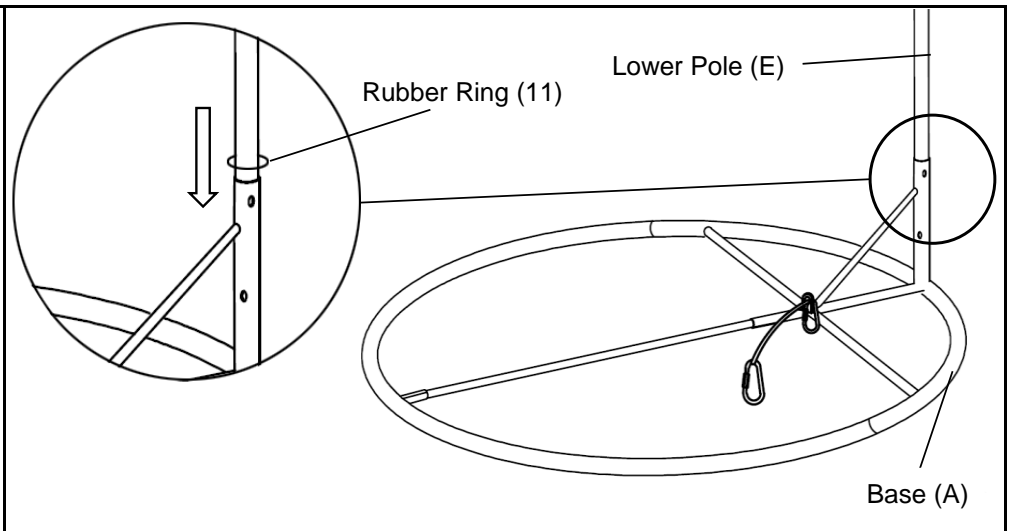

Move the Rubber Ring(11) down the Lower Pole(E) until it is flush with the top of the Base(A).

Step 7

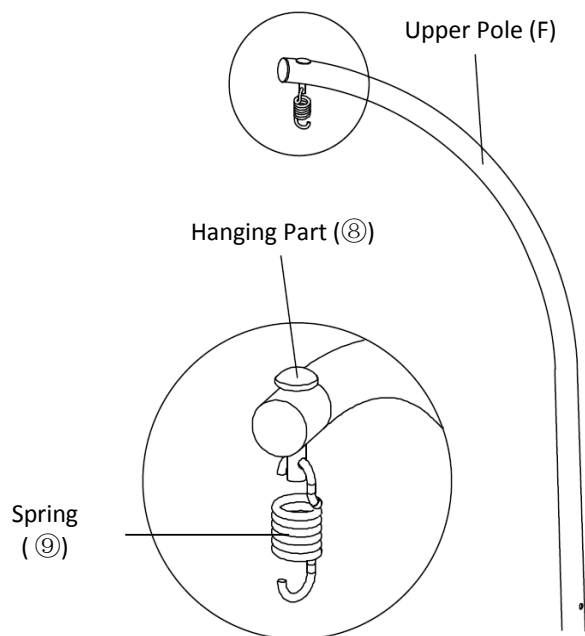

Insert Hanging Part(8) into the top of Upper Pole(F).
Then insert the Spring(9) into the Hanging Part (8).

Step 8

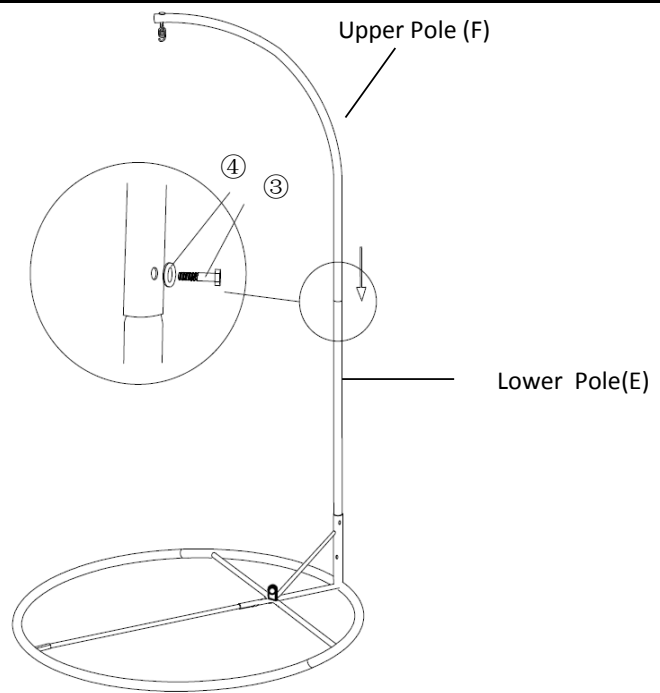

Insert the Upper Pole(F) into Lower Pole(E) and align mounting positions.
Insert Lower Pole(E) into Base(A), turn the Lower Pole(E) and align mounting positions.
Attention the Lower Pole(E) and Upper Pole(F)'s screw holes need to backward.
Attach Upper Pole(F) to Lower Pole(E) using Bolt(③) and Washer(④) with Spanner(12) .
Now, tighten all Bolts and Nuts at all joints sequential manner.
Place Bolt Caps(⑥) on Bolts and Nut Caps(⑦) on Nuts(⑤).

Step 9

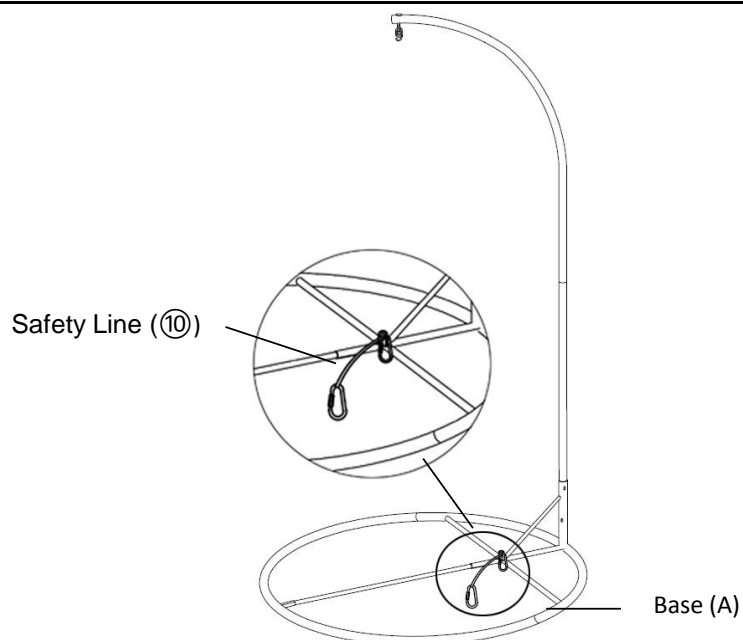

Insert the Carabiner on the Safety Line(⑩) into the Base(A), and screw up the Carabiner.
Your Hanging Chair Base is ready for use.
This Hanging Chair Base can only be used on a flat, level surface.

Step 10

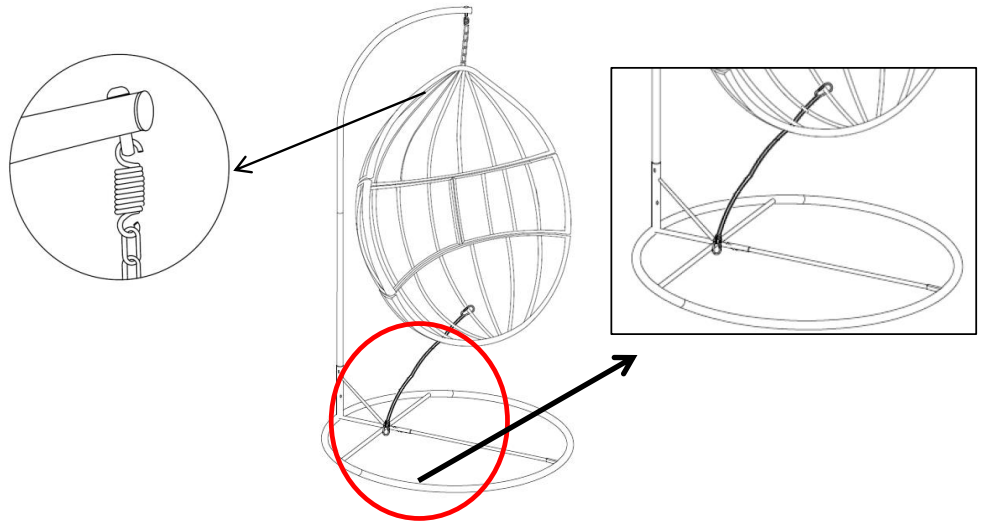



















Lift the Basket and hang the Iron Chain on the Spring of the Hanging Chair Base.
Use the Safety Rope to lock up the middle rattan warp at the bottom of the Basket as shown above.

Screw up the Carabiner to secure the Basket

Note: This Step should be completed with 2 adults.

Care & Maintenance

-   • Do not put hot items directly on furniture surface
 -   • Do not clean furniture with harsh cleansers or polish.
 -   • To obtain the longest lifespan of your outdoor products, minimizing exposure to direct sunlight is recommended.
 -   • Children should not climb or jump on the furniture.
 -   • Do not write on furniture without a padded barrier to protect the surface.
 -   • To obtain the longest lifespan of your outdoor products, avoid extended and lengthy exposure to rain, snow, and direct sunshine. Whenever possible cover the product and /or place under patio or awnings.
 -   • Not for commercial use. For residential use only .
 -   • Stains may be removed with mild soap solution and damp cloth.
-
-   • Dust and pick-up spills using a clean, non-colored, lint-free cloth .

Questions & Answers about Proposition 65

• What is Proposition 65?

Proposition 65 requires businesses to provide warnings to Californians about significant exposures to chemicals that cause cancer, birth defects or other reproductive harm. These chemicals can be in the products that Californians purchase, in their homes or workplaces, or that are released into the environment. By requiring that this information be provided, Proposition 65 enables Californians to make informed decisions about their exposures to these chemicals.

Proposition 65 also prohibits California businesses from knowingly discharging significant amounts of listed chemicals into sources of drinking water.

Proposition 65 requires California to publish a list of chemicals known to cause cancer, birth defects or other reproductive harm. This list, which must be updated at least once a year, has grown to include approximately 900 chemicals since it was first published in 1987.

• What types of chemicals are on the Proposition 65 list?

The list contains a wide range of naturally occurring and synthetic chemicals that include additives or ingredients in pesticides, common household products, food, drugs, dyes, or solvents. Listed chemicals may also be used in manufacturing and construction, or they may be byproducts of chemical processes, such as motor vehicle exhaust.

• What does a warning mean?

If a warning is placed on a product label or posted or distributed at a workplace, a business, or in rental housing, the business issuing the warning is aware or believes that it is exposing individuals to one or more listed chemicals.

By law, a warning must be given for listed chemicals unless the exposure is low enough to pose no significant risk of cancer or is significantly below levels observed to cause birth defects or other reproductive harm.

• Where can I get more information on Proposition 65?

If you have specific questions on the administration or implementation of Proposition 65, you can contact OEHHA's Proposition 65 program at P65.Questions@oehha.ca.gov, or by phone at (916) 445-6900.