



Vinnova Inc.

## INSTALLATION SPECIFICATION

Item No.	301056-BP-BN
Description	By-pass
Overall Dimensions	56"x76"
Installation Size Range	52"-56"
Profile Color	Brushed Nickel
Glass Thickness	8/25"
Glass Color	Transparent&Easy clean
Gross Weight	138 LBS
Certifications	ANSI Z97.1-2015

*All measurements are approximate. Measurements may vary +/- 1/25".*

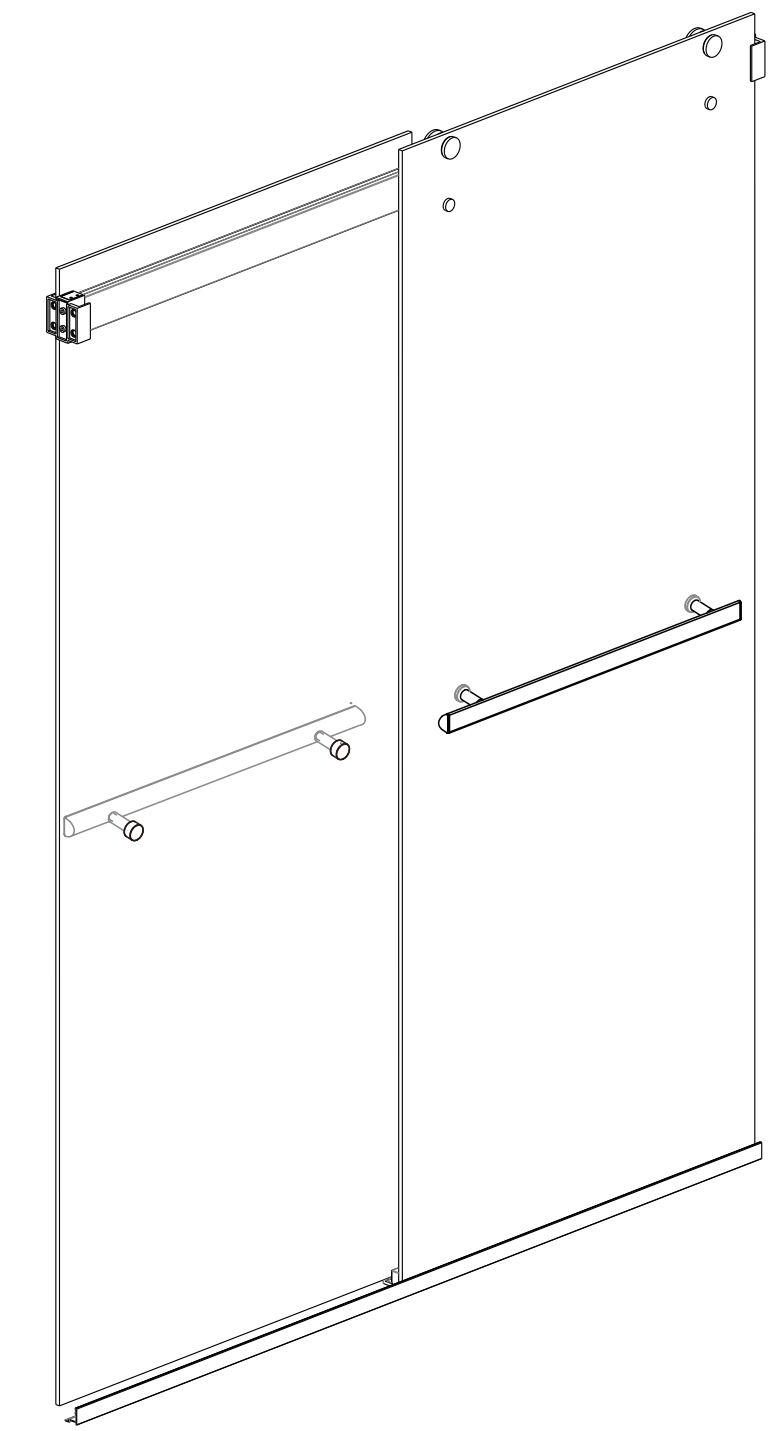

**Spezia  
By-pass**

