

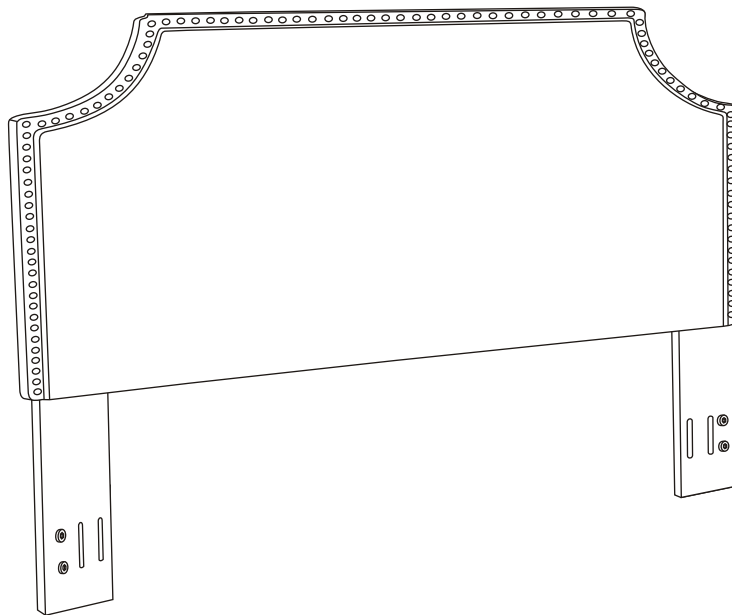

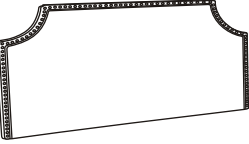





Uphostered Headboard



PARTLIST

<div data-bbox="150 174 188 219" style="border: 1px solid black; padding: 2px;">A</div> 	<div data-bbox="411 174 450 219" style="border: 1px solid black; padding: 2px;">B</div> 	<div data-bbox="676 174 715 219" style="border: 1px solid black; padding: 2px;">C</div> 
<p>Headboard Panel 1 PC</p>	<p>Left Headboard Post 1 PC</p>	<p>Right Headboard Post 1 PC</p>

HARDWARE LIST

<div data-bbox="150 1207 188 1252" style="border: 1px solid black; padding: 2px;">#1</div>  <p>5/16"x1-3/4"L</p>	<div data-bbox="411 1207 450 1252" style="border: 1px solid black; padding: 2px;">#2</div> 	<div data-bbox="676 1207 715 1252" style="border: 1px solid black; padding: 2px;">#3</div> 	<div data-bbox="941 1207 979 1252" style="border: 1px solid black; padding: 2px;">#4</div> 	<div data-bbox="1206 1207 1244 1252" style="border: 1px solid black; padding: 2px;">#5</div>  <p>M5</p>
<p>Bolt 15PCS(Extra1)</p>	<p>Spring Washer 19PCS(Extra1)</p>	<p>Flat Washer 19PCS(Extra1)</p>	<p>Nut 5PCS(Extra1)</p>	<p>Allen Key 1 PC</p>
<div data-bbox="150 1612 188 1657" style="border: 1px solid black; padding: 2px;">#6</div>  <p>Allen Wrench 1 PC</p>				

Step 1. Lay headboard panel (part A) down on a soft surface, such as carpet, as shown below. Attach left headboard post (part B) and right headboard post (part C) to headboard panel (part A) using bolts (part #1), spring washers (part #2), flat washers (part #3) and allen key (part #4).
 NOTE: Please do not fully tighten bolts until unit is fully assembled.

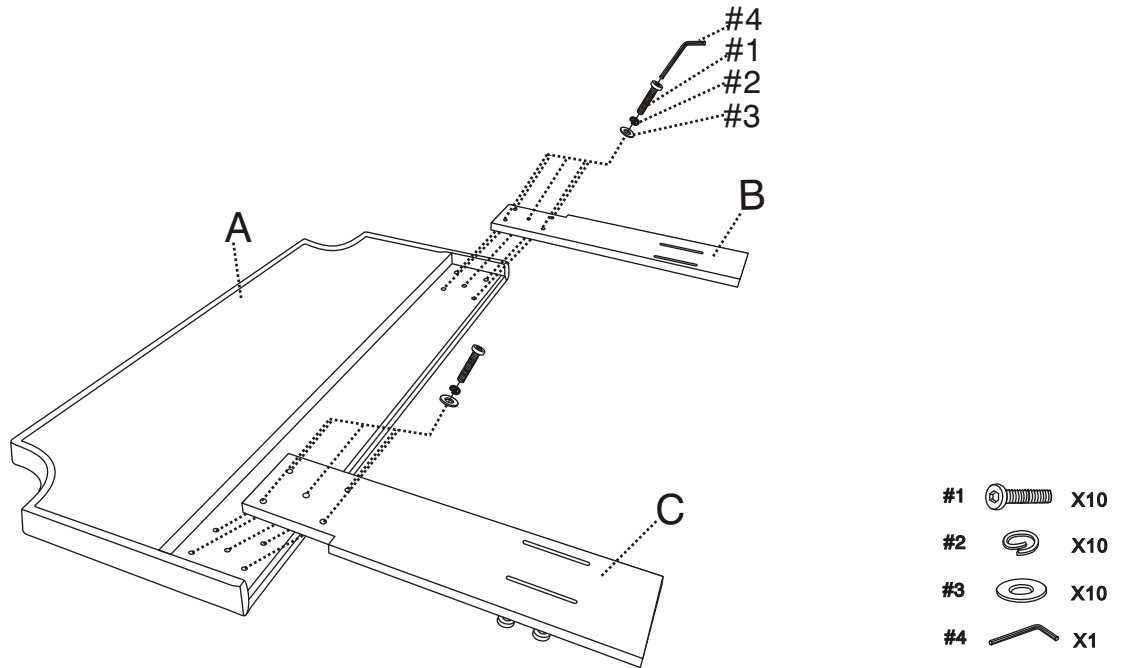

Step 2. Screw out the bolts on the headboard posts using allen key (part #5). Attach bed frame (*Not Included) to left headboard post (part B) and right headboard post (part C) using bolts (part #1), spring washers (part #2), flat washers (part #3), nuts (part #4), allen key (part #5) and allen wrench (part #6).

