





Assembly Instruction

8294-2013

Thank you for purchasing this quality product! Make sure all components and small hardware parts are included in the package before you start to assemble the product.

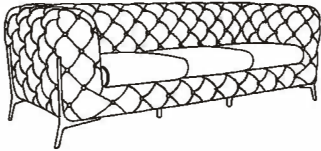
Components List

Hardware List

Serial No.	Description and Drawing	Quantity	Serial No.	Description and Drawing	Quantity
A		X1	1		4
			2		2
			3		28
			4	Spare Hanging Screws 	2

Step 1

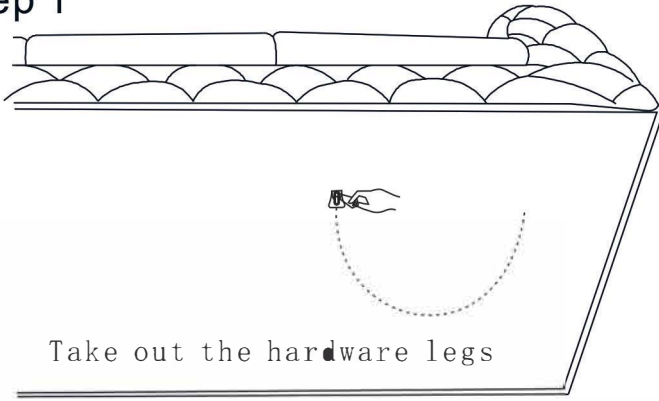

Step 2

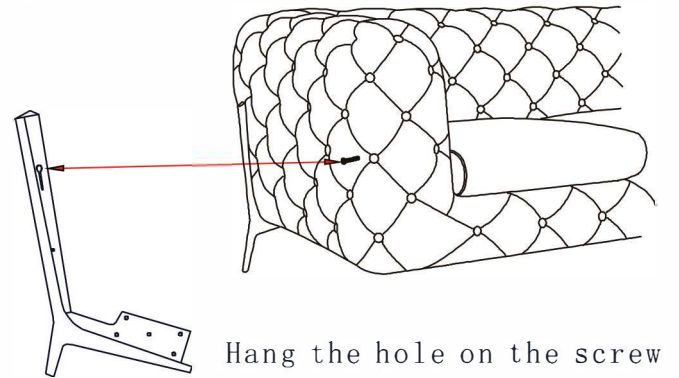

Step 3

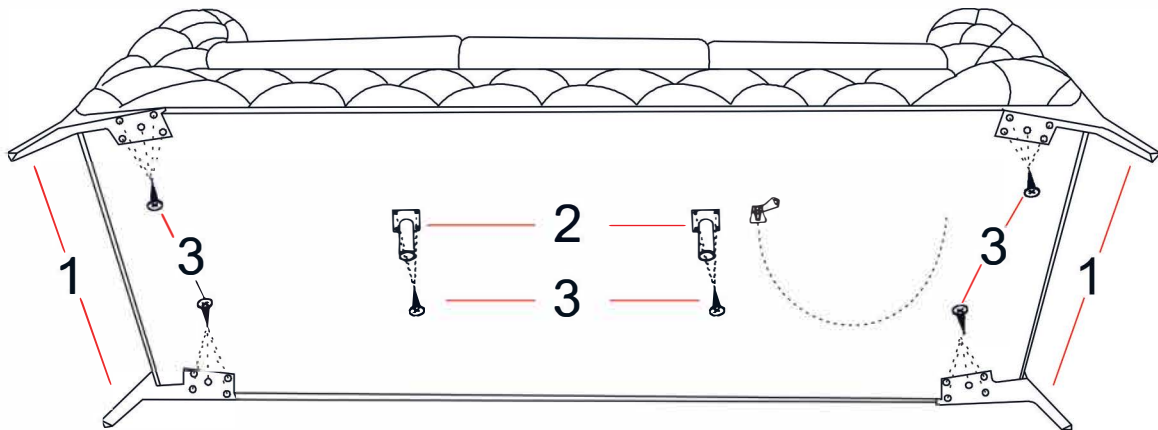

Step 4 Finished

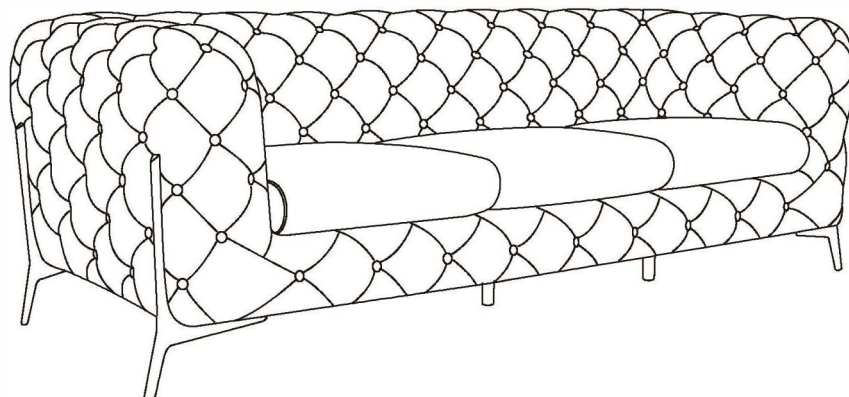





Assembly Instruction

Thank you for purchasing this quality product! Make sure all components and small hardware parts are included in the package before you start to assemble the product.

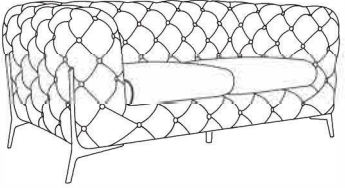
Components List

Hardware List

Serial No.	Description and Drawing	Quantity	Serial No.	Description and Drawing	Quantity
A		X1	1		4
			2		1
			3		24
			4	Spare Hanging Screws 	2

Step 1

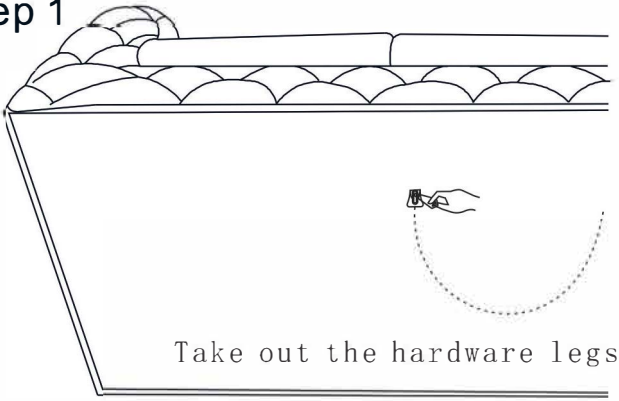

Step 2

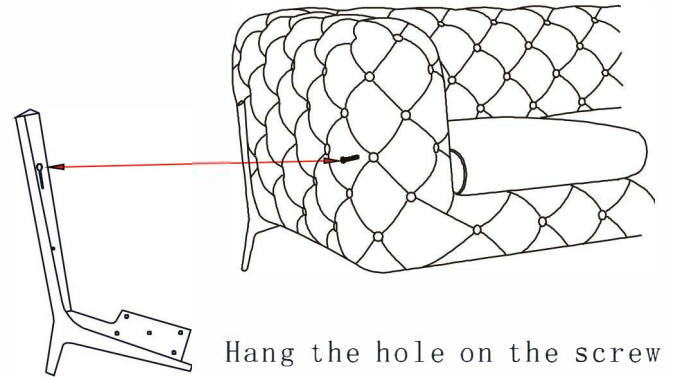

Step 3

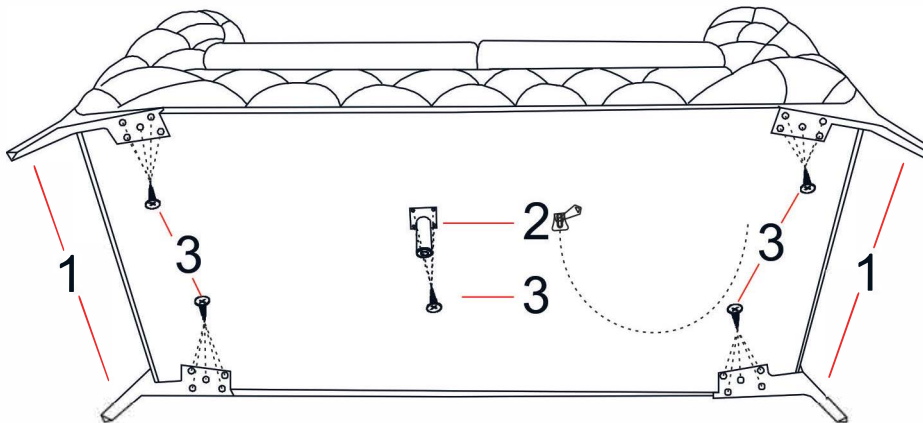

Step 4 Finished

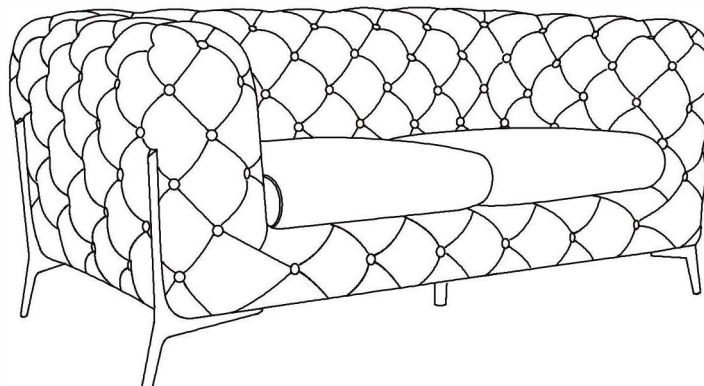





Assembly Instruction

2024.05.17

Thank you for purchasing this quality product! Make sure all components and small hardware parts are included in the package before you start to assemble the product.

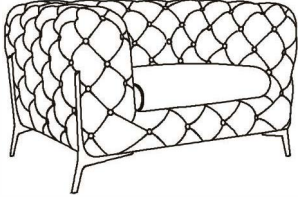
Components List

Hardware List

Serial No.	Description and Drawing	Quantity	Serial No.	Description and Drawing	Quantity
A		X1	1		4
			2		20
			3	Spare Hanging Screws 	2

Step 1

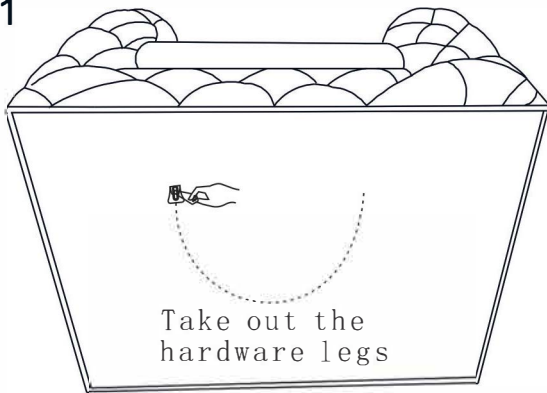

Step 2

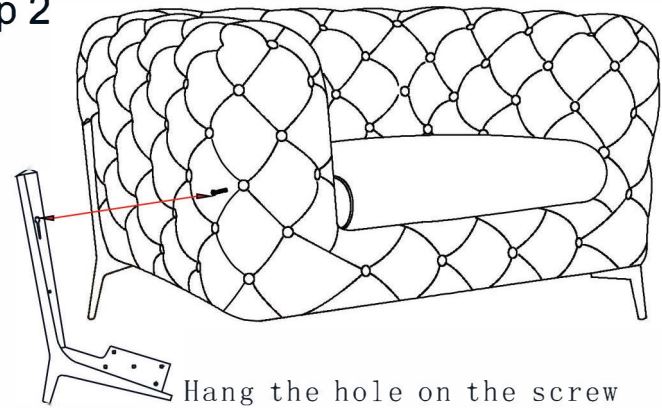

Step 3

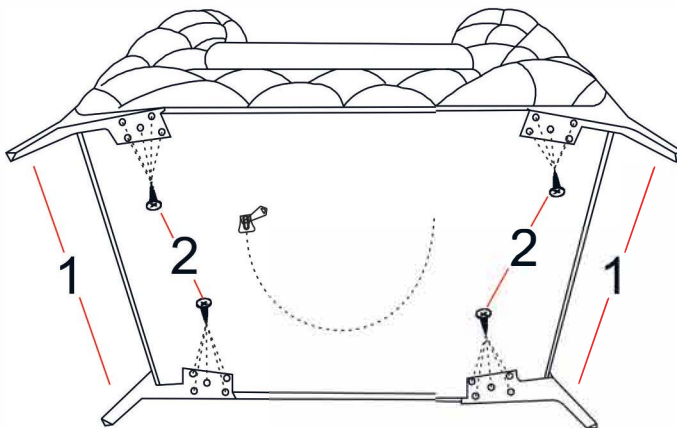

Step 4 Finished

