

# ASSEMBLY INSTRUCTION

Dear Customer,

Thanks for choosing our product.





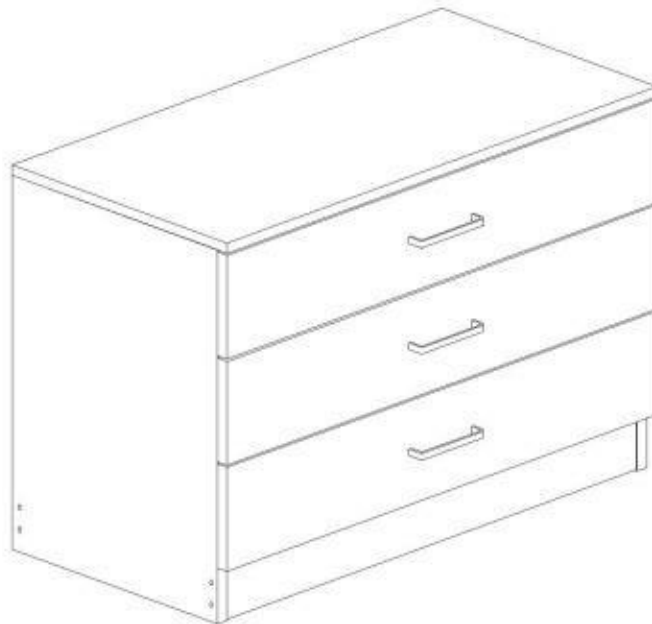



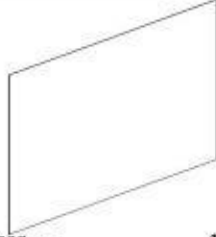

Please kindly note that this manual should always come with the desk while assembling.

And please read the manual carefully and keep the desk away from damages caused by improper assembly.









# Components of furniture

Please check the board number and the hole on the board

<p><b>1</b></p>  <p>660×330mm      1 PC</p>	<p><b>2</b></p>  <p>540×315mm      1 PC</p>	<p><b>3</b></p>  <p>540×315mm      1 PC</p>	<p><b>4</b></p>  <p>460×638mm      1 PC</p>
<p><b>5</b></p>  <p>630×95mm      1 PC</p>	<p><b>6</b></p>  <p>630×80mm      1 PC</p>	<p><b>7</b></p>  <p>660×150mm      3 PCS</p>	<p><b>8</b></p>  <p>290×80mm      3 PCS</p>
<p><b>9</b></p>  <p>290×800mm      3 PCS</p>	<p><b>10</b></p>  <p>580×80mm      3 PCS</p>	<p><b>11</b></p>  <p>588×285mm      3 PCS</p>	

## Hardware accessories

<p><b>A</b></p>  <p>16 PCS</p>	<p><b>B</b></p>  <p>M5×50mm      20 PCS</p>	<p><b>C</b></p>  <p>M3.5×12mm      24 PCS</p>	<p><b>D</b></p>  <p>3 PCS</p>
<p><b>E</b></p>  <p>M4×18mm      6 PCS</p>	<p><b>F</b></p>  <p>6 PCS</p>		

## "A" Hardware installation example

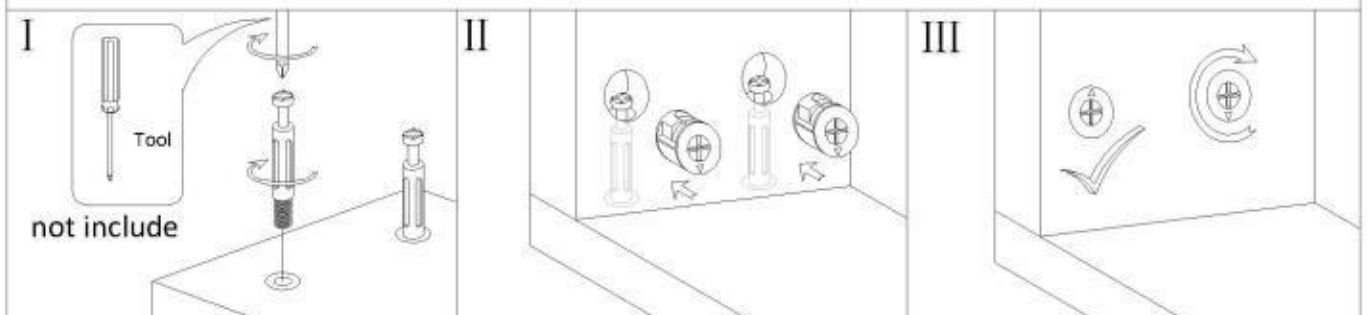

## "F" Hardware disassembly example



# Start assembling furniture

## STEP 1

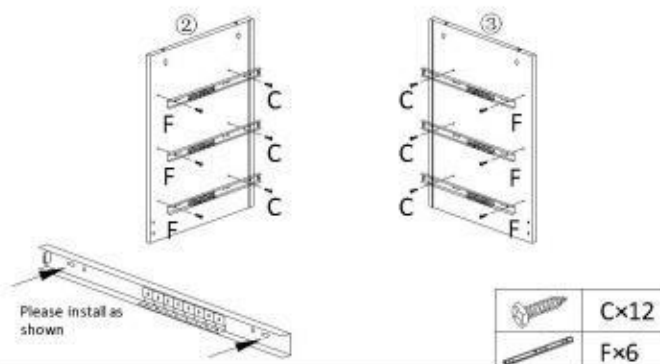

## STEP 2

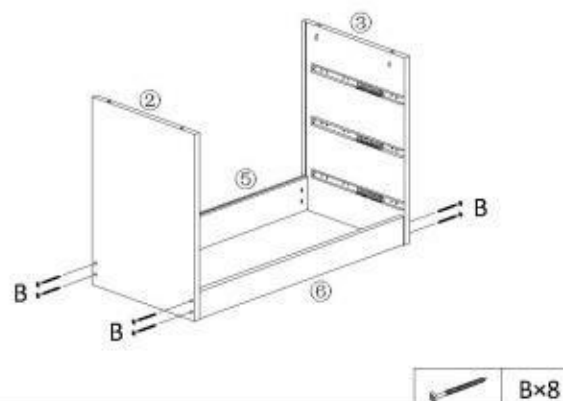

## STEP 3

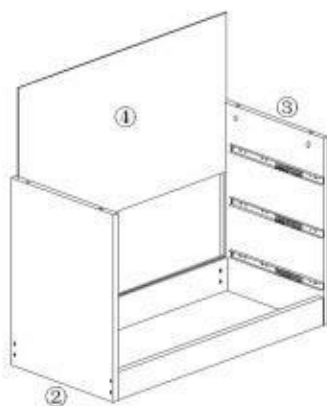

## STEP 4

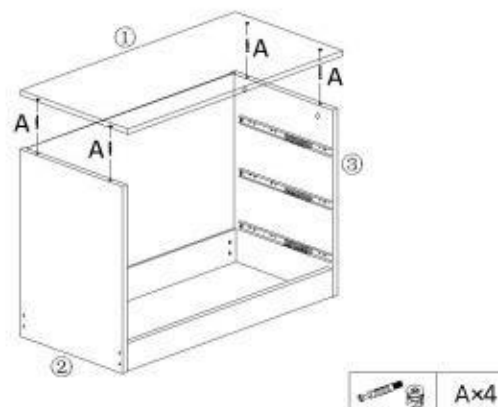

## STEP 5 x3

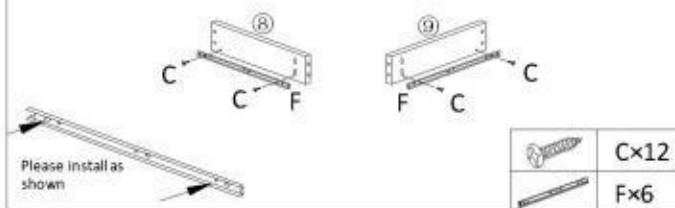

## STEP 6 x3

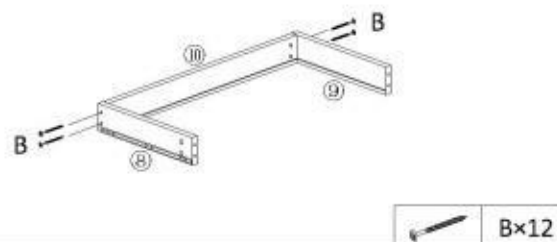

## STEP 7 x3

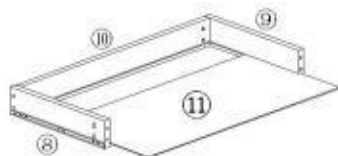

## STEP 8 x3

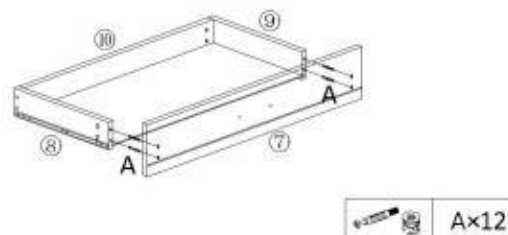

## STEP 9 x3

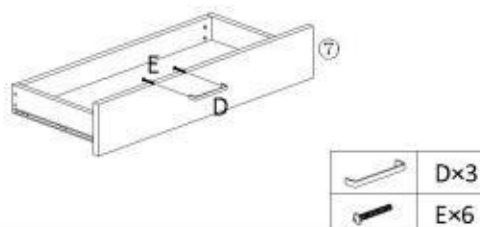

## STEP 10

