



ASSEMBLY INSTRUCTIONS

DRESSER & MIRROR



BOX OF DRESSER

ITEM	DRAWING	DESCRIPTION	QTY
A		DRESSER	1

BOX OF MIRROR

ITEM	DRAWING	DESCRIPTION	QTY
B		MIRROR	1
C		MIRROR SUPPORT	2

(BOX OF MIRROR) HARDWARE LIST

ITEM	DRAWING	DESCRIPTION	QTY
1		FLAT HEAD SCREW (M4 x 32mm)	8
2		Assembly Tool Not Included	1

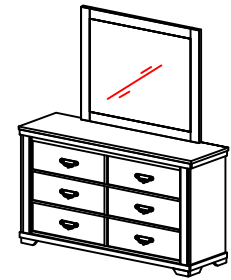

COMPLETED DRESSER & MIRROR ASSEMBLY

STEP 1

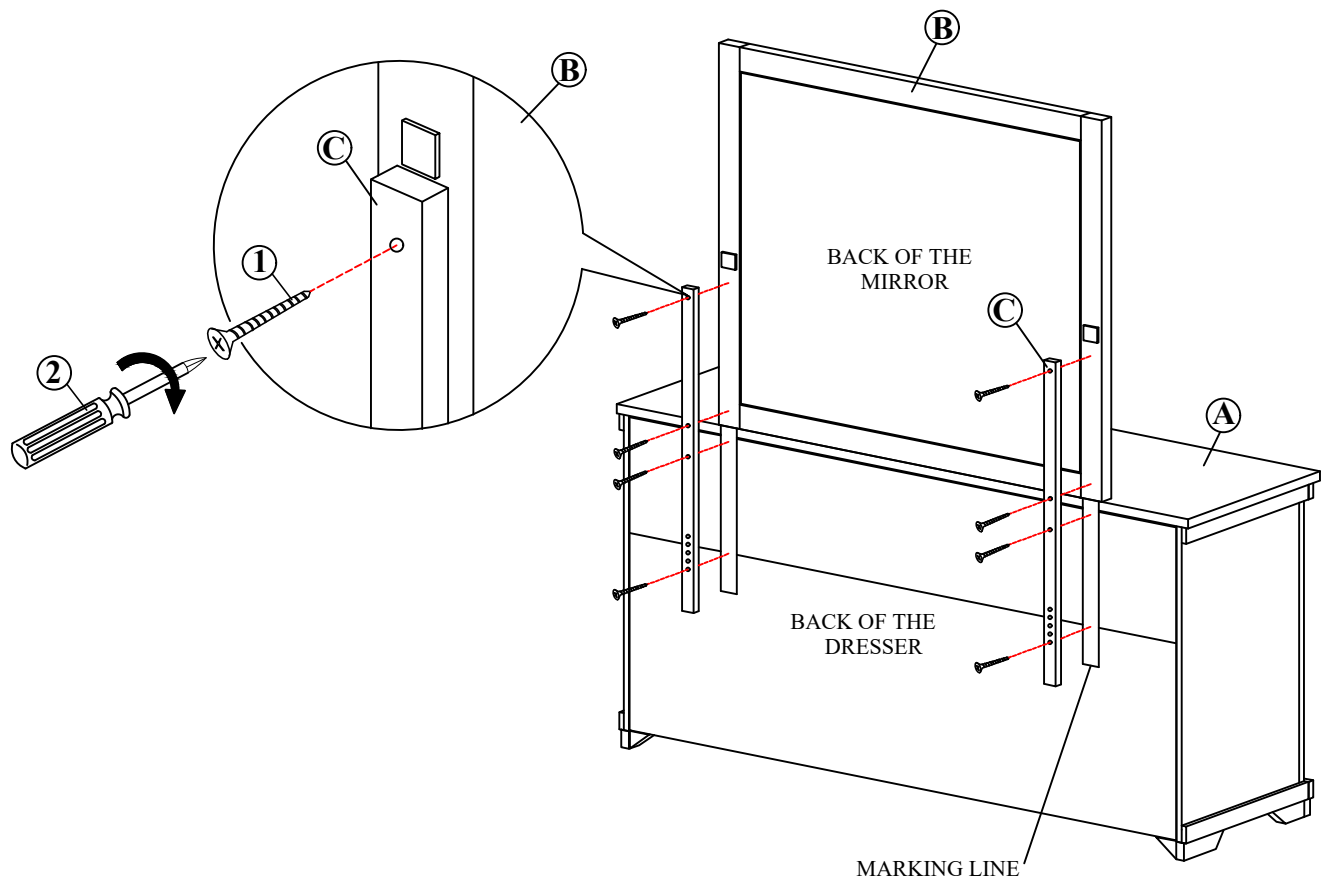

THE HARDWARE IS LOCATED IN THE PACKING ITEMS

THE ANTI TIPPING HARDWARE IS LOCATED IN THE 1ST RIGHT SIDE FRONT DRAWER OF THE DRESSER.

NOTE : MUST TIGHTEN SCREWS PERIODICALLY. WITH USE SCREW MAY BECOME LOOSE.
CHECK TIGHTNESS OF ALL SCREW EVERY 6-8 WEEKS.

CLEANING INSTRUCTION

After assembly, clean & polish the completed parts if necessary with soft cloth and industrial recognized furniture polish