

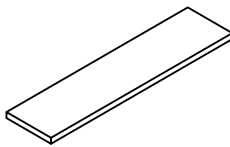





ASSEMBLY INSTRUCTIONS

HARDWARE			COMPONENT		
No	Description	Q'ty	No	Description	Q'ty
1	Bolt Ø6*100 	1Pc	A		1Pc
2	Bolt Ø8*20 	8Pcs	B		1Pc
3	Bolt Ø8*50 	2Pcs	C		2Pcs
4	Washer 	11Pcs			
5	Allen Key 	1Pc			

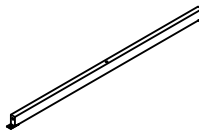

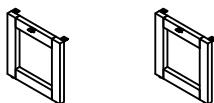
MADE IN VIETNAM

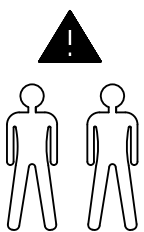
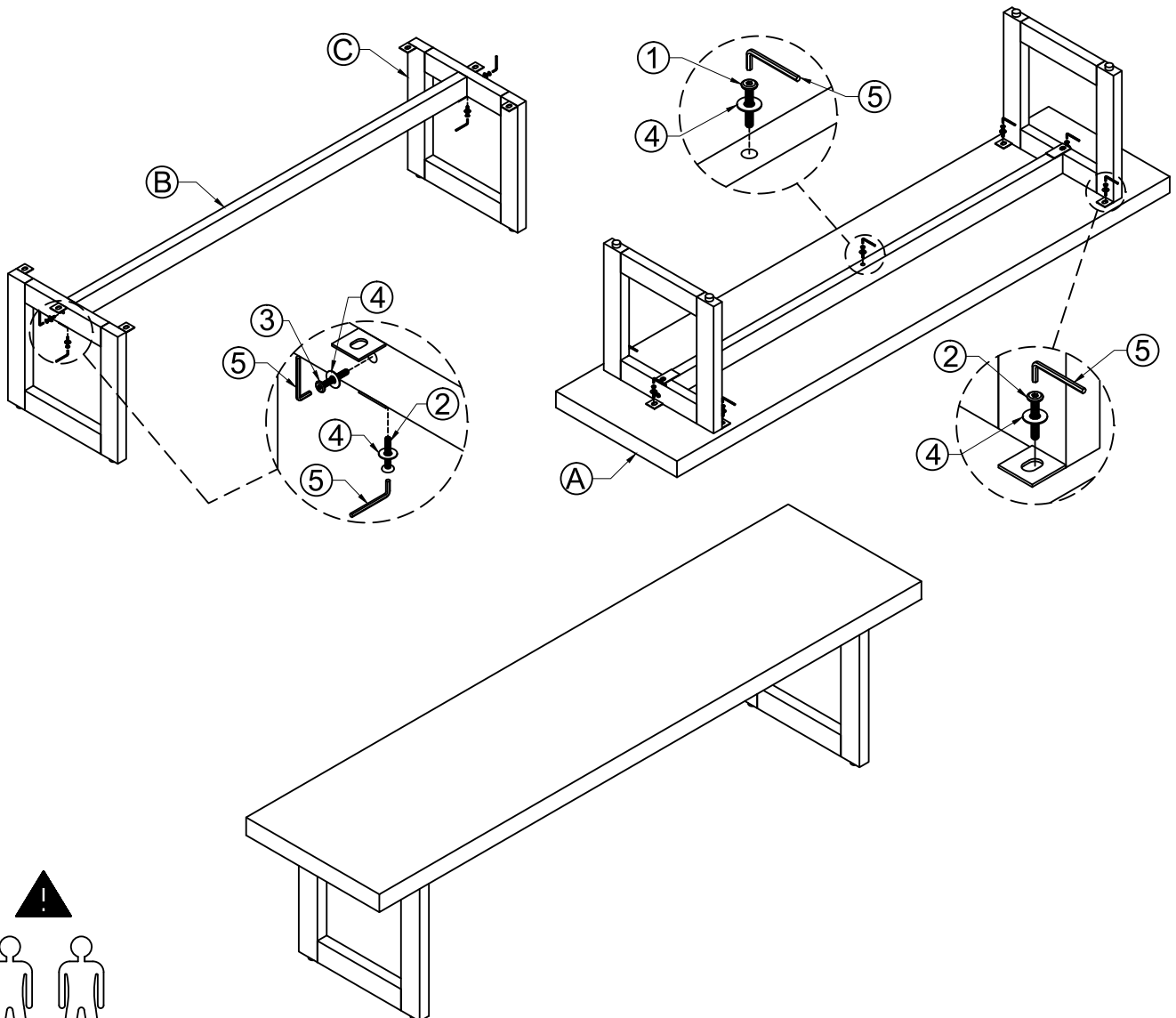
01/01