

RVG1080

GRANITE TOPMOUNT KITCHEN SINK

RUVATI[®]
SPECIFICATION SHEET

MATERIAL

- Solid Granite Composite
- 80% crushed natural granite for extreme strength
- Non-porous and resistant to stains

FEATURES

- Single-Tier Ledge for Accessories
- Will never discolor
- Naturally sound proof

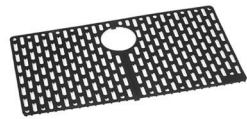

COLOR OPTIONS

BK: Midnight Black

WH: Arctic White

ES: Espresso Brown

UG: Urban Gray

WB: Soft White

IN THE BOX



Basket Strainer
[RVA1038BL/WH/GR]

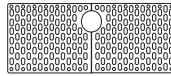

Rinse Grid
[RVA41080BK/GR]

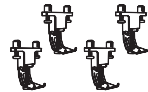

Mounting Clips
[RVA11055]



Cut-out
Template

NOMINAL DIMENSIONS

Exterior: 33" (wide) x 22" (front-to-back)

Interior Bowl: 30-1/4" (wide) x 16-3/4" (front-to-back)

Bowl Depth: 9-1/2"

Minimum Cabinet Size: 36" wide

Drain Hole Size: 3 1/2"

Installation Type:
Topmount

Inside Corners:
Rounded

Drain Location:
Rear Center

RUVATI USA

www.ruvati.com

Phone: 1.855.478.8284
Email: support@ruvati.com

OPTIONAL ACCESSORIES (SOLD SEPARATELY)

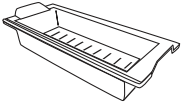

Colander
[RVA1367BLK]



Condiment
Serving Tray
[RVA1377BWC]

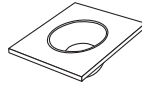

Mixing Bowl
and Platform
[RVA1288BWC]

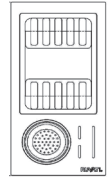

Drying Rack
[RVA1542BWC]

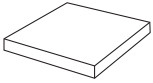

Butcher Block
[RVA2445ACA]

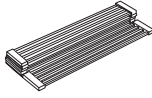

Folding Rack
[RVA1395]

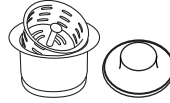

Deep Basket
Disposal Flange/Stopper
[RVA1052BL/GG]

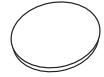

Drain Cover
[RVA1034BK/WH]

DIMENSIONS

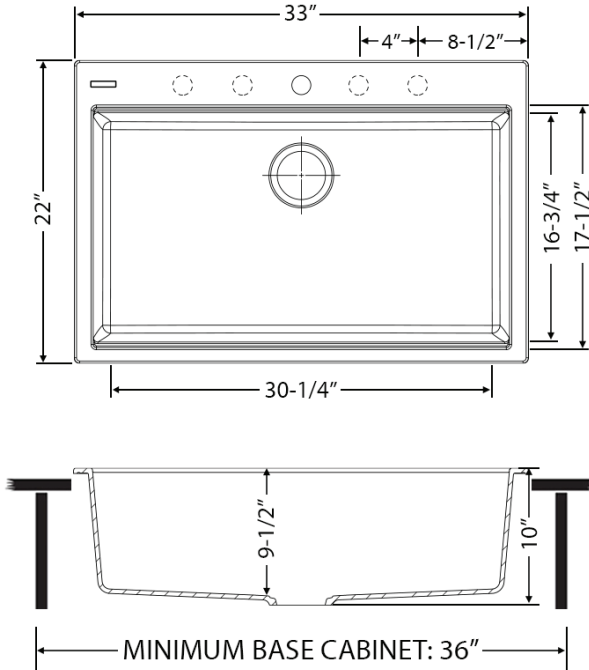

cUPC certified by IAPMO
to meet US and Canada
plumbing standards.



**SCAN TO REGISTER
YOUR WARRANTY**

or visit
ruvati.com/register

RUVATI USA
www.ruvati.com

Phone: 1.855.478.8284
Email: support@ruvati.com