

# Ottoman Assembly Instructions

Your ottoman comes packaged in one box.





**DO NOT use any sharp objects to open plastic wrapped components as damage to product or components may result.**

Carefully remove all of the components from the packaging and set aside for assembly. Assemble on a soft surface to prevent scratching the finish.

Estimated Assembly  
Time in Minutes

★ ☆ ☆  
<15 <45 60+

## Parts List

<b>A</b> 1 x Seat		<b>*D</b> 4 x Washers 	Ø47mm
<b>B</b> 2 x Arms		<b>*Replaceable Parts</b>	
<b>*C</b> 4 x Legs			

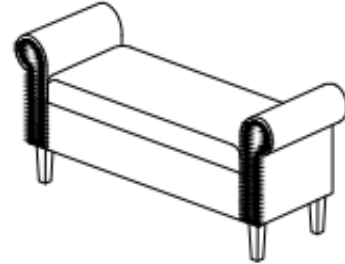

## Assembly

### Step 1

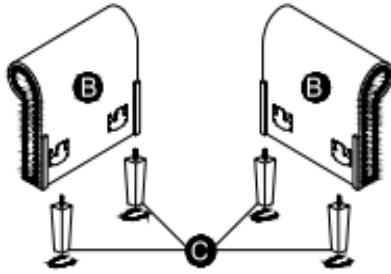

### Step 2

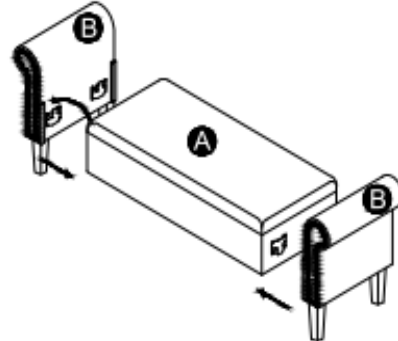

### Step 3

#### OPTIONAL

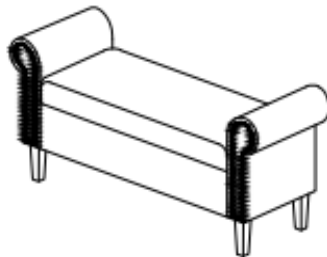
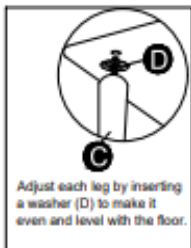

### Step 4

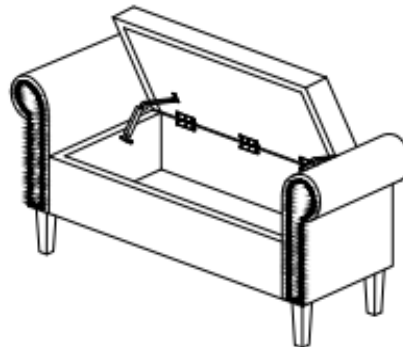

Your style may differ from images. Care for your furniture by periodically tightening all legs.

**CAUTION:** Tighten all components securely before use. Failure to do so may result in personal injury.

About your furniture piece:

- Softening of foam is natural and will happen over time with use.
- Fabric will fade or discolor in direct sunlight. Minimize exposure to direct sunlight to extend the life of your furniture.
- Wood grain, knots, streaks, and color variation occur naturally in wood and are not considered defects.

Customer Support: 866-238-0531  
Mon-Fri 8:00am - 4:30pm CST  
customerservice@furniturequestions.com