

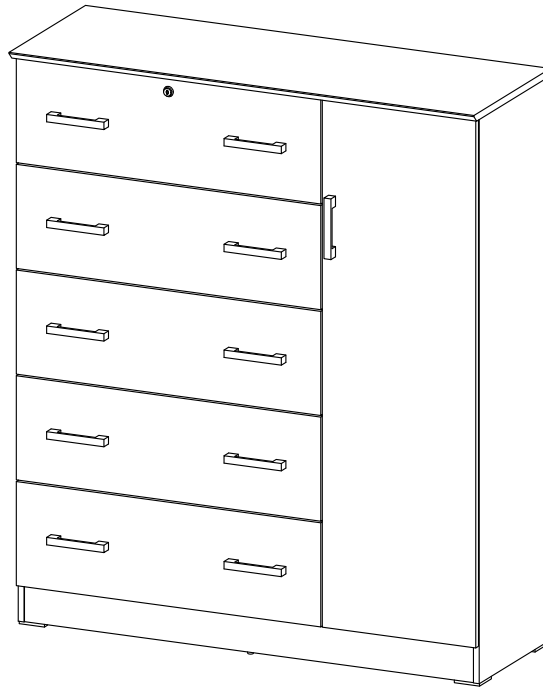















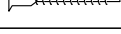







# WP FURNITURE / INSTRUCTIONS



## Hardware List

A2		Screw m3.5 x 14mm	96 pcs	F2		Mini Fix 15mm	26 Sets
A4		Screw m3.5 x 20mm	4 pcs	H21		Handle 128mm	11 pcs
A7		Screw m4 x 30mm	22 pcs	L1		Leg Pin	2 pcs
A10		Screw m4 x 38mm	20 pcs	L2		Plastic Leg L Shape	4 pcs
A17		Screw m6.3 x 40mm	12 pcs	M18		2 Way Slide_342mm	5 sets
A34		Euro Screw m5 x 8mm	20 pcs	N1		Allen Key	1 pc
A40		TH Screw m4 x 10mm	10 pcs	P		Hanging Steel Pipe 18mm x 396mm	1 pc
C5		Square Lock Set	1 Set	Q4		Plastic Shelf Support with Steel Pin	8 pcs
C8		Square Lock L Bracket	1 pc	R1		L-Bracket	2 pcs
D4		Wood Dowel 6 x 25mm	20 pcs	R2		Single Plastic Cap	58 pcs
D6		Wood Dowel 8 x 25mm	8 pcs	S2		Door Stopper	1 pc
E5		Soft Close Hinges 5/8"	2 pcs	Y		Crosshead Cover	10 pcs
E21		Anti Tipping Pack	2 Sets				

**\* Extra screw for your commitment.**

**\* Please assemble flat or nice service.**

MADE IN MALAYSIA

Page 1/23

# **"Congratulations on Your Recent Purchase! Here Are Some Tips Before You Begin Assembling:"**

"Preparing for your exciting new purchase? Be sure to set yourself up for a smooth assembly process by following these steps:"

- First, we recommend using a rug or any large clean surface as your workspace to provide a sturdy base for assembly.
- Next, it is important to separate all components and identify each part by their designated letters. This will make it easier to follow the assembly instructions and ensure all pieces are placed correctly.
- Additionally, on a clean surface separate and identify all screws lengths and hardware. You can use the assembly instructions as a guide and place the screws on top of the actual size pictured. This will save you time and confusion during the assembly process.
- Finally, we highly encourage you to carefully read through the assembly instructions and start from step one. Follow each step diligently until your new purchase is fully assembled. However, if you have any questions or need further assistance, please do not hesitate to reach out to us via email.

**Thank you again for choosing our product.  
We wish you all the best and happy assembling!**

# WP FURNITURE / INSTRUCTIONS

Place your screw on top of the scale to identify their size.

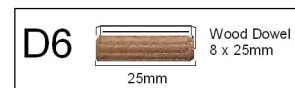
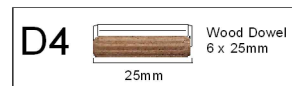
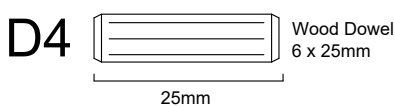
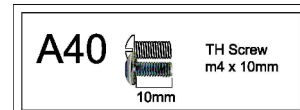
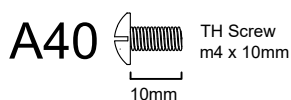
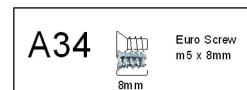
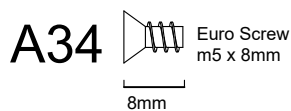
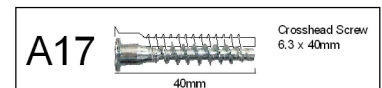
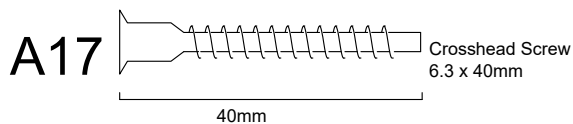
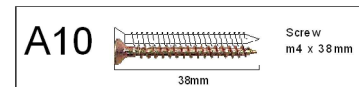
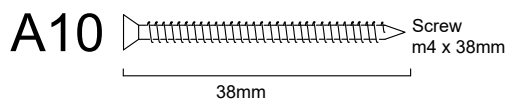
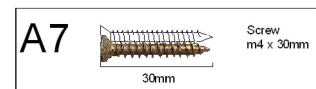
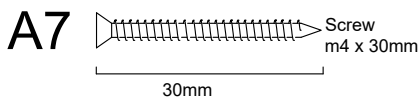
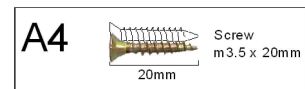
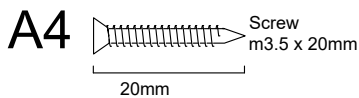
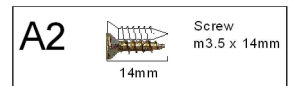
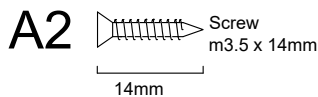
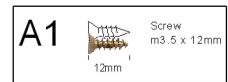
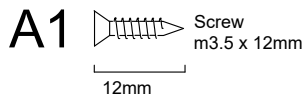

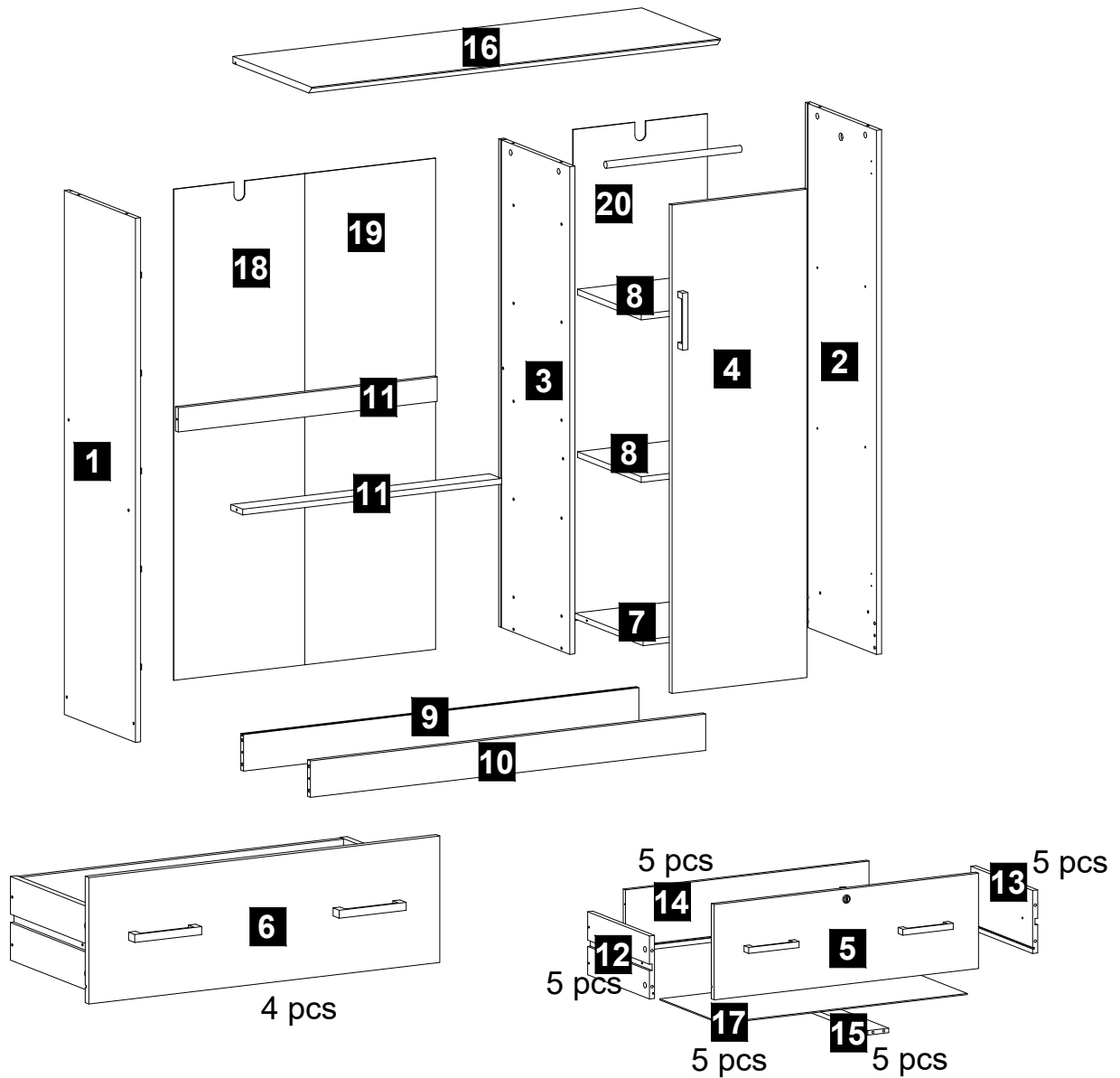

Parts List		
1	Side Panel (L)	1 pc
2	Side Panel (R)	1 pc
3	Center Panel	1 pc
4	Door Panel	1 pc
5	Drawer Front Panel (Lock)	1 pc
6	Drawer Front Panel	4 pcs
7	Bottom Panel	1 pc
8	Shelf Panel	2 pcs
9	Big Crossbar	1 pc
10	Big Crossbar Panel	1 pc

11	Small Crossbar	2 pcs
12	Drawer Side Panel (L)	5 pcs
13	Drawer Side Panel (R)	5 pcs
14	Drawer Back Board	5 pcs
15	Drawer Crossbar	5 pcs
16	Top Panel	1 pc
17	Drawer Bottom Panel	5 pcs
18	Backboard	1 pc
19	Middle Backboard	1 pc
20	Small Backboard	1 pc

**\*EACH PART IS LABELLED ACCORDING TO THE PARTS LIST\***



Before starting assembly  
please verify if all parts and  
hardware are included

# STEP 1

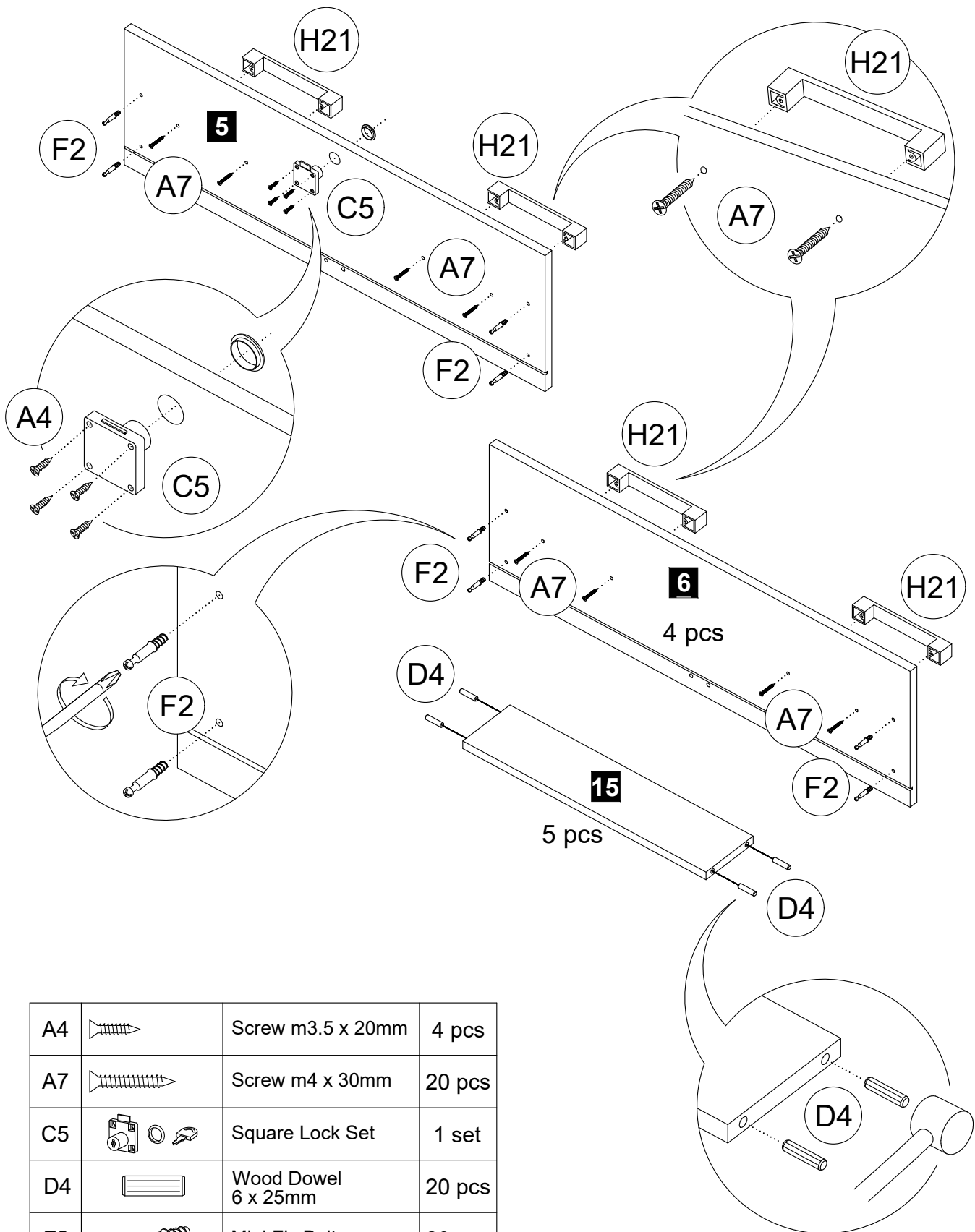

A4		Screw m3.5 x 20mm	4 pcs
A7		Screw m4 x 30mm	20 pcs
C5		Square Lock Set	1 set
D4		Wood Dowel 6 x 25mm	20 pcs
F2		Mini Fix Bolt	20 pcs
H21		Handle 128mm	10 pcs

# STEP 2

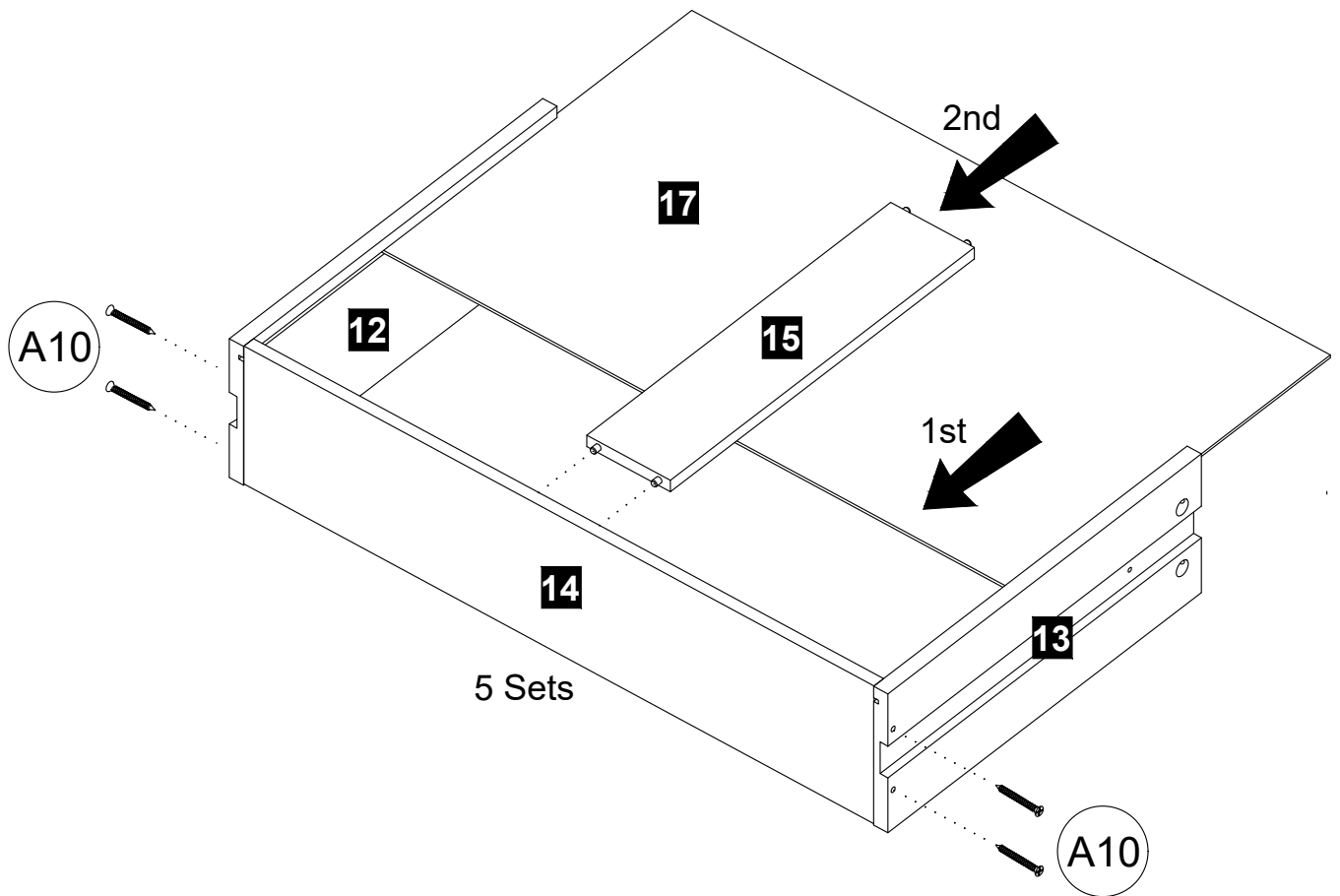

A10		Screw m4 x 38mm	20 pcs
-----	---	-----------------	--------

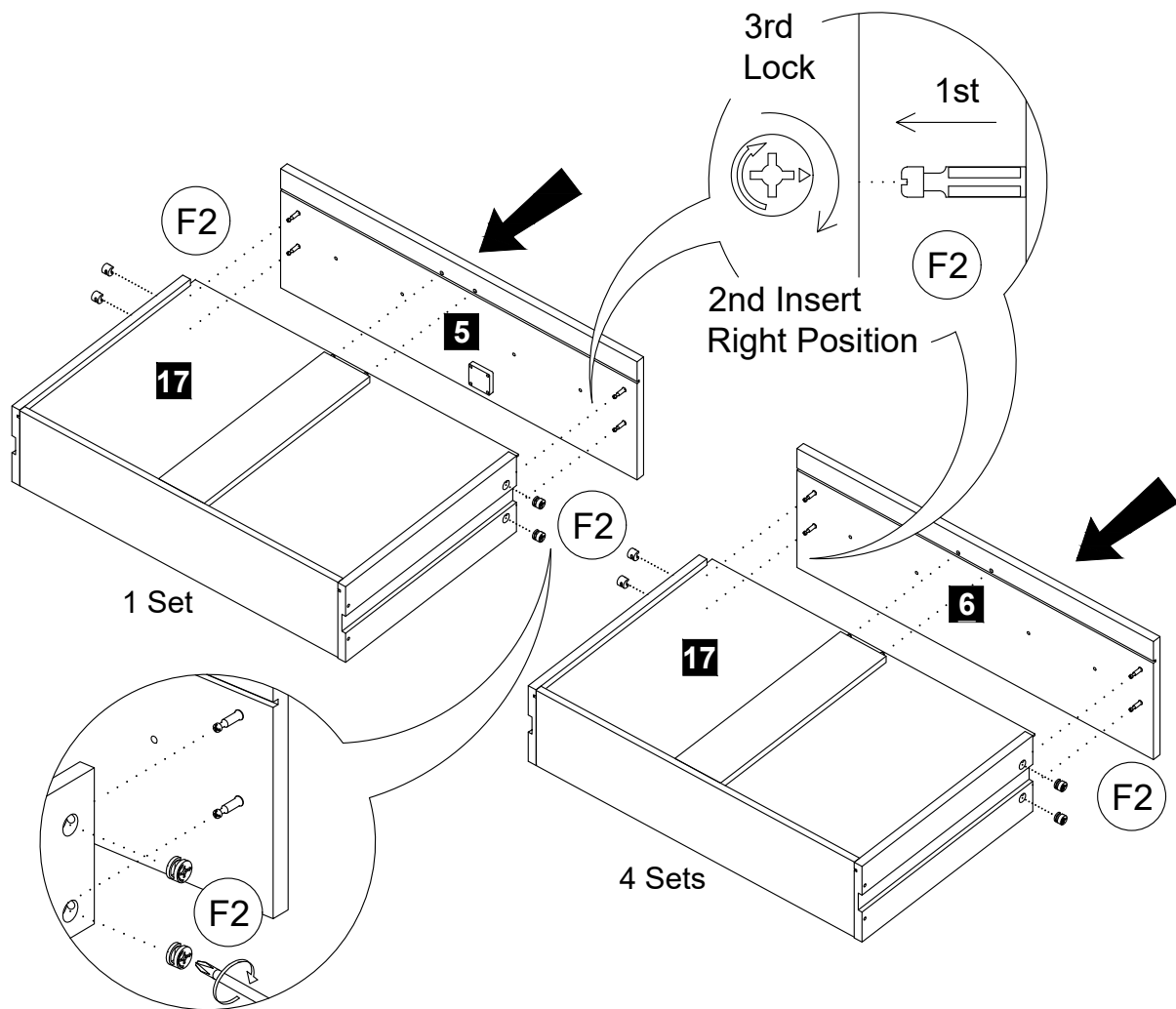

# STEP 3

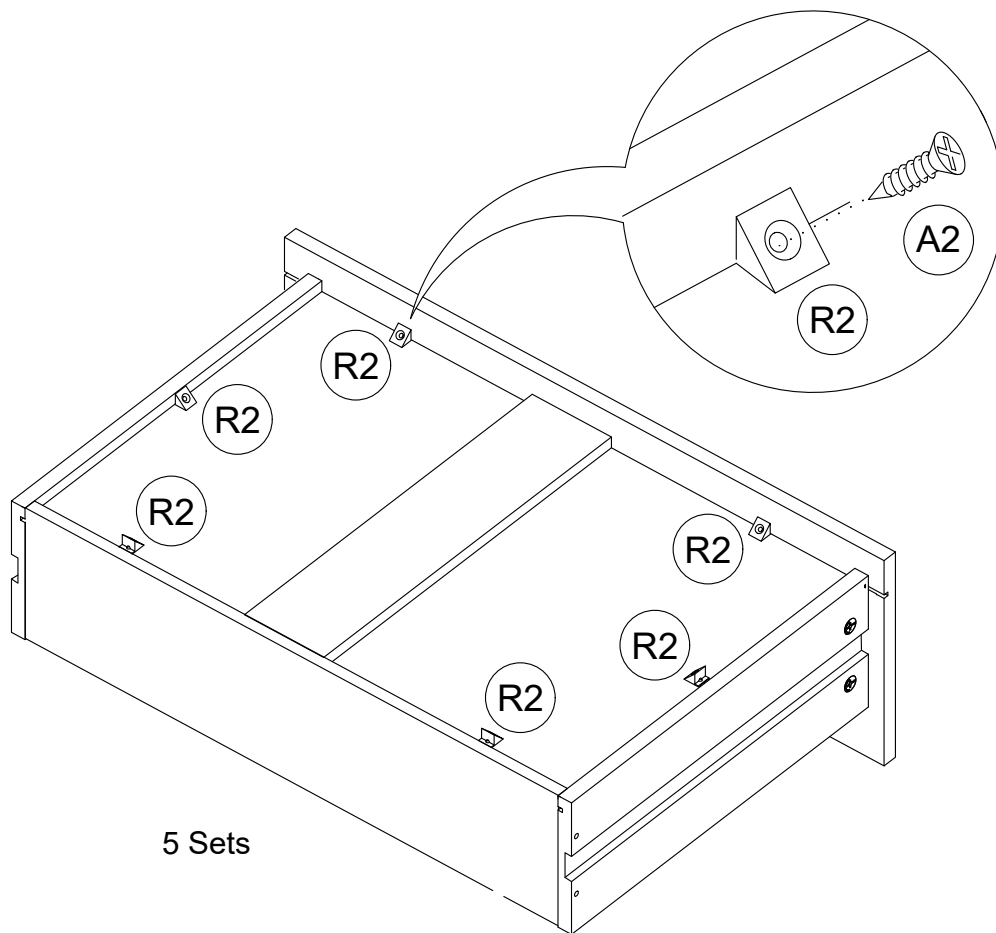

F2		Mini Fix 15mm	20 sets
----	---	---------------	---------

# STEP 4







A2		Screw m3.5 x 14mm	30 pcs
R2		Single Plastic Cap	30 pcs

# STEP 5

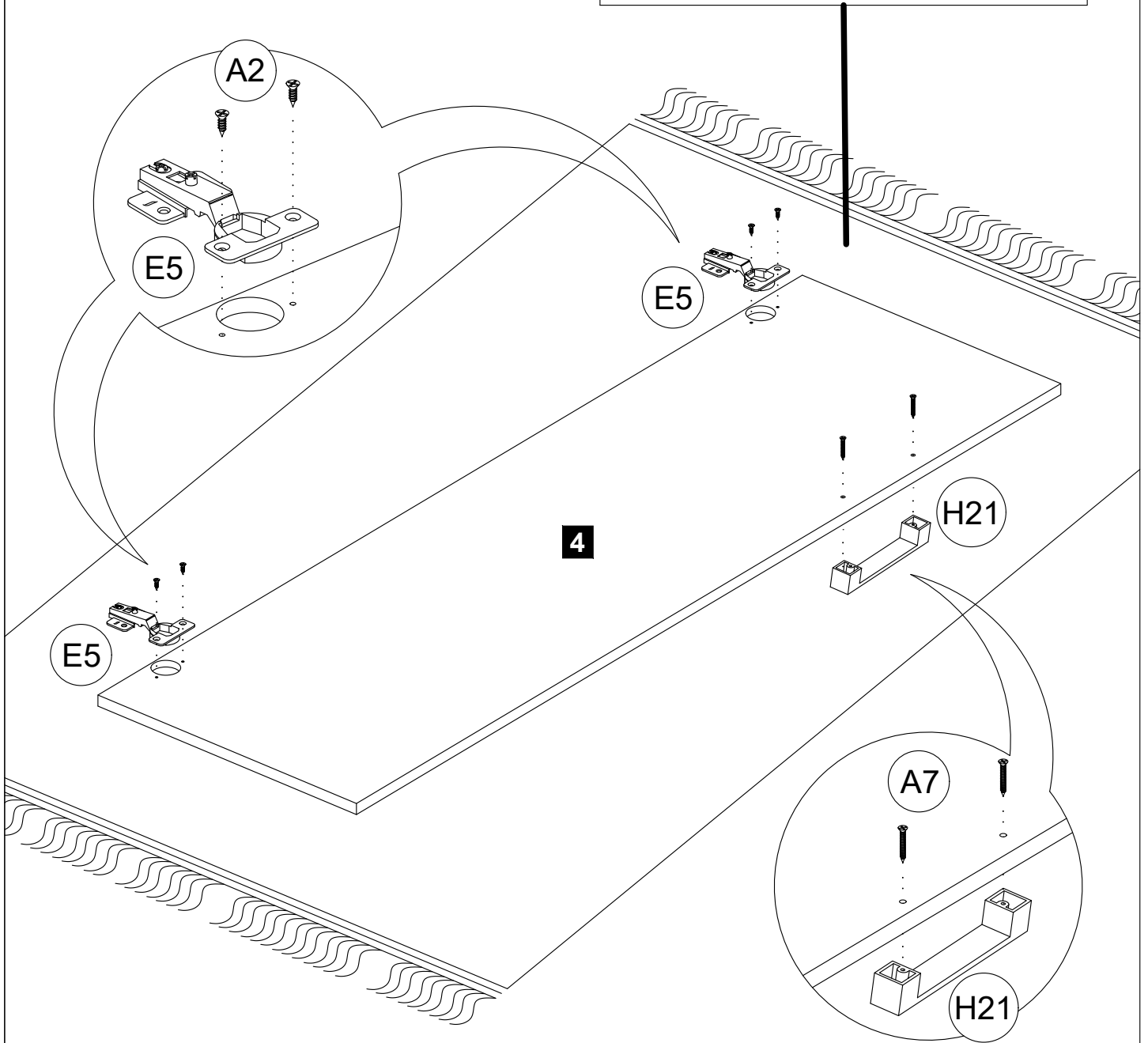
## ATTENTION !

Clean Surface / Rug  
before start assemble



A2		Screw m3.5 x 14mm	4 pcs
A7		Screw m4 x 30mm	2 pcs
E5		Soft Close Hinges 5/8"	2 pcs
H21		Handle 128mm	1 pc

# STEP 6



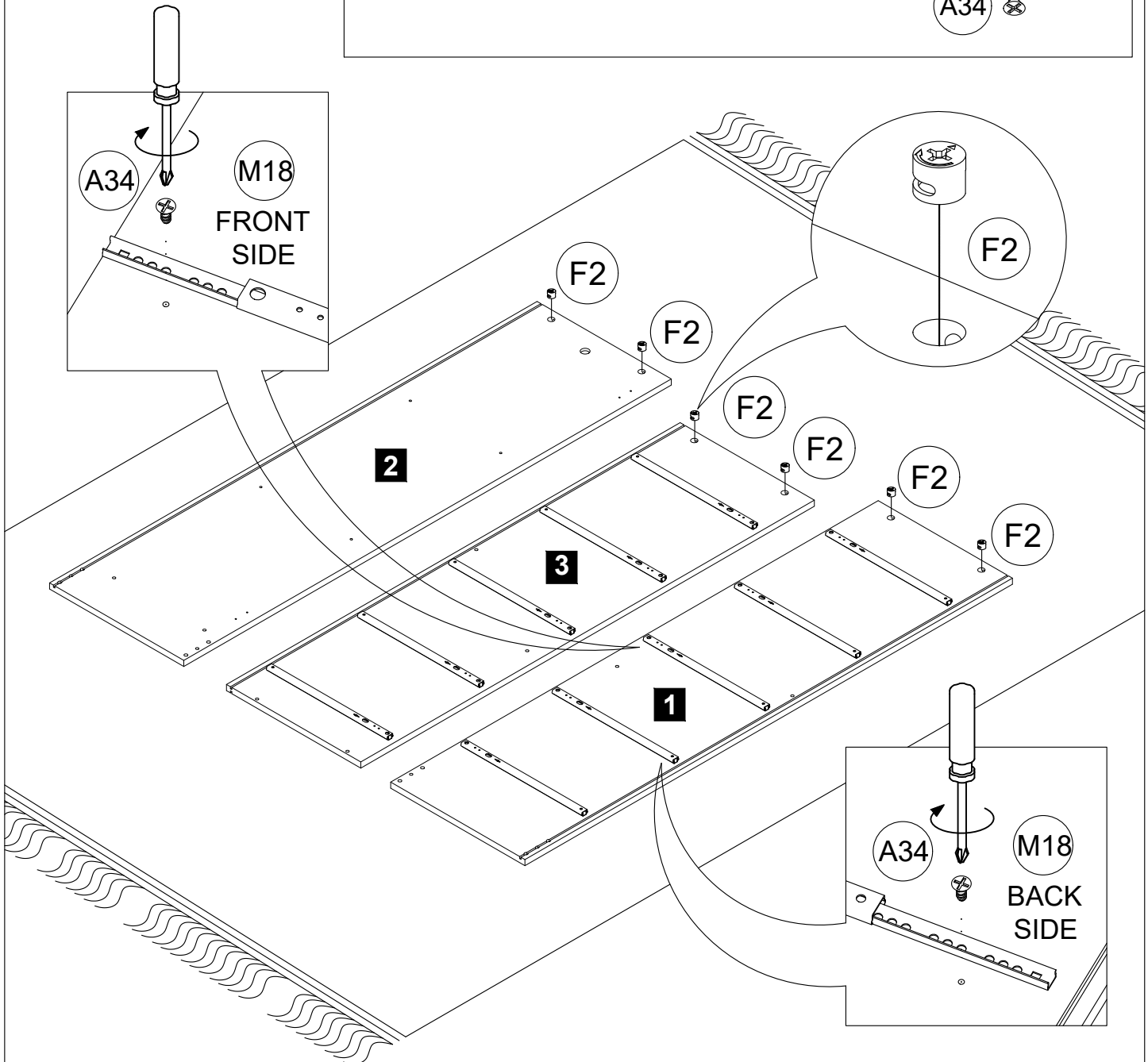
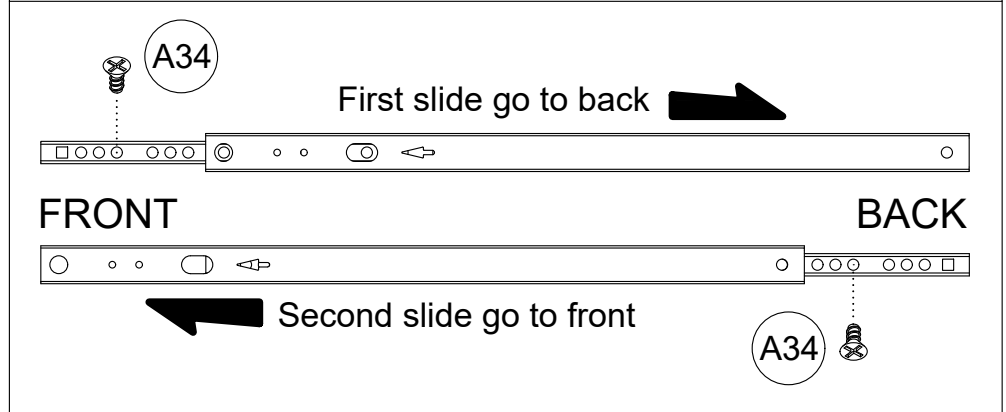



To Assemble the 2 Way Slide, Please follow step as below

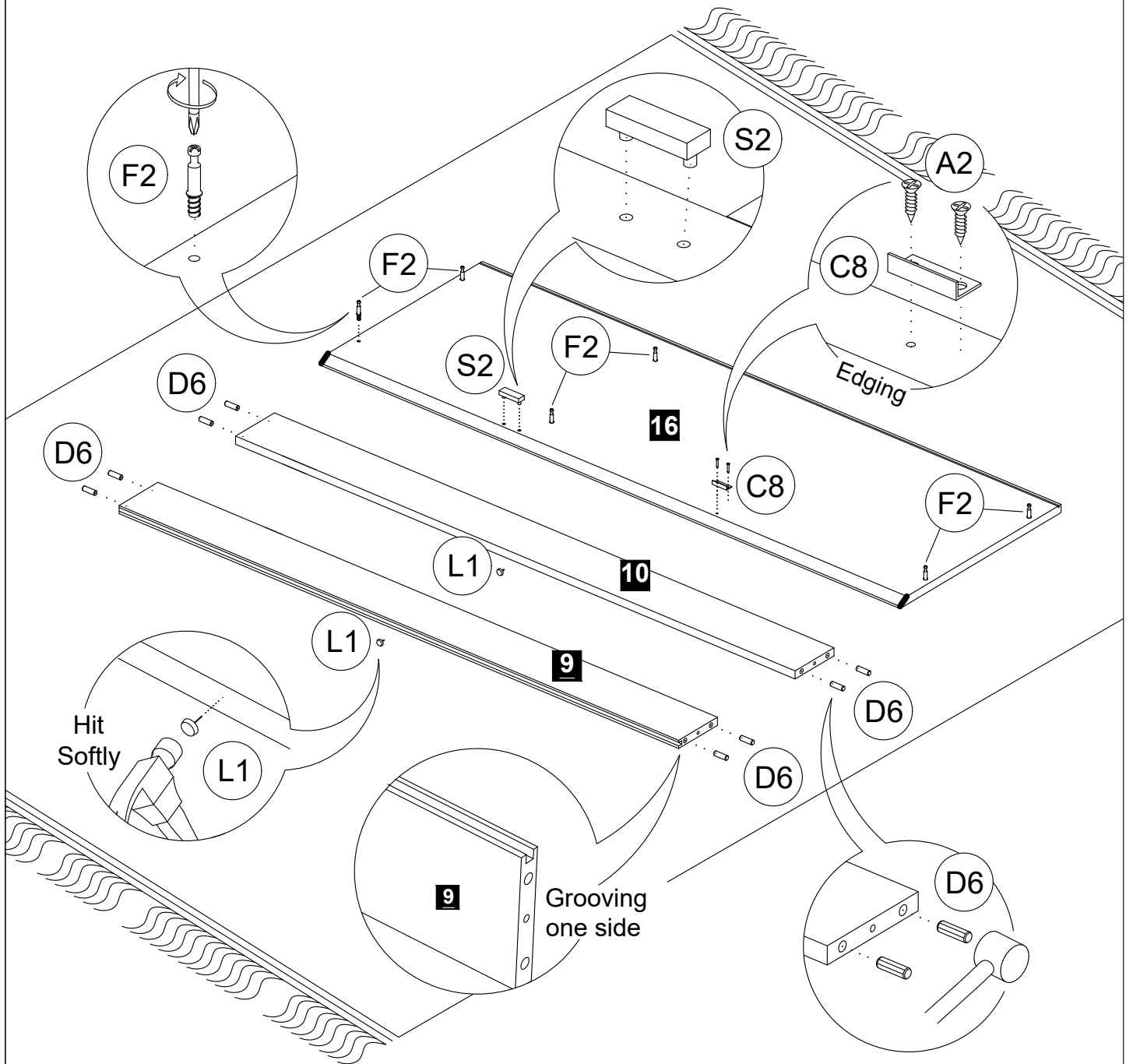

A34		Euro Screw m5 x 8mm	20 pcs
F2		Mini Fix Cam 15mm	6 pcs
M18		2 Way Slide_342mm	5 sets





# STEP 7

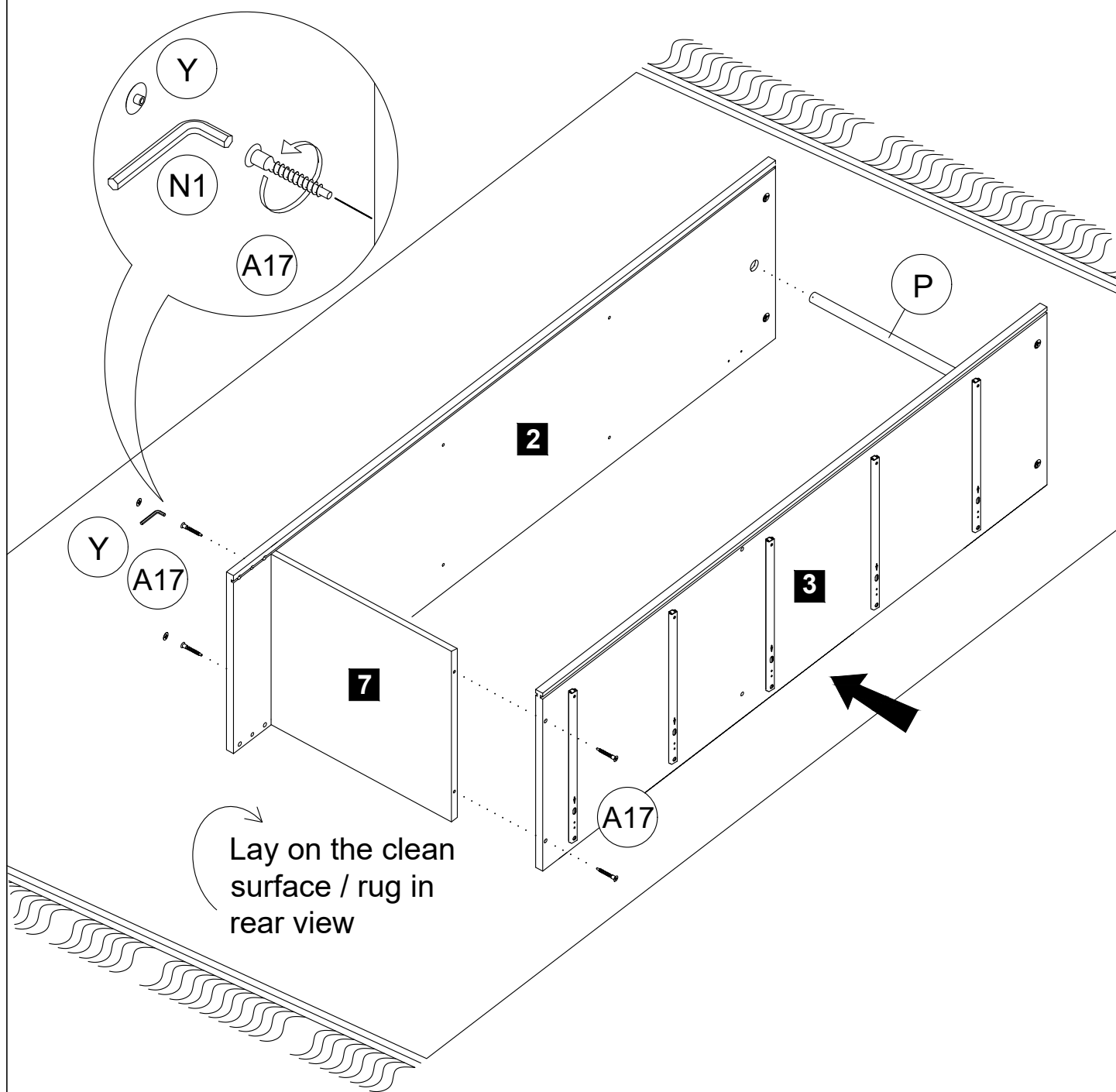

A2		Screw m3.5 x 14mm	2 pcs
C8		Square Lock Set	1 pc
D6		Wood Dowel 8 x 25mm	8 pcs
F2		Mini Fix Bolt	6 pcs
L1		Leg Pin	2 pcs
S2		Door Stopper	1 pc

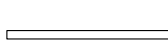

# STEP 8

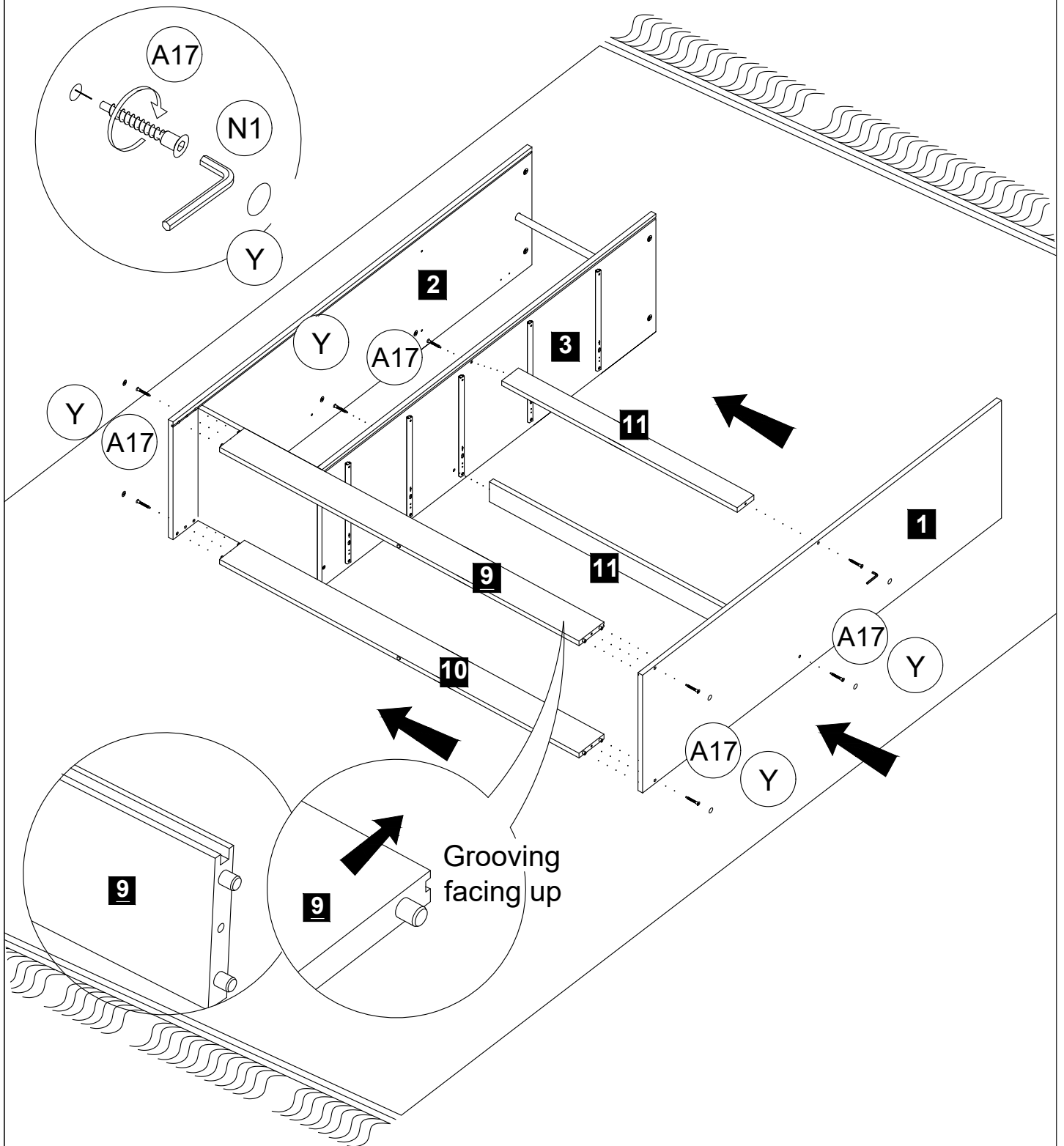

A17		Crosshead Screw m6.3 x 40mm	4 pcs
N1		Allen Key	1 pc
P		Hanging Steel Pipe 18mm x 396mm	1 pc
Y		Crosshead Cover	2 pcs

# STEP 9

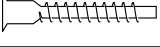

A17		Crosshead Screw m6.3 x 40mm	8 pcs
N1		Allen Key	1 pc
Y		Crosshead Cover	8 pcs

# STEP 10

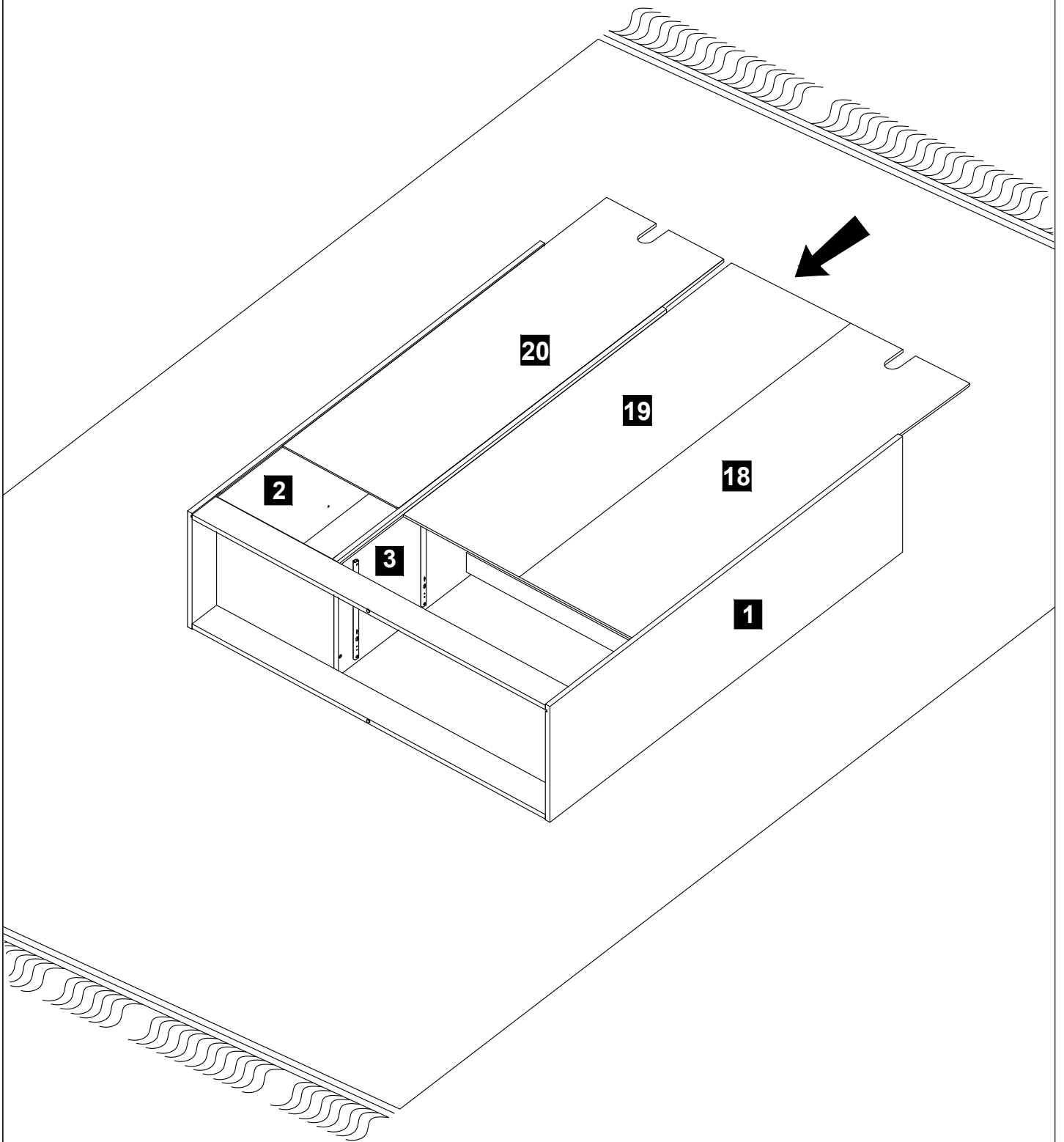



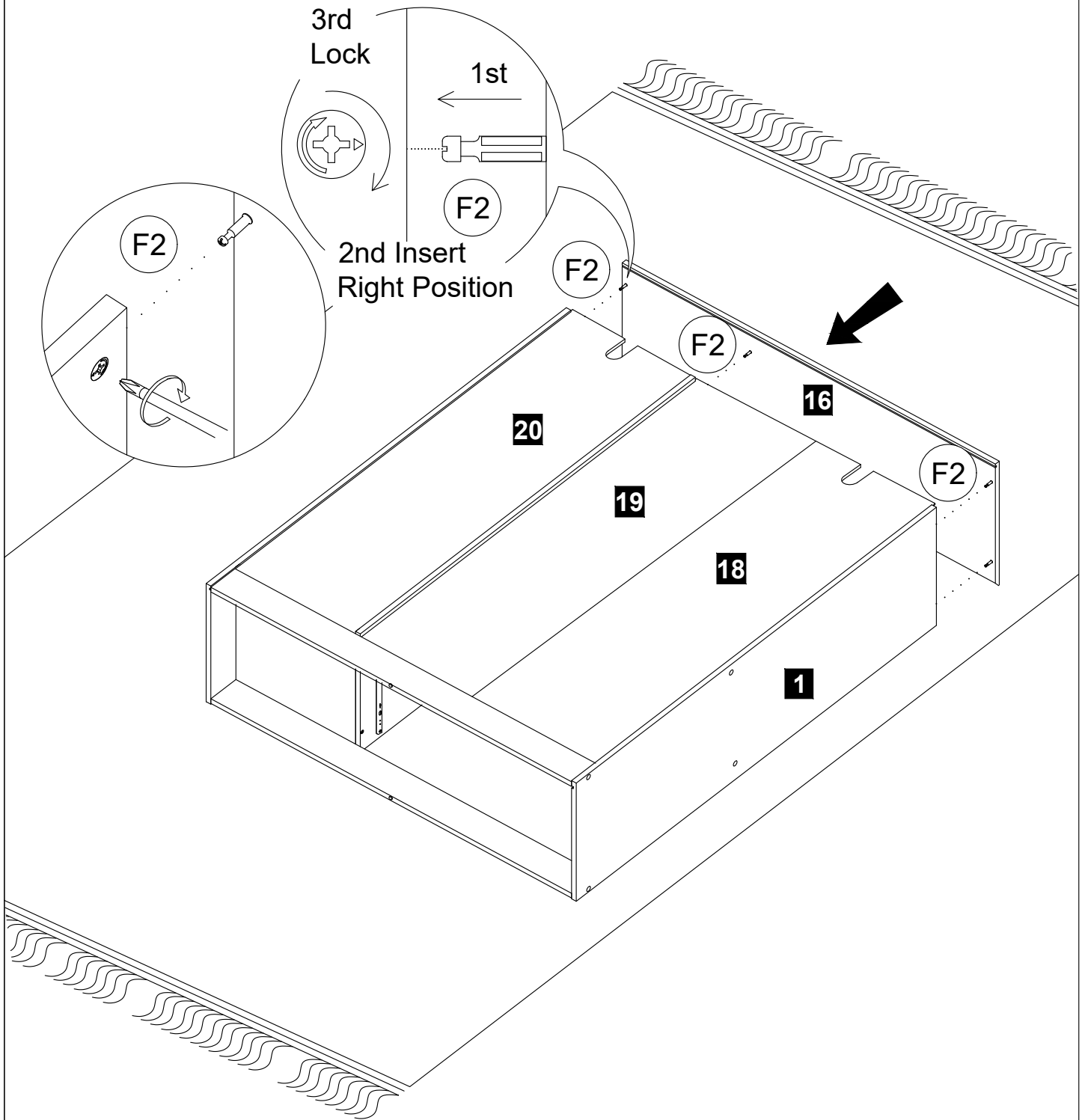

# STEP 11

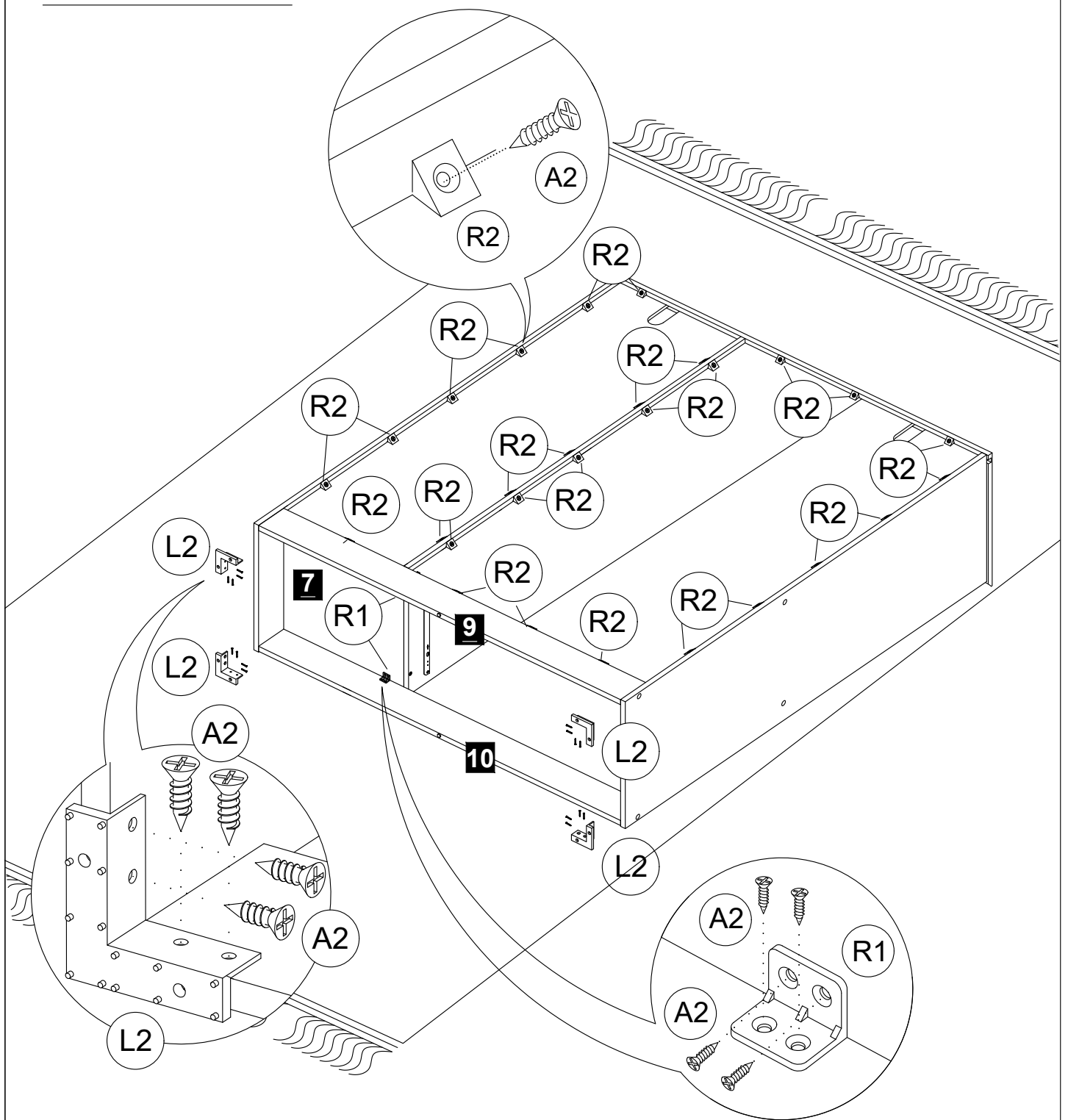

F2		Mini Fix 15mm	6 sets
----	---	---------------	--------

# STEP 12



A2		Screw m3.5 x 14mm	52 pcs
L2		Single Plastic Cap	4 pcs
R1		L-Bracket	2 pcs
R2		Single Plastic Cap	28 pcs

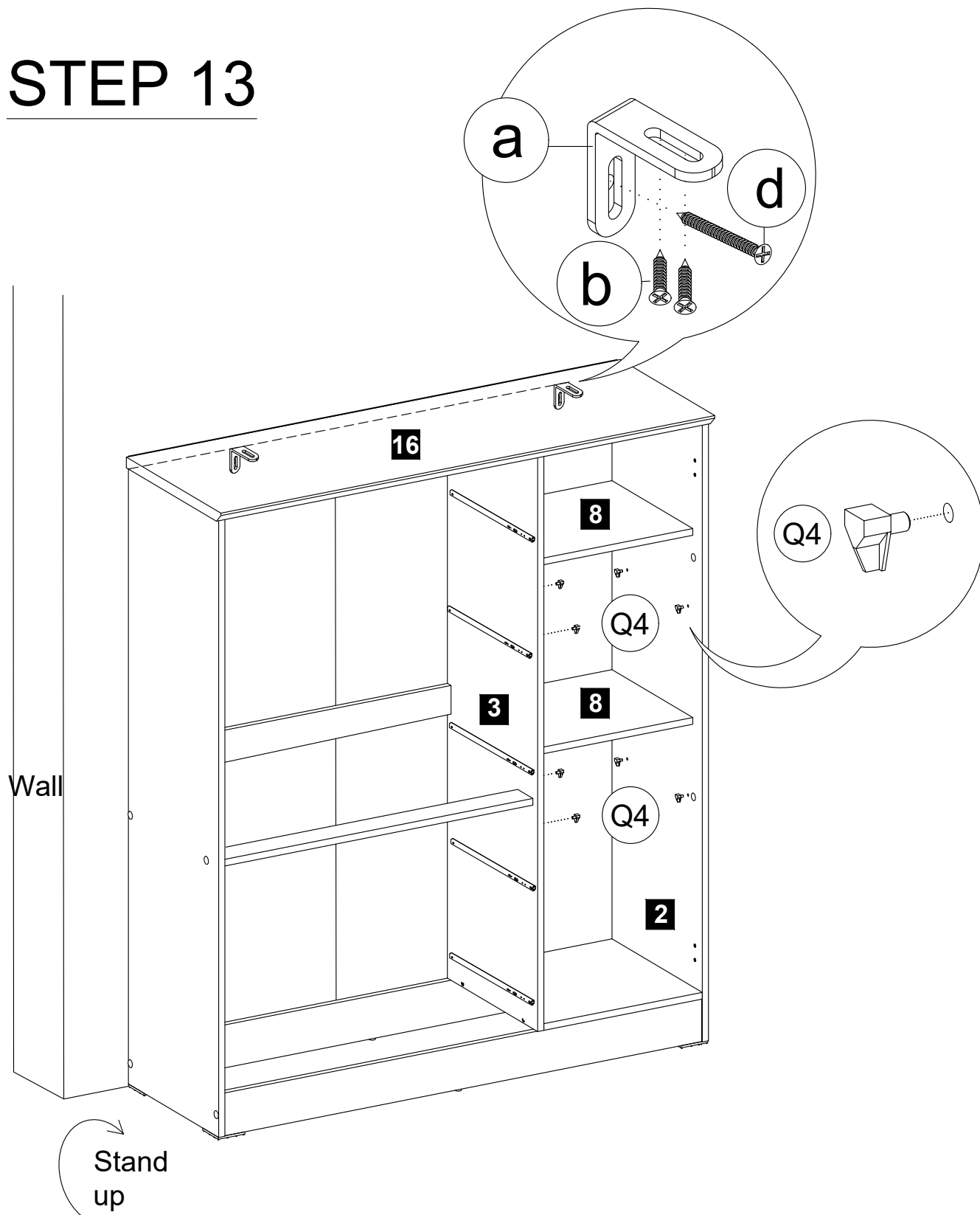

# STEP 13

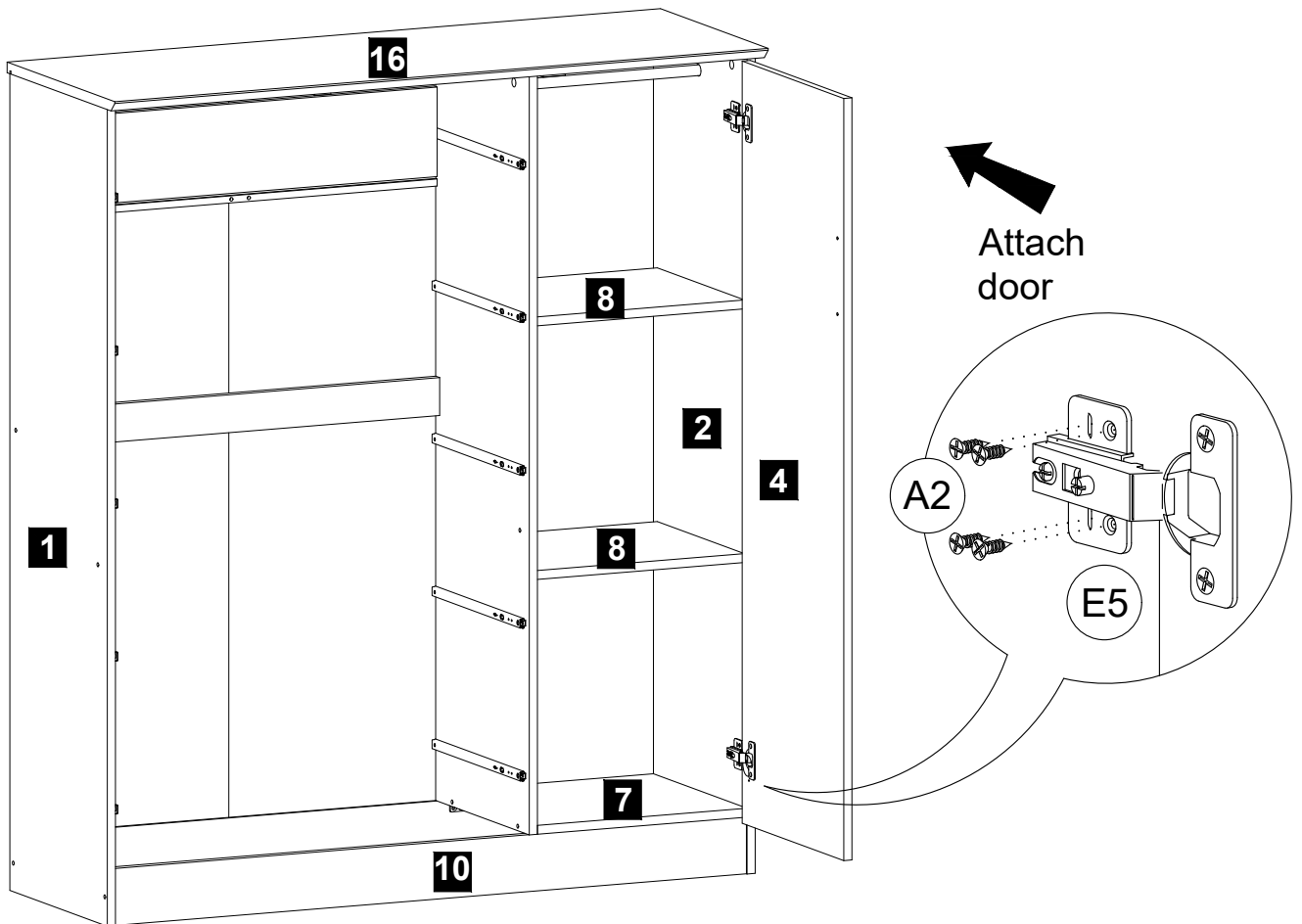

Q4		Plastic Shelf Support with Steel Pin	8 pcs
E21	a	Mounting Bracket	2 pcs
	b	Screw m3.5 x 20mm	4 pcs
	d	Screw m4 x 45mm	2 pcs

# STEP 14



A2		Screw m3.5 x 14mm	8 pcs
E5		Soft Close Hinges 5/8	2 pcs

# STEP 15

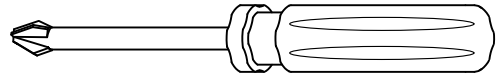

Please use Philips tip insert

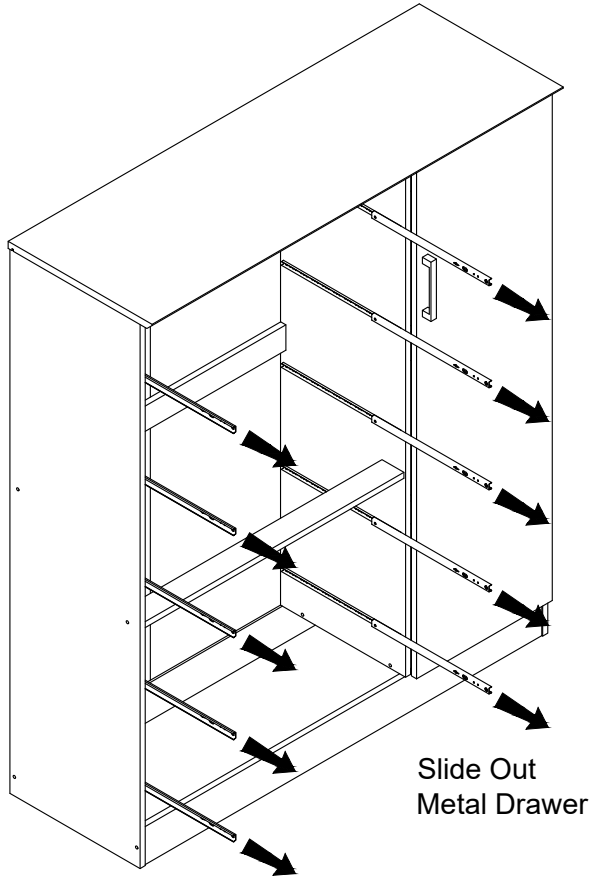

Slide Out  
Metal Drawer

Slide Out  
Metal Drawer

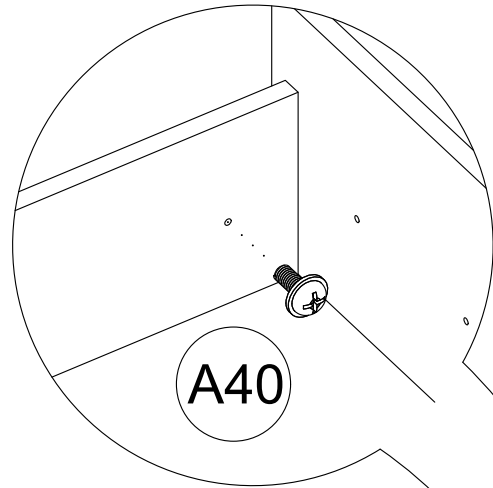

A40

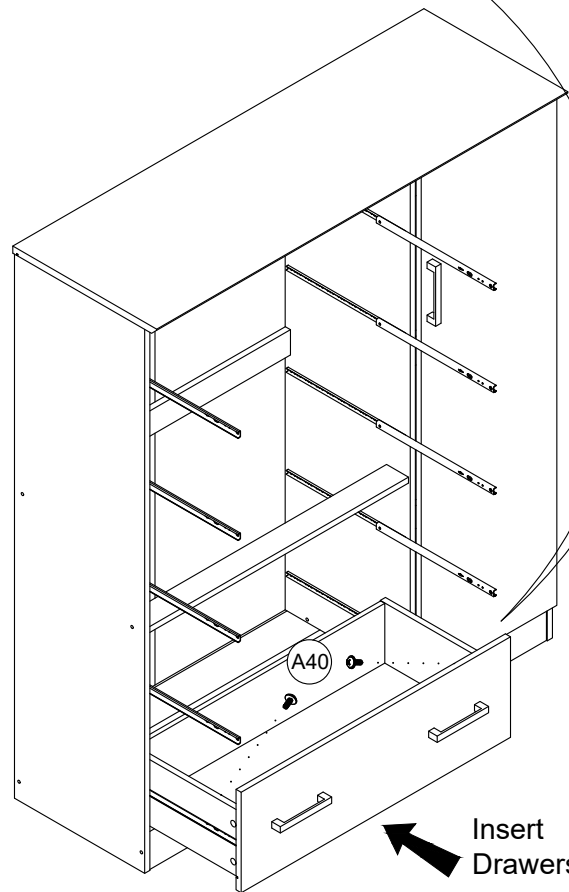

Insert  
Drawers

5 Sets  
Drawers

A40



Screw m4 x 10mm

10 pcs

# INSTALLATION OF TIPOVER RESTRAINT KIT

The Tipover Restraint Kit is highly recommended for this piece of furniture.

**(Please take this into extra consideration around young toddlers and children)**

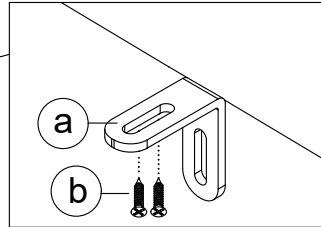
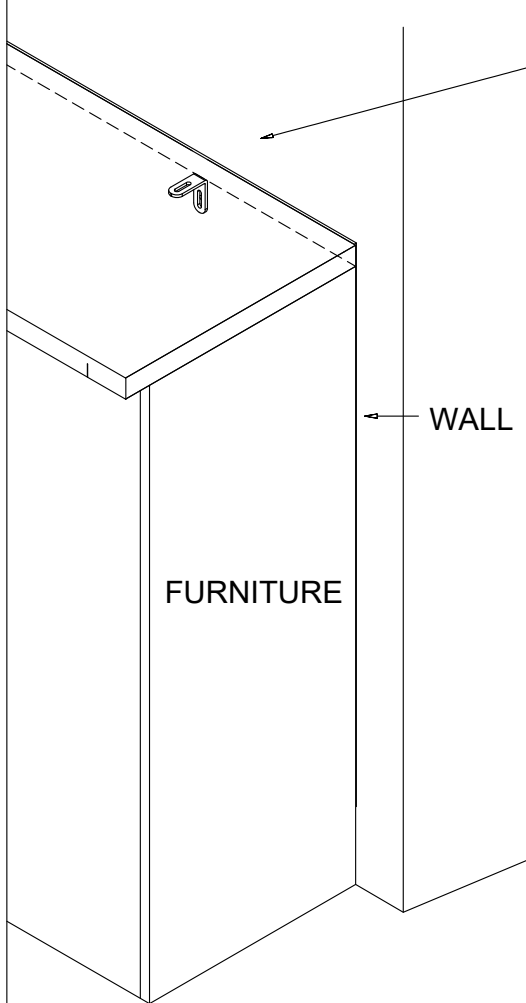

## STEP 1:

- Attach the mounting bracket (a) to the bottom top panel near the edge of the side of the unit.
- Screw (b) through the two holes of (a).

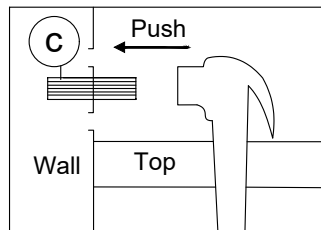

## STEP 2:

- Insert the wall plug (c) into the wall behind the unit.

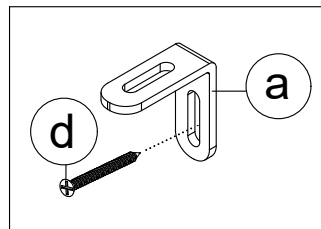

## STEP 3:

- Attach to the mounting bracket (a) to the wall plug (c) through the hole by using (d).

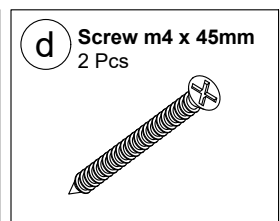
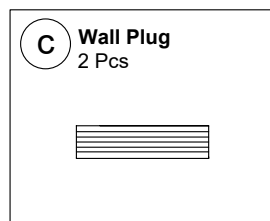
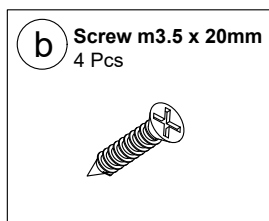
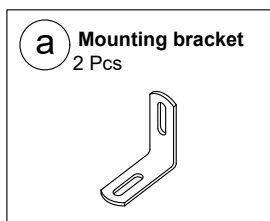

# DOOR ADJUSTMENT

## Up - Down

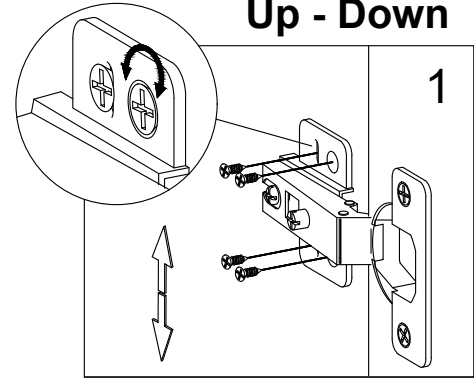
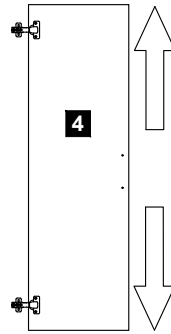

If the doors are not aligning move hinge up or down

## Left - Right

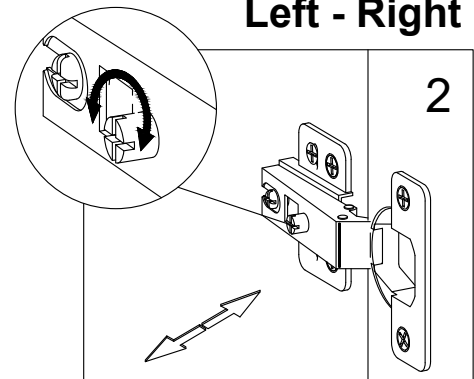
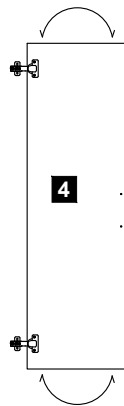

-If doors are over lapping each other or not parallel.  
-If the gap between the doors is too large or too small.

## In - Out

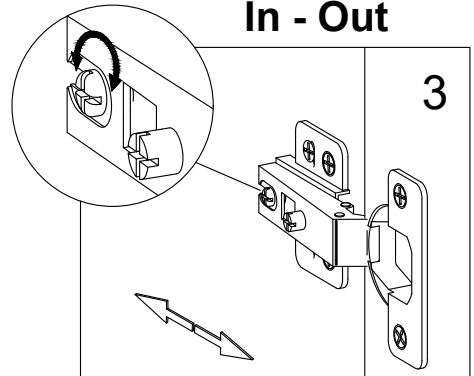
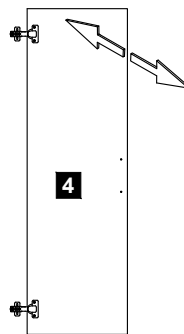

If the doors are rubbing against the sides of the closet move them away to increase the swing of the door.

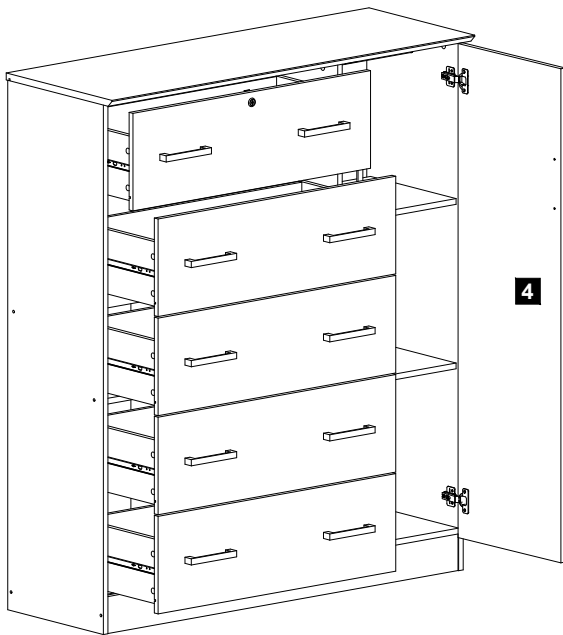

# Troubleshooting

- If the drawers are overlapping each other - **Solution:** The metal slides are placed upside down, please refer to the instruction manual.
- If the doors are overlapping each other - **Solution:** make sure the correct hinges are placed on the right door refer to the hinge assembly step on the manual.
- If the gap between the doors is too large or too small, the doors are overlapping each other, not parallel, or rubbing against the sides of the closet - **Solution:** See the page for " Door Adjustment. "

# **THANK YOU**

**We hope you enjoy your new purchase.**

**We have personally inspected this product.**

**In the event that you need any additional help for any reason,**

**Please do not hesitate to contact us.**

**Thank you**