

ASSEMBLY INSTRUCTIONS

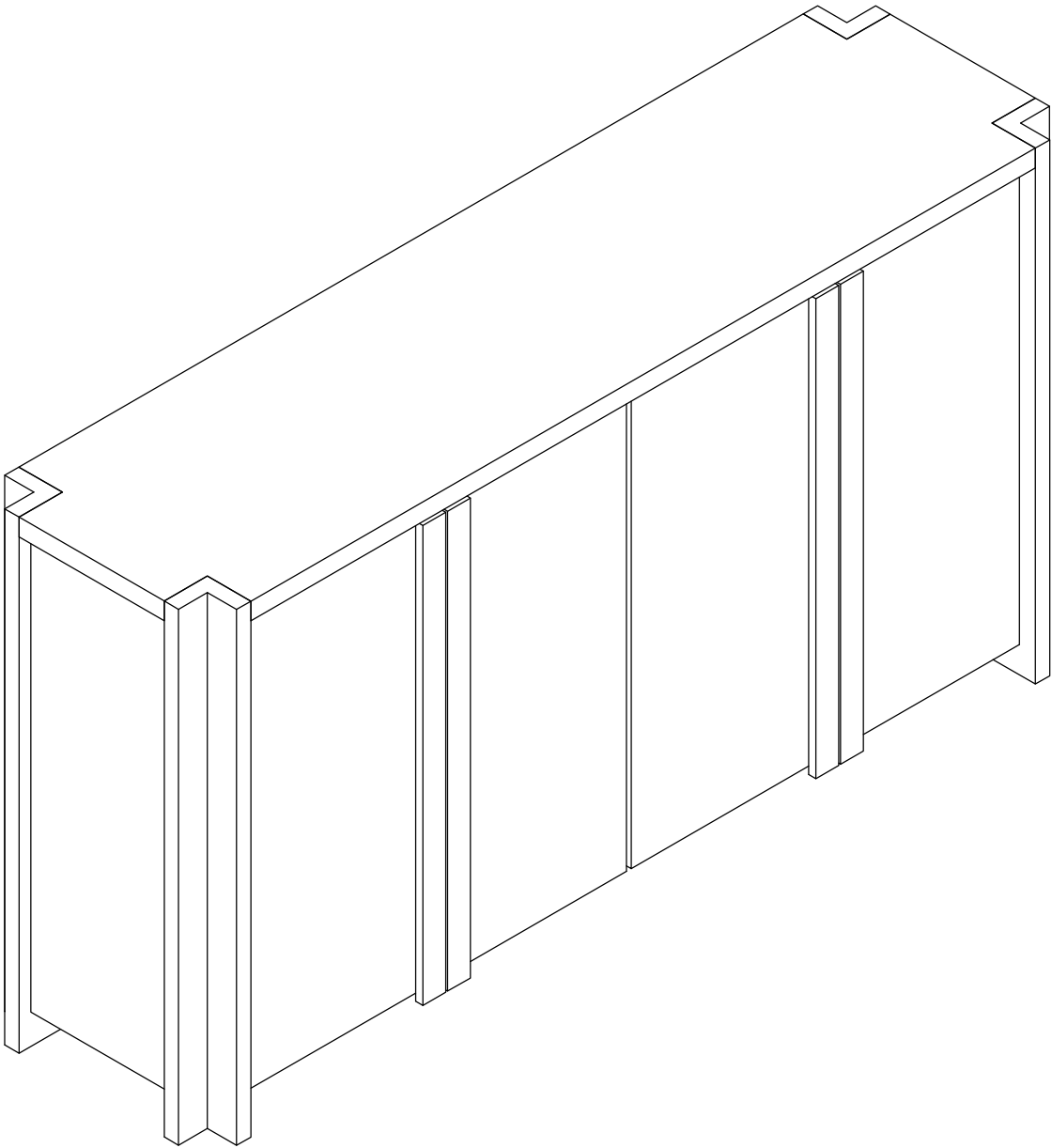

1. Thank you for choosing *our products*.

2. Return Policy







DO NOT RETURN TO THE STORE! Skip the process of returning your product and contact us directly for a replacement

If you find that parts of your order are missing or damaged, we will gladly ship any needed replacement parts free of charge.

If your product's quality does not meet your expectations or you have found any sort of defect, please contact our customer service department and let us know the details of your order and any issues encountered, we will try our best to provide you with a solution. Feel free to also directly contact our manufacturer at wftteam@comptree.net concerning needed replacement parts and they will be happy to help provide you with a solution or answer any questions you may have.







Recommendations Before Beginning Assembly







-  • Read instructions, cover to cover
-  • Have 2-4 adults on hand for assembly depending on product size
-  • Do not assemble directly on flooring or carpet
-  • Assemble on a clean non-marring surface (example: packing foam)
-  • Save all packaging until finished

3. Assembly Notice:

- If you encounter any problems during assembly and find that you cannot continue, rest assured we will help you solve the situation as soon as possible. Simply keep all of the parts of the product stored in a safe place and contact us immediately so we may assist you further.
- Once you have opened your package, remove all inner hardware packages and take the parts out. One by one, Place the parts out neatly in front of you, then refer to the instructions to ensure no parts are missing. If any pieces are found missing, please carefully look in the box first, as the hardware packaging might have torn making the hardware spill in the box.
- Some key parts of your product may be stored and hidden inside of other parts. Please open any zippered or hook & loop storage compartments to remove all parts. (example: cushions and legs being stored in the underside of a sofa)
- **IMPORTANT:** When setting up your product, **DO NOT INSTALL THE SCREWS ALL THE WAY IN THE BEGINNING.** Place each screw into their proper hole and use your hand to twist the screw halfway. Twist all the screws in halfway to ensure the holes will match up properly and the product is level on the ground. When everything seems fitted, then tighten the screws.
- When you have completed assembly, we suggest you have more than one person to assist you with lifting and placing the product.

Care & Maintenance

-  • Do not put hot items directly on furniture surface
-  • Do not clean furniture with harsh cleansers or polish
-  • Do not place furniture under direct sunlight
-  • Do not place furniture near heating or cooling vents
-  • Do not write on furniture without a padded barrier to protect the surface
-  • Do not place furniture outside. For indoor use only
-  • Not for commercial use. For residential use only

-   Stains may be removed with mild soap solution and damp cloth
-   Children should not climb or jump on the furniture
-   Dust and pick-up spills using a clean, non-colored, lint-free cloth

Caution

- This product contains small components. Please ensure that they are kept away from small children.
- Do not use power tools to assemble your furniture. Power tools may strip or damage the parts.



ASSEMBLY INSTRUCTIONS

CABINET

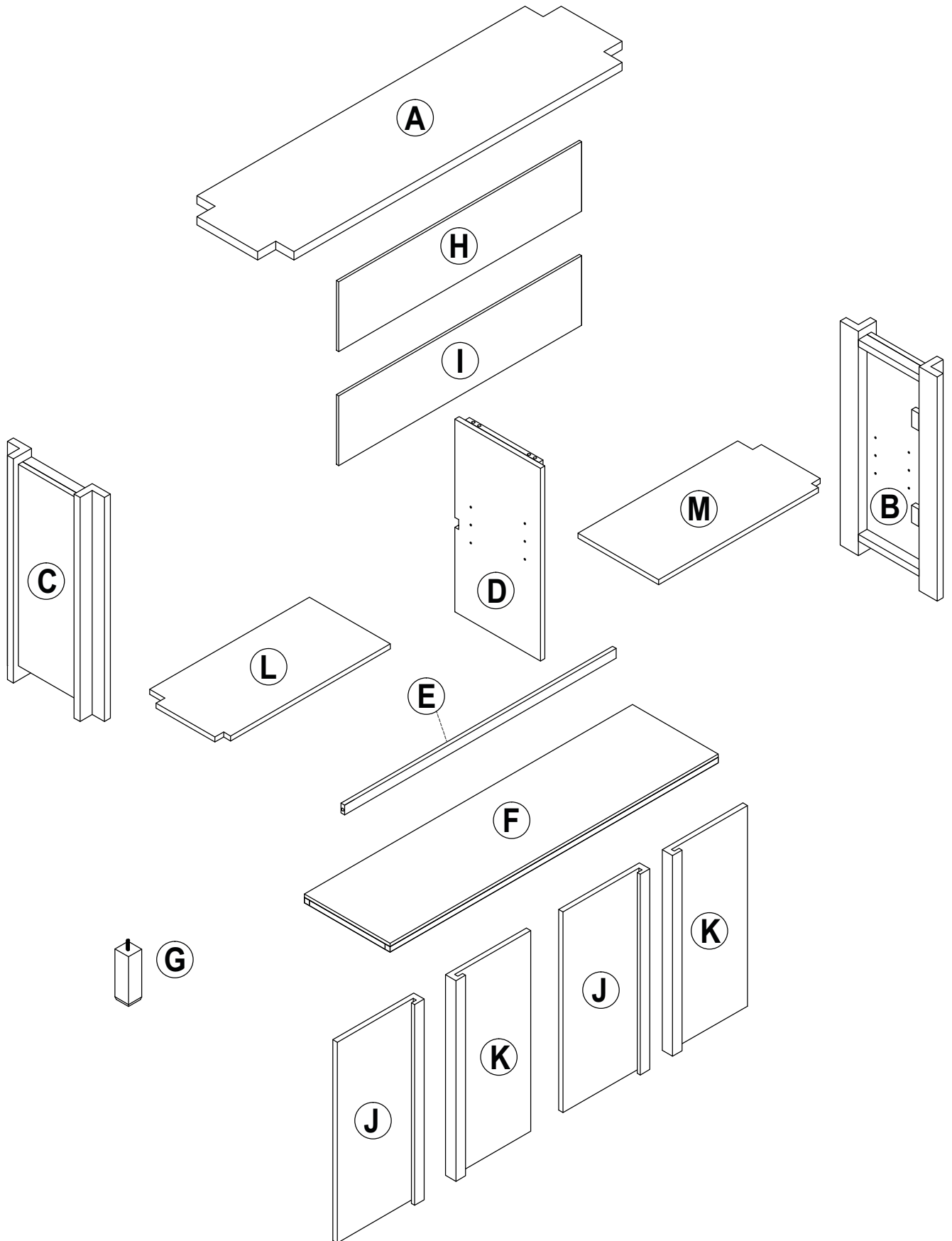

ASSEMBLY INSTRUCTIONS

CABINET

Important - Please read instructions fully before starting assembly

- . Check you have all the components and tools listed on the following pages
- . Remove all fittings from the plastic bags and separate them into their groups.
- . Keep children and animals away from the work area , small parts could choke if swallowed.
- . Make sure you have enough space to layout the before starting.
- . During assembly do not stand or put weight on the product this could cause damage.
- . Assembly the item as close to its final position (in the same room) as possible.
- . Assembly on a soft level surface to avoid damaging the unit or your floor.
- . Parts of the assembly will be easier with 2 people.
- . To reduce the likelihood of damaging your product please ensure that your power drill is set on a low torque setting.



power drill is set on a low torque setting.

Care and maintenance

- . Only clean using a damp cloth and mild detergent, do not use bleach or abrasive cleaners.
- . From time to time check that there are no loose screws on this unit.
- . This product not be discarded with household waste Take to your local authority waste disposal centre.

Handy Hints

- . Assembly all parts and bolts loosely during assembly only once the product is complete should fully tighten the bolts.
- . Regularly check and ensure that all bolts and fittings are tightend properly.

WARNING

In order to help prevent overturning - please follow these instructions

To help prevent product toppling over please follow the below steps.

Use the anti tip stap or wan fixing method provided (if applicable)

Do not allow children to climb or hang on the funiture

Do not open more than one drawer at a time

Do not place heavy items in the top drawers

Do not place heavy items on top of the furniture, unless the furniture has been designed for this purpose

Please note that only anti tip strap in provided

You will need to provide wall plugs and screws applicable for your wall type

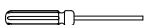

Tools required

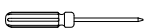

Screwdriver (medium & large)

Ruler - Use this ruler to help correctly identify the screws

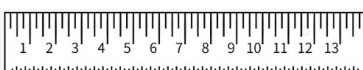





The screws length is measured from the head to the point

ASSEMBLY INSTRUCTIONS

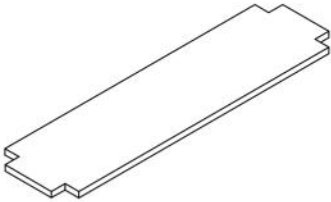
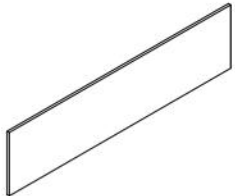
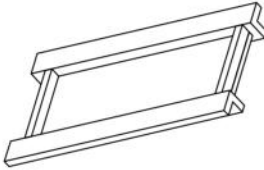
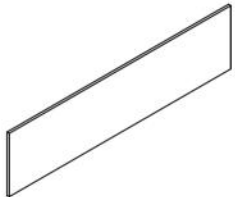
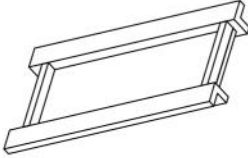
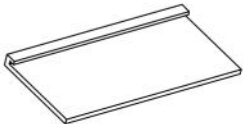
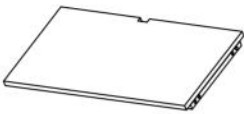
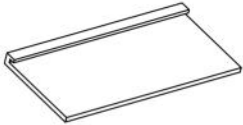
CABINET

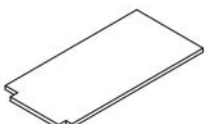

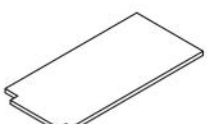
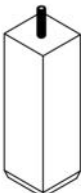











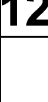

Part List

A TOP PANEL - 1PC 	H BACK PANEL - 1PC 
B RIGHT PANEL - 1PC 	I BACK PANEL - 1PC 
C LEFT PANEL - 1PC 	J LEFT DOOR - 2PC 
D BETWEEN PANEL - 1PC 	K RIGHT DOOR - 2PC 
E REAR TIE ROD - 1PC 	L LEFT SHELF - 1PC 
F BOTTOM - 1PC 	M RIGHT SHELF - 1PC 
G MIDDLE LEG - 1PC 	

ASSEMBLY INSTRUCTIONS

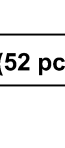
CABINET

Hardware List





<p>1</p>  <p>1/4"x45mm</p> <p>Hex-Head Bolts (12 pcs)</p>	<p>9</p>  <p>Ø4 x 38mm</p> <p>Umbrella Head Screw (2 pcs)</p>
<p>2</p>  <p>5/16"x13x1.5mm</p> <p>Spring Washer (12 pcs)</p>	<p>10</p>  <p>Ø4 x 15mm</p> <p>Umbrella Head Screw (52 pcs)</p>
<p>3</p>  <p>5/16"x16x1.5mm</p> <p>Flat Washer (12 pcs)</p>	<p>11</p>  <p>Ø4 x 15mm</p> <p>Flat Head Screw (56 pcs)</p>
<p>4</p>  <p>Allen Key (1 pc)</p>	<p>12.1</p>  <p>Patch L (2 pcs)</p>
<p>5</p>  <p>Shelf pin (8 pcs)</p>	<p>12.2</p>  <p>Ancho (1 pc)</p>
<p>6</p>  <p>Wooden Pegs (12 pcs)</p>	<p>12.3</p>  <p>Plastic Strap (1 pc)</p>
<p>7A</p>  <p>Damper Hinge (4 pcs)</p>	<p>7B</p>  <p>Damper Hinge (4 pcs)</p>
<p>8</p>  <p>Ø4 x 25mm</p> <p>Umbrella Screw (1 pc)</p>	<p>12.4</p>  <p>Ø4 x 15mm</p> <p>Short Screw (1 pc)</p>
	<p>12.5</p>  <p>Ø4 x 50mm</p> <p>Long Screw (1 pc)</p>

ASSEMBLY INSTRUCTIONS

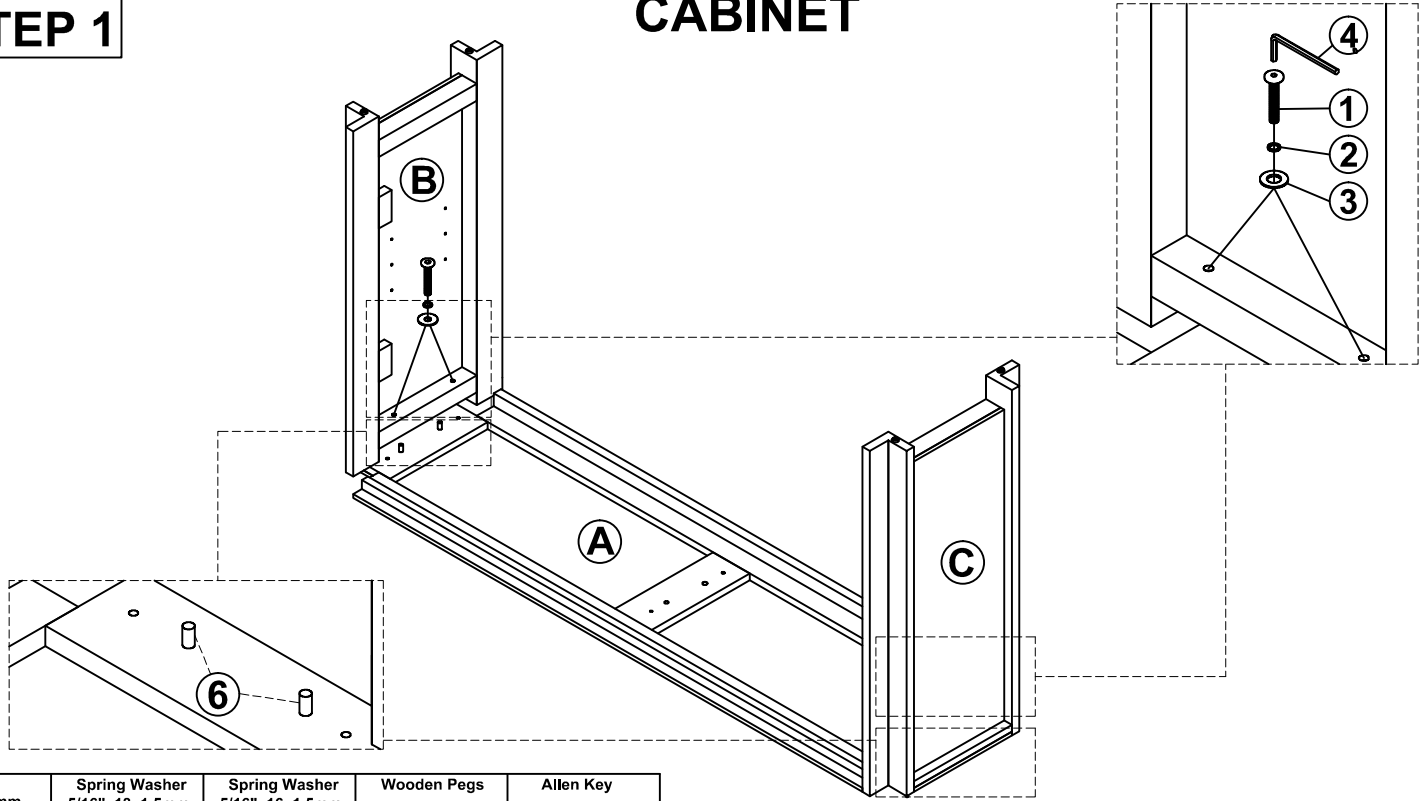
CABINET





STEP 1

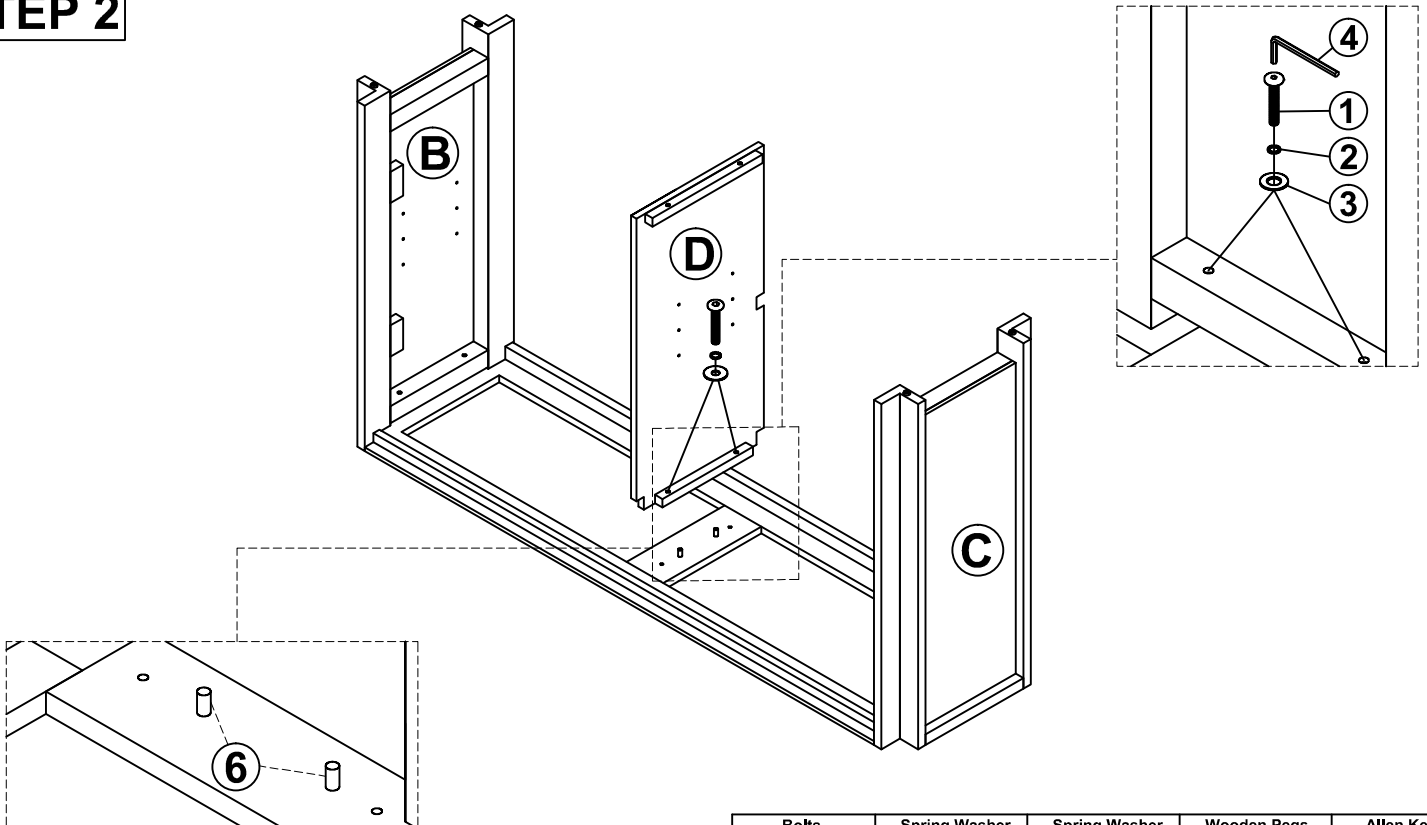

Bolts 1/4"x45mm  ① x 4	Spring Washer 5/16"x13x1.5mm  ② x 4	Spring Washer 5/16"x16x1.5mm  ③ x 4	Wooden Pegs  ⑥ x 4	Allen Key  ④ x 1
--------------------------------------------------------------------------------------------------------------------------	----------------------------------------------------------------------------------------------------------------------------------------	----------------------------------------------------------------------------------------------------------------------------------------	--------------------------------------------------------------------------------------------------------------------	------------------------------------------------------------------------------------------------------------------

STEP 2





Bolts 1/4"x45mm  ① x 2	Spring Washer 5/16"x13x1.5mm  ② x 2	Spring Washer 5/16"x16x1.5mm  ③ x 2	Wooden Pegs  ⑥ x 2	Allen Key  ④ x 1
---------------------------------------------------------------------------------------------------------------------------	------------------------------------------------------------------------------------------------------------------------------------------	------------------------------------------------------------------------------------------------------------------------------------------	----------------------------------------------------------------------------------------------------------------------	--------------------------------------------------------------------------------------------------------------------

ASSEMBLY INSTRUCTIONS

CABINET

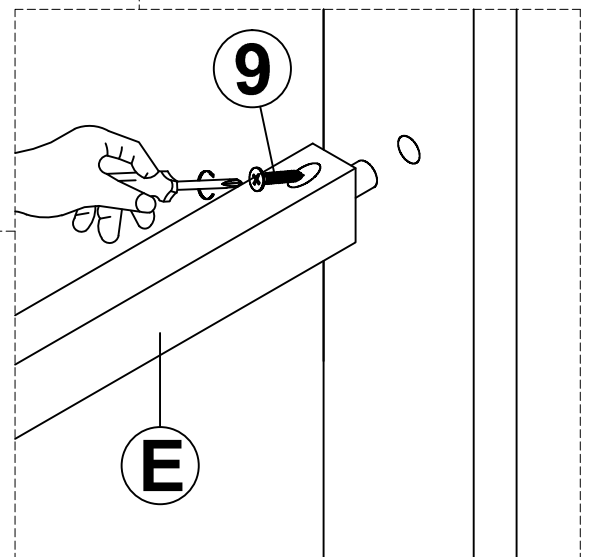
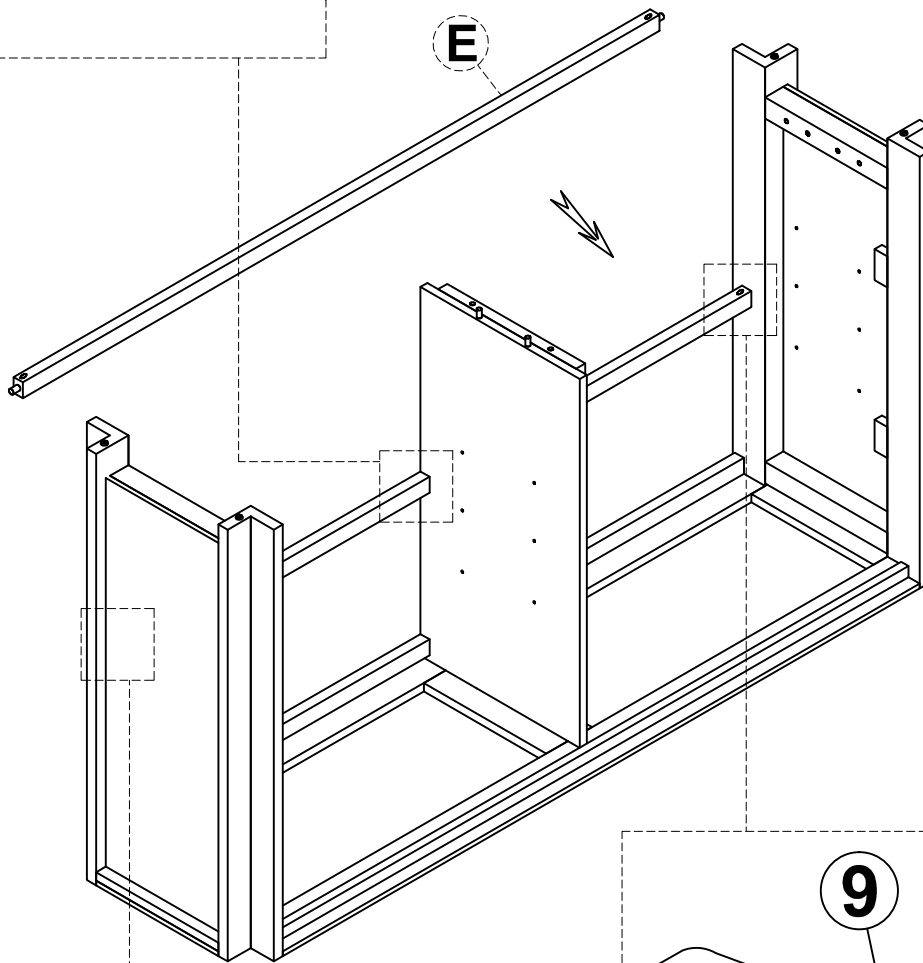
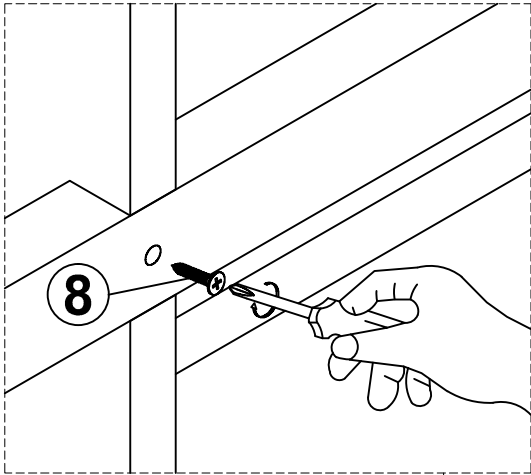
STEP 3



SCREW 4x25mm (Umbrella head screw)	SCREW 4x38mm (Umbrella head screw)
 ⑧ x1	 ⑨ x2

ASSEMBLY INSTRUCTIONS

CABINET

STEP 4

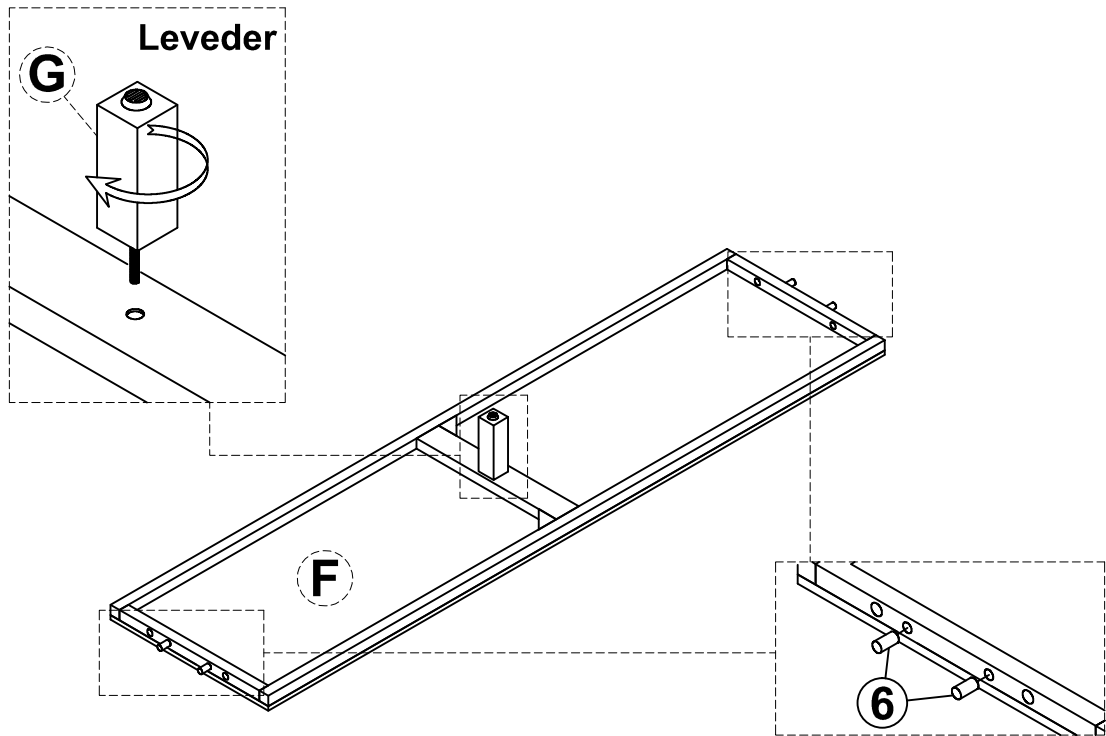

Wooden Pegs



⑥ x 4

STEP 5

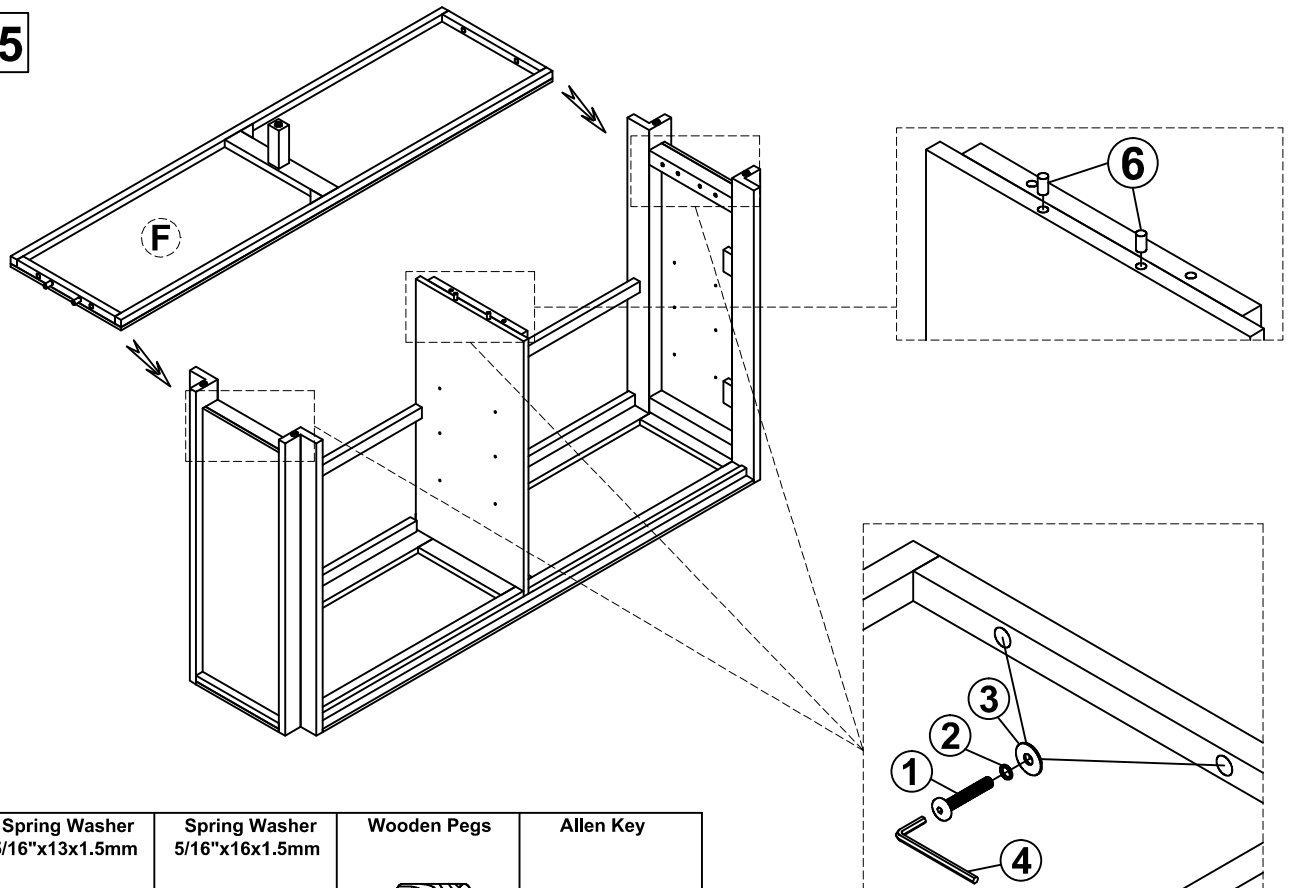

Bolts
1/4"x45mm



① x 6

Spring Washer
5/16"x13x1.5mm



② x 6

Spring Washer
5/16"x16x1.5mm



③ x 6

Wooden Pegs



⑥ x 2

Allen Key



④ x 1

ASSEMBLY INSTRUCTIONS

CABINET

STEP 6

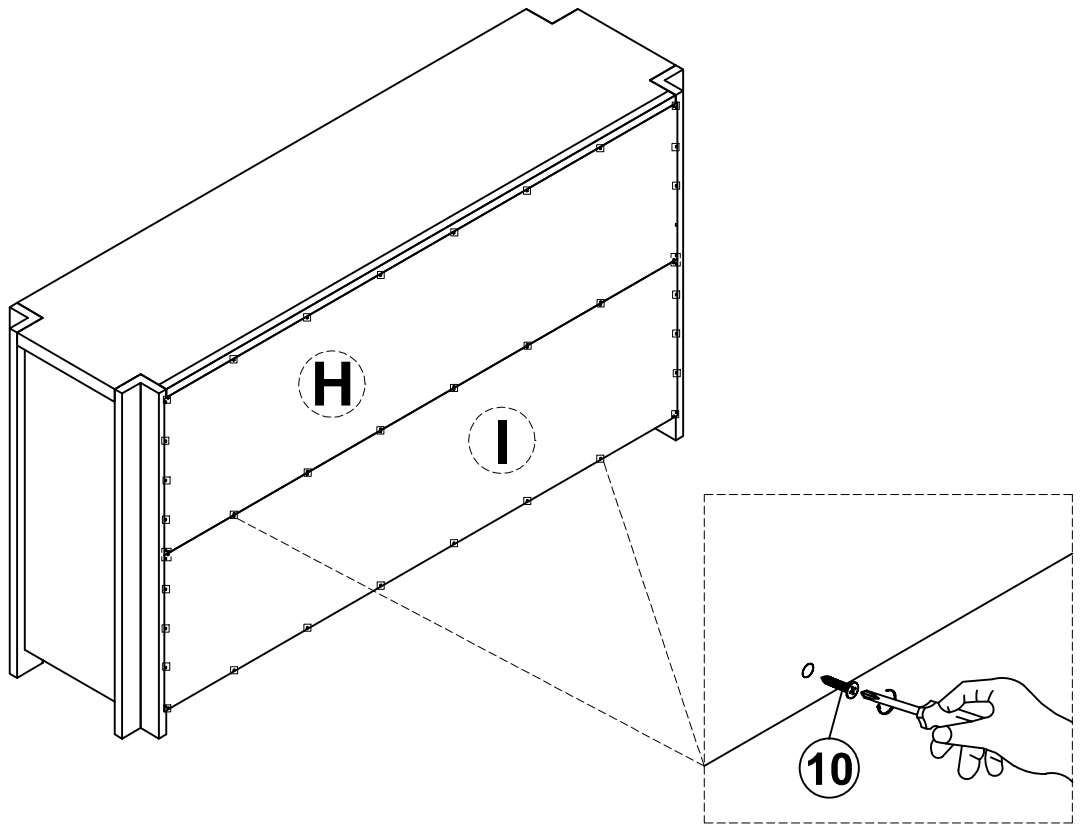

SCREW 4x15mm
(Umbrella head screw)



10 x 52

STEP 7

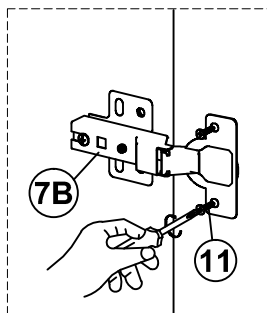
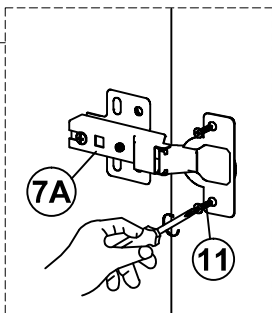
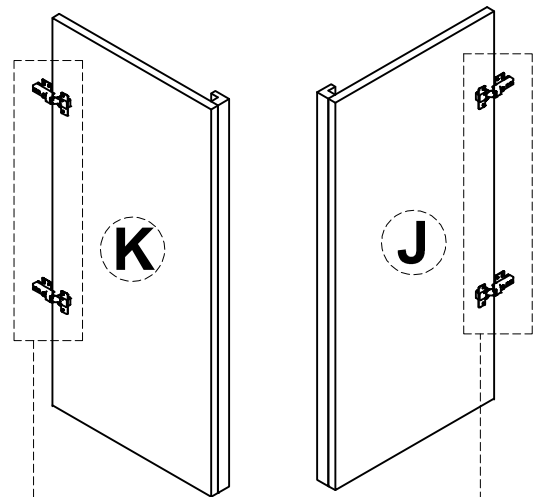
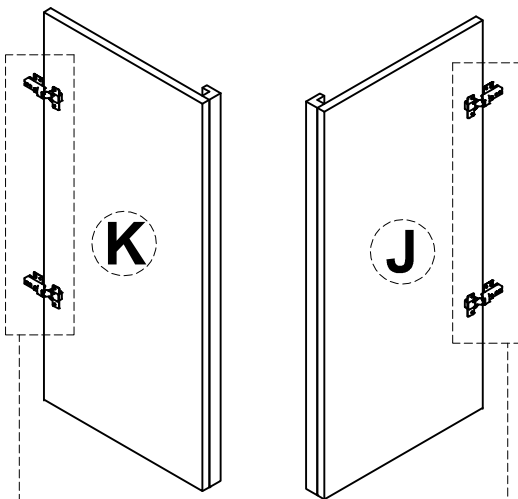

Damper hinge

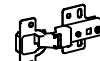

7A x4

Damper hinge

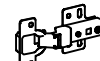

7B x4

SCREW 4x15mm
(Flat head screw)



11 x 16

ASSEMBLY INSTRUCTIONS

CABINET

STEP 8

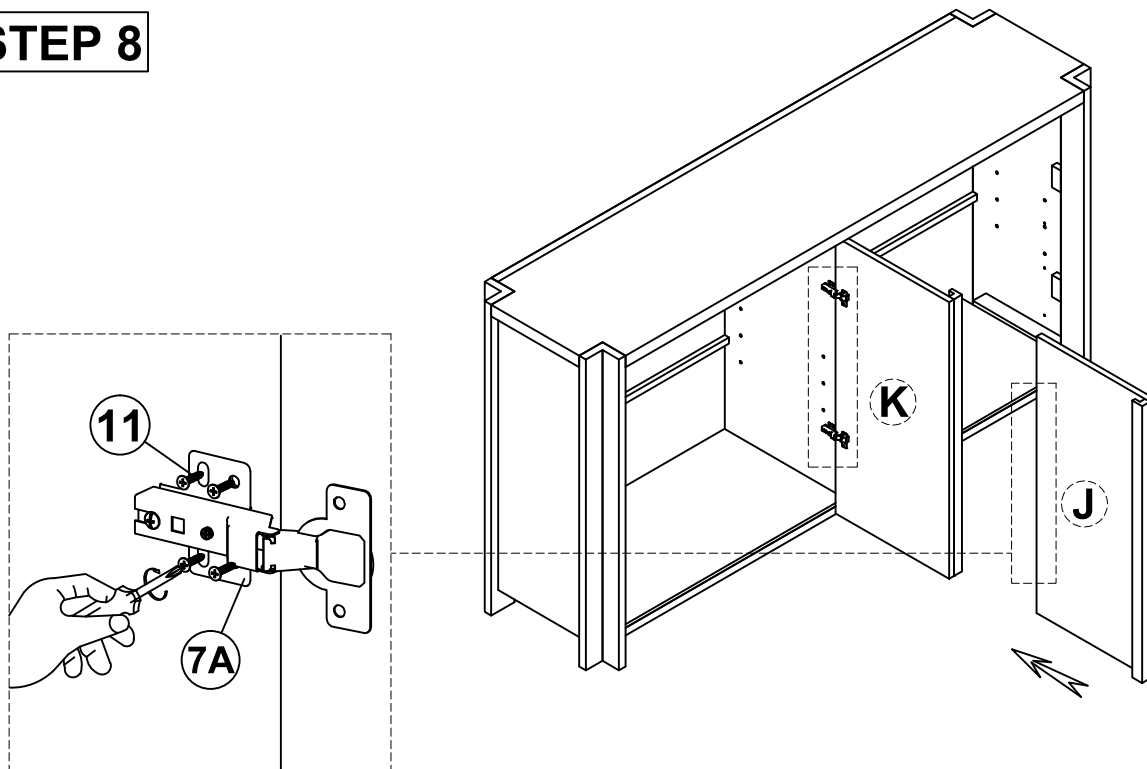

SCREW 4x15mm
(Flat head screw)



(11) x 16

STEP 9

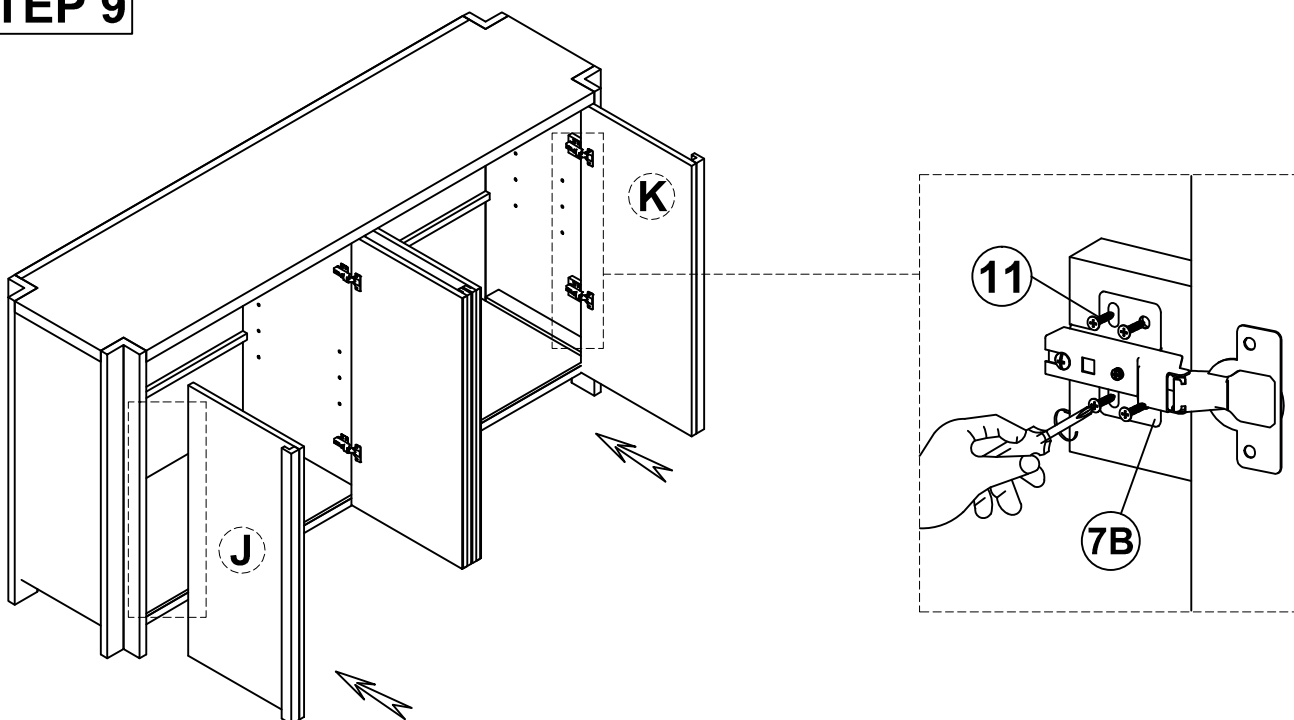

Please assemble the door according to the installation steps first. If the cabinet door is deviated, the internal hinge needs to be slowly adjusted to solve the problem.

SCREW 4x15mm
(Flat head screw)



(11) x 16

ASSEMBLY INSTRUCTIONS

CABINET

STEP 10

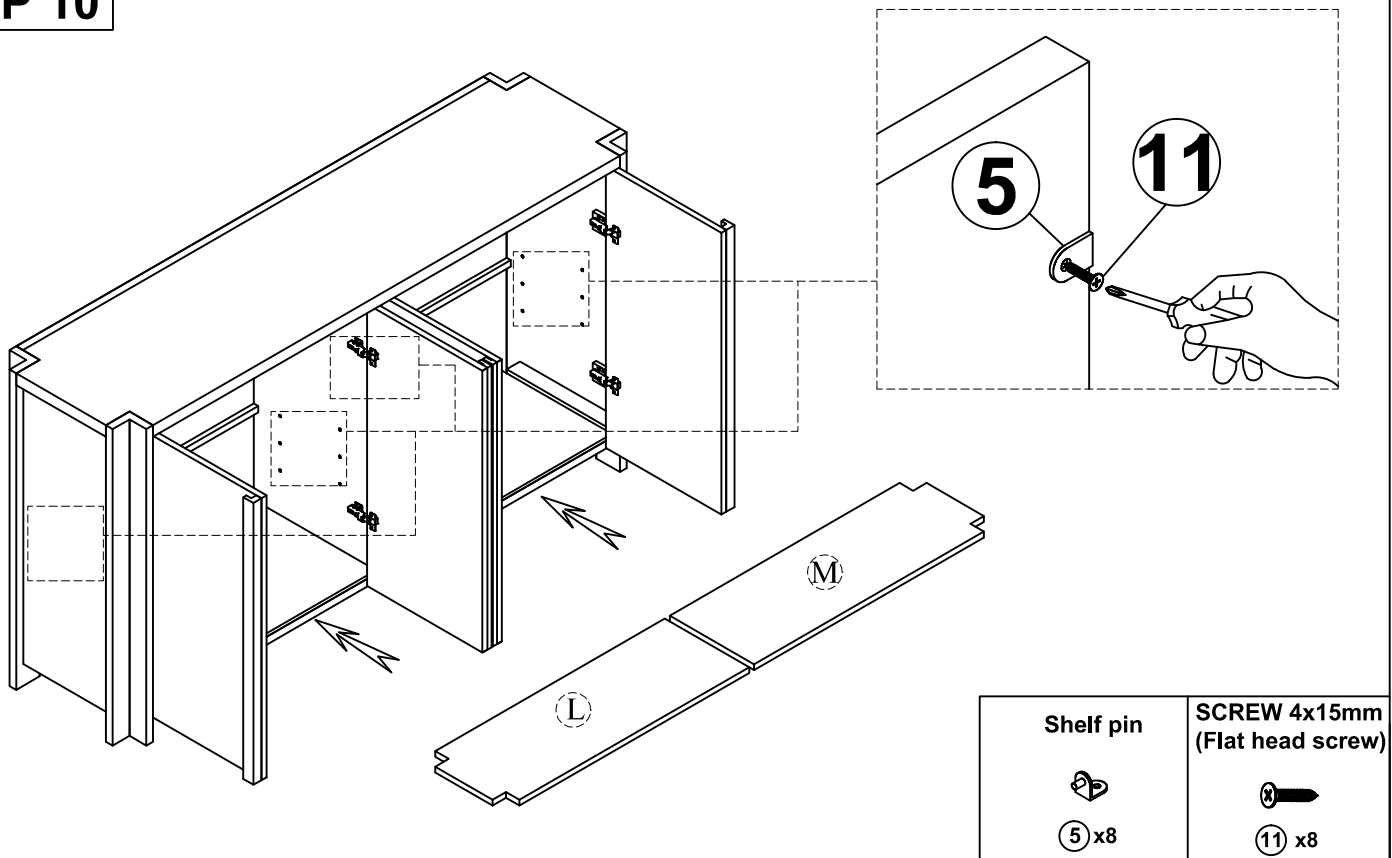

- Select the location to place the table
- Drill a hole in the dry wall to fit Anchor
- Then included the Patch L with Long screw
- Assembly the Patch L to the table and affix by short Screw.

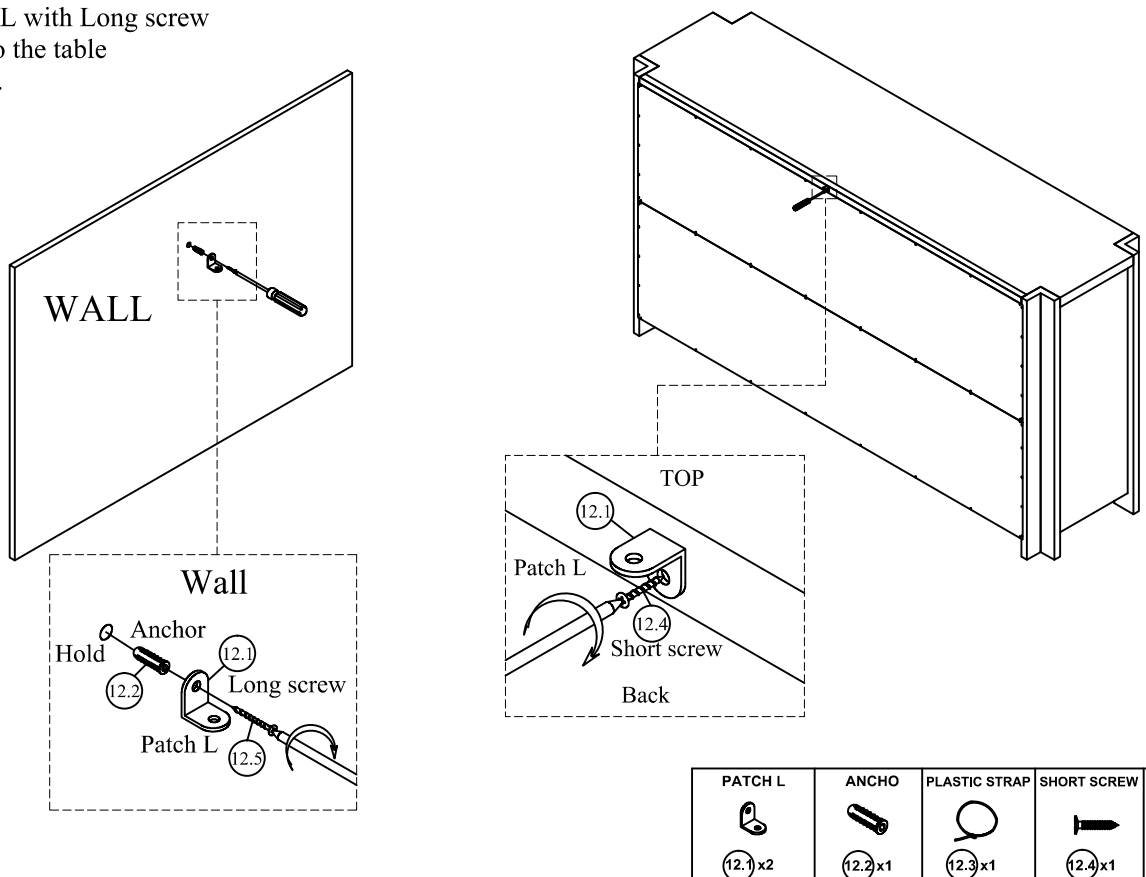

ASSEMBLY INSTRUCTIONS

CABINET

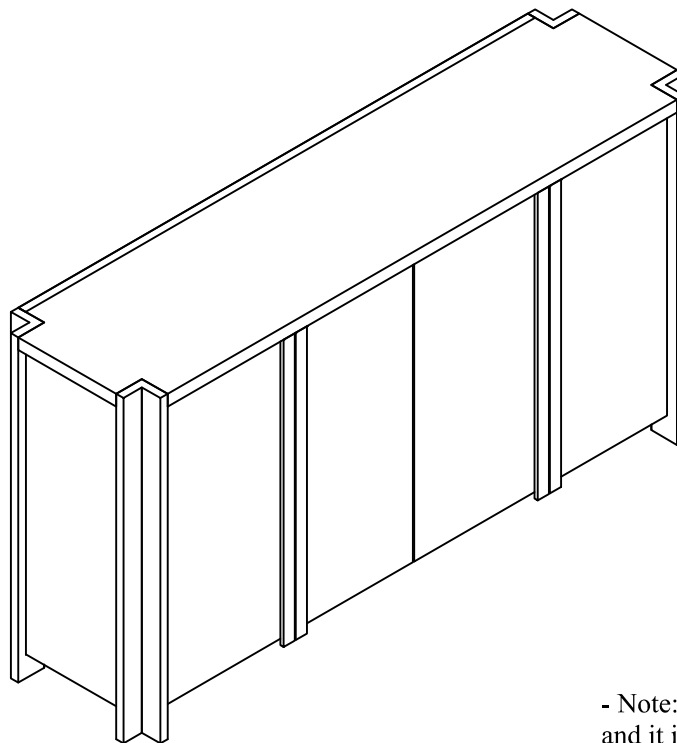
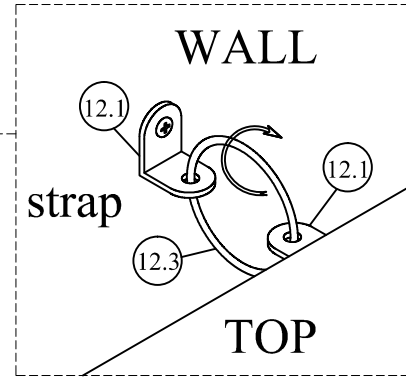
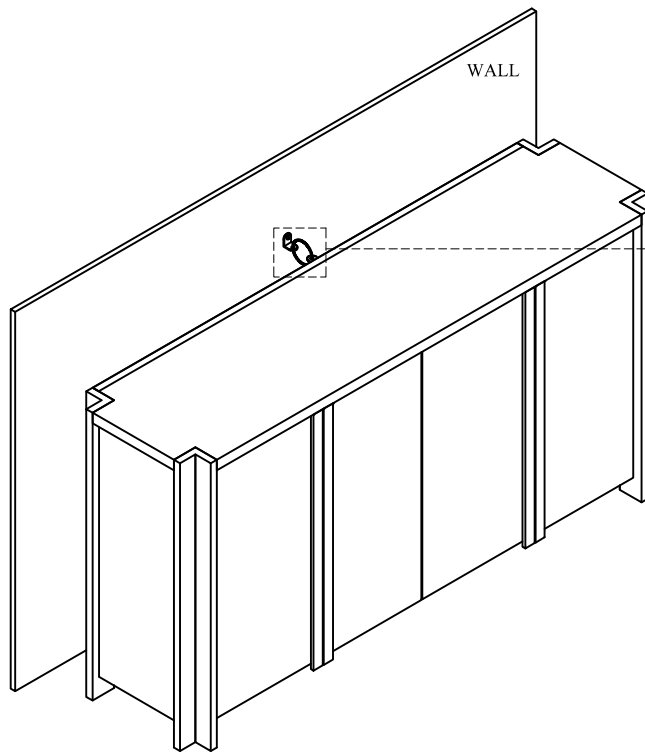

- Note: This is not a clothing storage cabinet and it is not recommended to use it as a clothing storage cabinet.
- All cabinets come with stainless steel or our "L-Bracket "when shipped.