

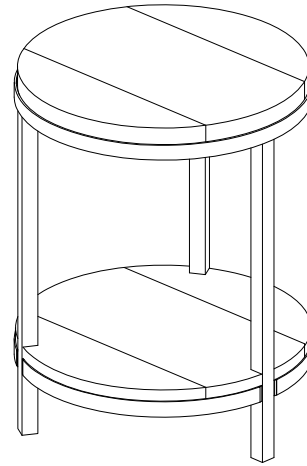





ASSEMBLY INSTRUCTIONS

990-918 TBL,END ROUND

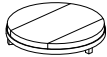

No.	Hardware List	Q'ty
1	 M5/16"	1pc
2	 Ø5/16 "x5/8 "	6pcs
3	 Ø5/16"	6pcs
4	 Ø5/16"*19mm	6pcs

No.	Part List	Q'ty
A		1pc
B		3pcs
C		1pc

1st Step:

Firstly ,lay top(A) face-down on a clear and smooth surface.

Then attach leg(B) to top(A) with flat washer(4), spring washer(3), allen head bolt(2). Use allen wrench(1) to tighten. As in shown.

2nd Step:

Connect face-up shelf (C) with top (A) with flat washer (4), spring washer(3), allen head bolt (2) by insert ing into legs(B),Use the allen wrench(1) to tighten all bolts. Tighten fully all bolts. As in shown.

