

PARTS

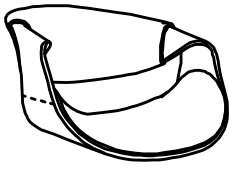

A

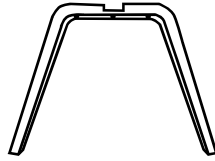

B

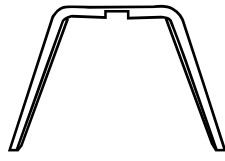

C



x1
6X30mm
F

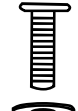

x4
6x45mm
G



L

1

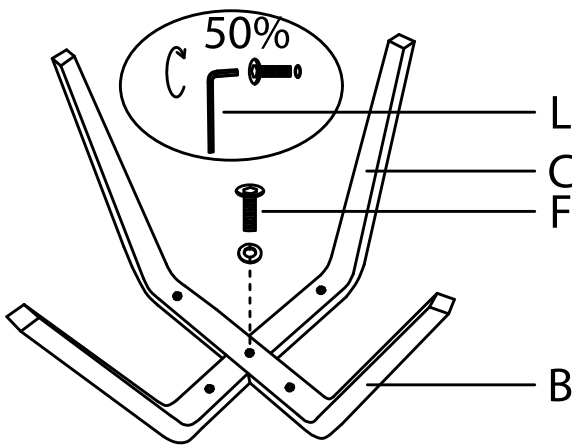

2

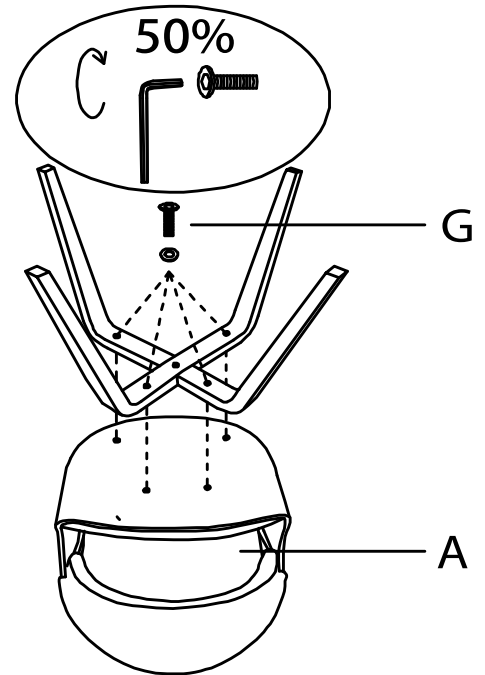

3

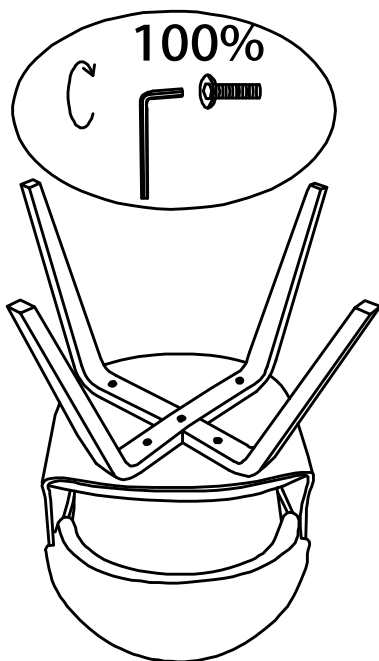

4

