

# Parts Description- Loveseat

## Important installation tips:





Since our products need to be assembled, each box contains individual parts, screw and instructions. In order to reduce the difficulty of assembly and confusion, please complete the assembly as follows:





1. please open one box first, take out the parts, manuals, screws
2. assembly
3. and open the second box and so on.

If you have any assembly questions, please contact us.



## Part list:Left & Right Corner Chair

Left Corner Arm 1 PCS	Right Corner Arm 1 PCS
 <p>A rectangular woven armrest with a dark frame and a light-colored woven top. A small red label with the letter 'B' is attached to the top surface.</p>	 <p>A rectangular woven armrest with a dark frame and a light-colored woven top. A small red label with the letter 'A' is attached to the top surface.</p>
<p>Instruction Part number: B            Feature1: The curve is on the left            Feature2: 4 holes on the front</p>	<p>Instruction Part number:A            Feature1: The curve is on the Right            Feature2: 4 holes on the front</p>
Left Corner Seat 1 PCS	Right Corner Seat 1 PCS
 <p>A square woven seat with a dark frame and a light-colored woven top. A small red label with the letter 'I' is attached to the top surface.</p>	 <p>A square woven seat with a dark frame and a light-colored woven top. A small red label with the letter 'F' is attached to the top surface.</p>
<p>Instruction Part number: I            Feature1: 2 holes on the left are on the side            Feature2:2 holes on the right are on the front            Feature3:L shape</p>	<p>Instruction Part number:F            Feature1: 2 holes on the left are on the Front            Feature2:2 holes on the right are on the side            Feature3:L shape</p>

<p align="center"><b>Left Corner Back 1 PCS</b></p>	<p align="center"><b>Right Corner Back 1 PCS</b></p>
 <p>A rectangular woven mat with a dark, textured top layer and a lighter, smoother bottom layer. A small red label with the letter 'H' is attached to the top layer.</p>	 <p>A rectangular woven mat with a dark, textured top layer and a lighter, smoother bottom layer. A small red label with the letter 'E' is attached to the top layer.</p>
<p align="center">Instruction Part number:H  Feature1: 2 holes on the left are on the front  Feature2:2 holes on the right are on the side  Feature3:l shape</p>	<p align="center">Instruction Part number:E  Feature1: 2 holes on the left are on the side  Feature2:2 holes on the right are on the front  Feature3:l shape</p>
<p align="center"><b>Left Corner Right Side Panel 1 PCS</b></p>	<p align="center"><b>Right Corner Right Side Panel 1 PCS</b></p>
 <p>A rectangular woven mat with a dark, textured border and a lighter, smoother center. A small red label with the letter 'J' is attached to the center.</p>	 <p>A rectangular woven mat with a dark, textured border and a lighter, smoother center. A small red label with the letter 'G' is attached to the center.</p>
<p align="center">Instruction Part number:J  Feature1: radians on the right</p>	<p align="center">Instruction Part number:G  Feature1: radians on the left</p>

**Part list & Left Corner Chair**



**B 1Pc**  
Left Corner Arm



**H 1Pc**  
Left Corner Back



**I 1Pc**  
Left Corner Seat

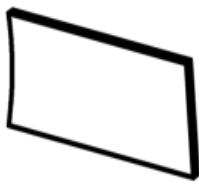

**J 1Pc**  
Left Corner Right Side Panel

**Hardware & Left Corner Chair**



**GG 8Pcs**  
Nut & Washer



**M6\*35**  
**BB 1Pc**  
Screw M6\*35



**M6\*50**  
**AA 8Pcs**  
Screw M6\*50



**M6\*30**  
**DD 4Pcs**  
Screw M6\*30



**HH 1Pc**



**II 1Pc**

Screw Tool



**FF 4Pcs**  
Adjustable Feet

**Cushion & Left Corner Chair**

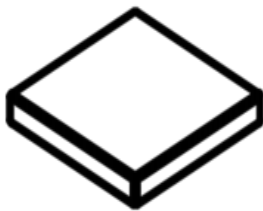





**A1 1Pc** Seat Cushion





**B1 1Pc** Back Cushion

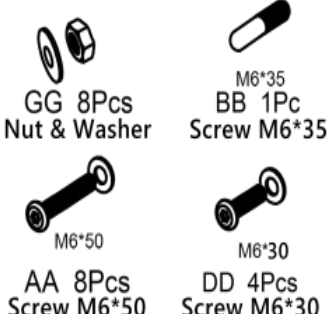

**Part list & Right Corner Chair**

 <p>B 1Pc Right Corner Arm</p>	 <p>H 1Pc Right Corner Back</p>	 <p>I 1Pc Right Corner Seat</p>
 <p>J 1Pc Right Corner Right Side Panel</p>		

**Hardware & Right Corner Chair**

 <p>GG 8Pcs Nut &amp; Washer</p> <p>AA 8Pcs Screw M6*50</p> <p>BB 1Pc Screw M6*35</p> <p>DD 4Pcs Screw M6*30</p>	 <p>HH 1Pc    II 1Pc</p> <p>Screw Tool</p>	 <p>FF 4Pcs Adjustable Feet</p>
---------------------------------------------------------------------------------------------------------------------------------------------------------------------------------------------------------------------	-------------------------------------------------------------------------------------------------------------------------------	--------------------------------------------------------------------------------------------------------------------------

**Cushion & Right Corner Chair**

 <p>A1 1Pc    Seat Cushion</p>	 <p>B1 1Pc    Back Cushion</p>	
-------------------------------------------------------------------------------------------------------------------	-------------------------------------------------------------------------------------------------------------------	--

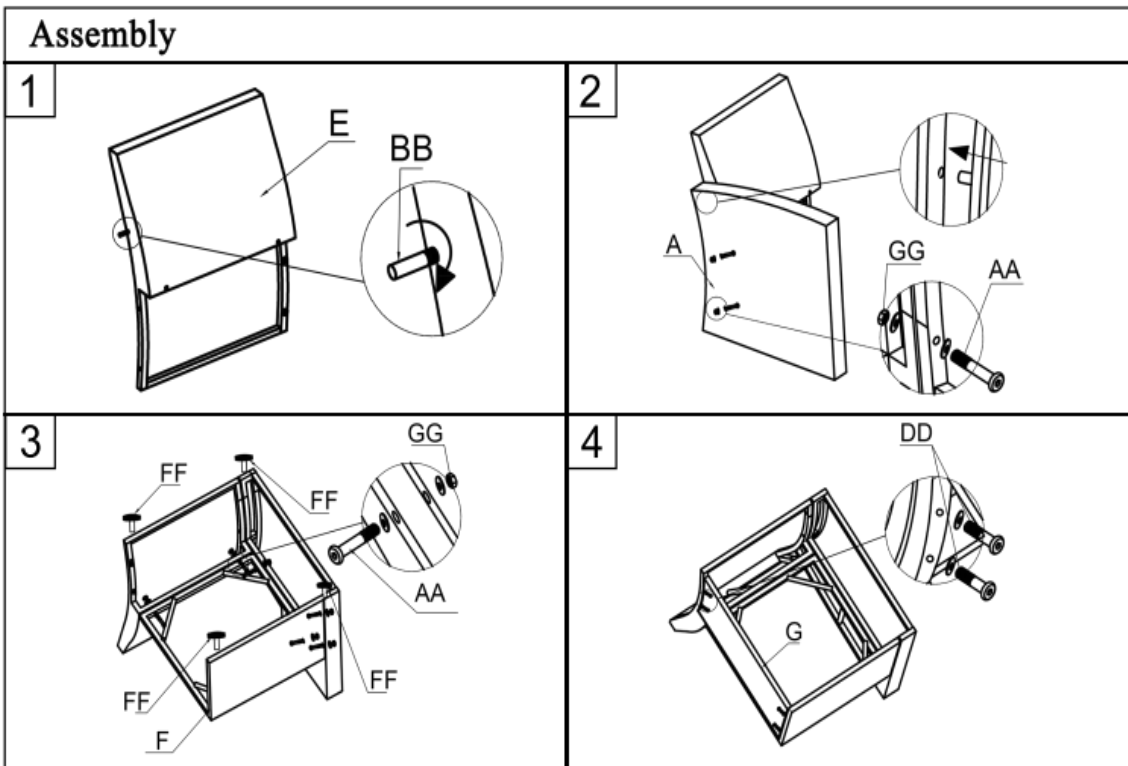
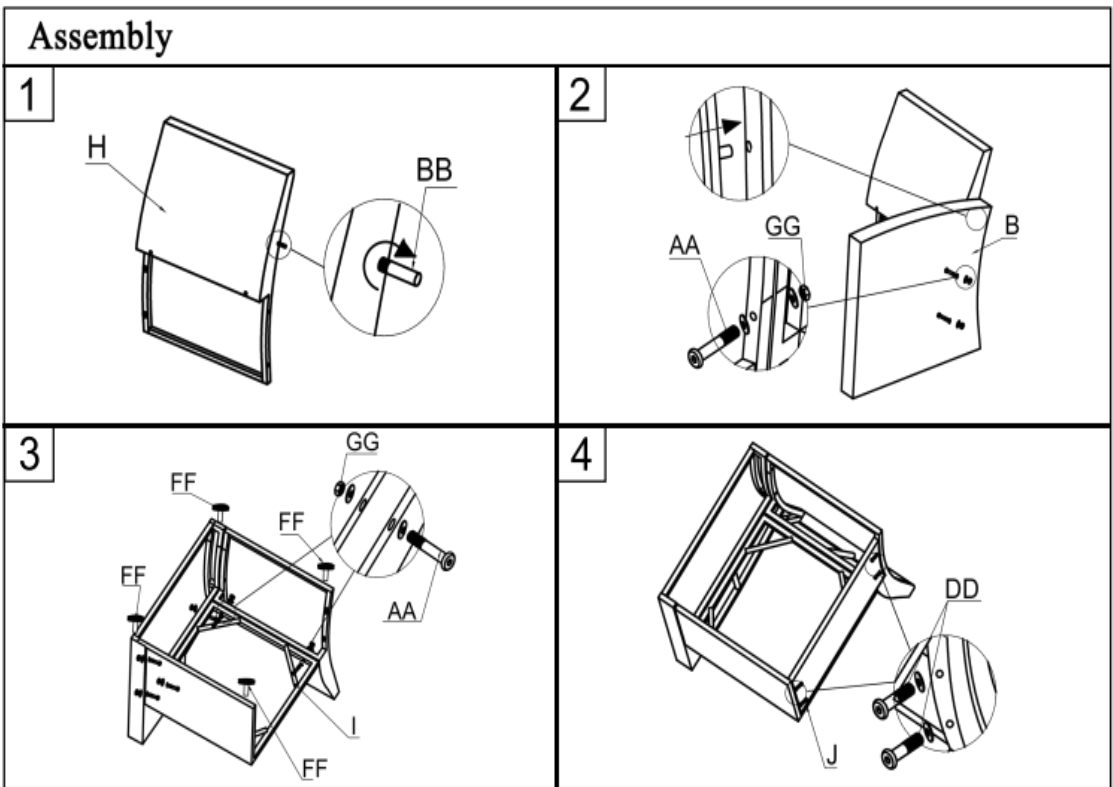

# Outdoor Sectional Sofa Clips

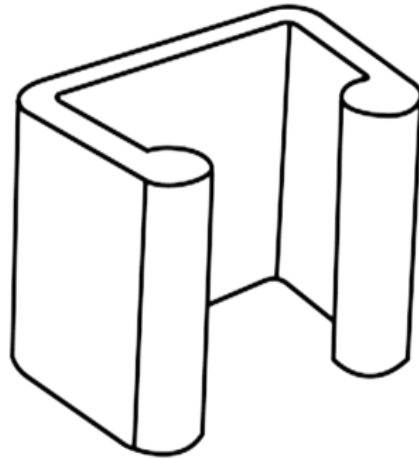

2PCS

1. Firstly hook it one side.
2. Press the outdoor patio sofa furniture clips hard.
3. Please note that in order to connect the sofa better, the outdoor furniture clips are designed a bit tight, just use it as the picture shows, and it will install easily.
4. Outdoor aluminum sectional sofa is very light weight and subject to movement, especially your kids or pets will always bump the outside furniture apart, which is dangerous when playing. And our patio furniture clips will effectively prevent movement between sectional or module furniture, no need to fix your outdoor patio furniture everyday.

## Clips Assembly

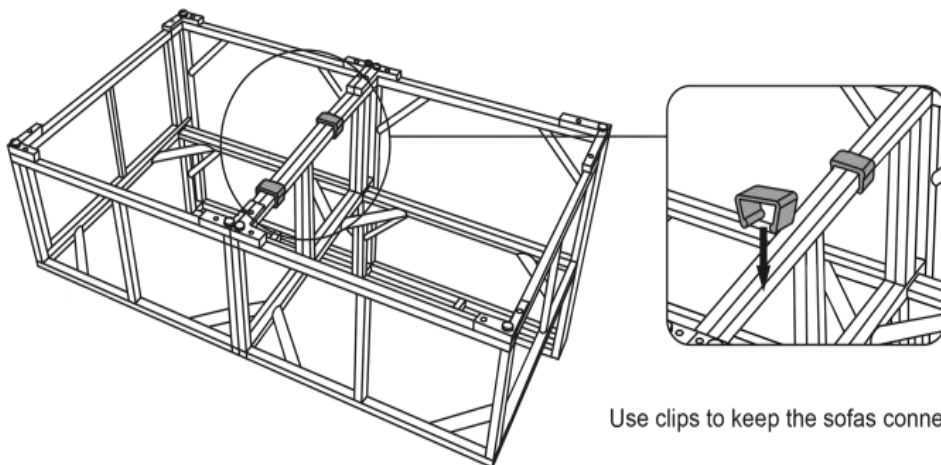

Use clips to keep the sofas connected.

# Make Your Outdoor Furniture Last Longer!

## 1. Protect Your Furniture From The Sun & Rain

Outdoor furniture is made to weather the elements, but eventually all that exposure will take its toll. When not in use, your furniture doesn't need to be exposed to the elements. Storing items under a protective shelter will limit their contact with the sun and rain, thereby doubling or even tripling their lifespans. Any kind of shelter that is safe from the elements of nature is a safe bet. Consider using a storage shed, the garage.

## 2. Keep your stuff clean

If you stay on top of things by giving your patio table and chairs a quick five-minute wash once a week or so, you'll avoid the headaches that arise later due to built-up dirt, grime, and pollen. No need for a full-on pressure wash; keep it easy by picking off stray leaves and twigs, then giving your furniture a quick spray with the garden hose. Voila!

## 3. Store cushions when you aren't using them

Even the sturdiest fabric is susceptible to mildew, sun bleaching, and build-up from dirt and pollen. That's why storing outdoor cushions somewhere cool and dry when you're not using them is best practice. Storing your cushions and pillows will significantly extend their lifespan. Invest in a few outdoor storage boxes if you have space, or opt for an easy-to-reach indoor storage solution in your entryway or garage.

## 4. Cover or store your furniture during the off-season

When the end of summer rolls around (since all good things must pass), proper storage of your outdoor furniture is crucial.

Snow and extremely cold temperatures will significantly reduce the lifespan of your furniture, while proper storage will ensure its long, happy existence.

An outdoor shed or garage will do just fine (a storage facility works too if you don't have either of those). Just be sure to properly wash and dry your items before storing so they'll be ready to use and in tip-top condition once sunny days return again.

5. You can find more chairs that match your purchased sofa on our website:

6. You can find suitable accessories like a protect cover for your sofa on our website:

## We'd love to hear from you!

Thank you for your recent purchase of our product. We hope you will be pleased with both the product and service you received.

If you received the product with missing accessories\damaged parts\ installation problem, please do not worry. please provide (1) copy of your order, (2) pictures of your damaged parts, (3) your problem, contact us via email. Our team members are more than happy to help.

Meanwhile, we also welcome you to post a Product Review so that others can benefit from your experience. As a growing business, we know how scarce time can be, so we especially appreciate your time and input.