

# Assembly Instruction

**CAUTION:** Read instruction carefully and turn electricity off at main circuit breaker panel before beginning installation.

Size:W20.7"\*H12.6"\*E5.31"

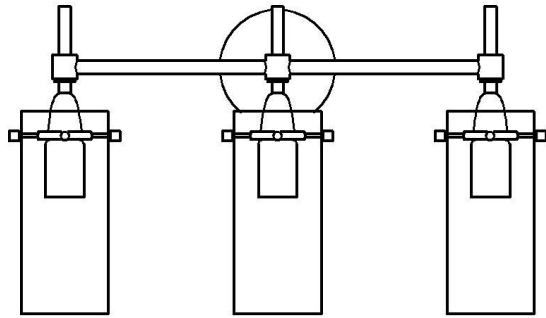

## Care and Cleaning







To clean the outside of the fixture, use a dry or slightly dampened clean cloth (use clean water, never a solvent) to wipe the surface of the fixture.

To clear the inside of the fixture, first disconnect power to the fixture by turning off the circuit breaker or by removing the fuse at the fuse box. Next, use a dry or slightly dampened clean cloth (use clean water, never a solvent) to wipe the interior surface of the fixture.

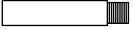
Do not use any cleaners with chemical, solvents or harsh abrasives. Use Only a dry soft cloth to dust or wipe carefully.

Estimated Assembly Time:30 minutes

## Part List and Hardware List

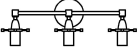
PIECE	DESCRIPTION	PICTURE	QUANTITY	PIECE	DESCRIPTION	PICTURE	QUANTITY
<b>A</b>	Mounting bar		<b>1X</b>	<b>C</b>	Pipes		<b>3X</b>
<b>A1</b>	Mounting screw		<b>2X</b>	<b>D</b>	Bulb		<b>3X</b>
<b>A2</b>	Machine screw		<b>2X</b>	<b>E</b>	Round nut		<b>3X</b>
<b>B1</b>	Wire nut		<b>3X</b>	<b>F</b>	Glass		<b>9X</b>
<b>B</b>	Fixture body		<b>1X</b>				

# Installation

## Step 1

1. installing the mounting bar(A) with mounting screw(A1)
2. installing the pipes(C) to the fixture body(B)

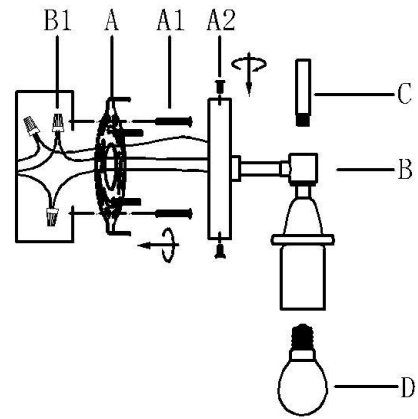

## Step 2 Wire connection

Connect, Hot, Black or Red outlet Supply Wire to:	Connect, Neutral, White Outlet Supply Wire to:
Black	White
*Parallel Cord(round&smooth)	*Parallel Cord(square&ridged)
Clear, Brown, Gold or Black without Tracer(colored stripes)	Clear, Brwn, Gold or Black without Tracer(colored stripes)
Insulated Wire(not green)with copper metal conductor	Insulated Wire(not green)with Silver metal conductor

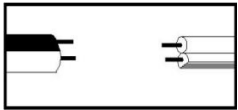

\*Note: When parallel wire(SPTI&SPTII)is used. The neutral wire is square shaped and ridged and the hot wire will be round in shape and smooth.(See illustration on left)

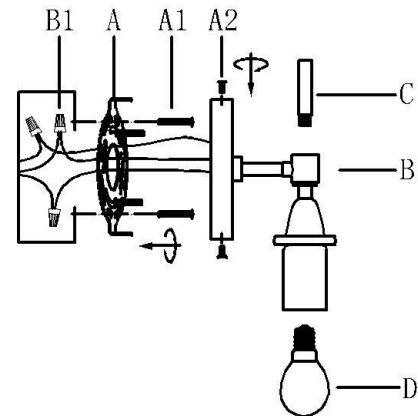
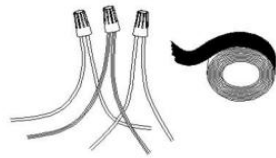

## Step 3

1. Secure the fixture body(B) with machine screw(A2).
2. Place the bulb(D) to the socket.
3. Install the glass(F) to the fixture body(B) with round nut(E).

PLEASE USE ON/OFF TYPE "B" BULB MAX 40-WATT  
 OR CFL BULB MAX 13-WATT  
 OR LED BULB MAX 9-WATT  
 THERE ARE 3PCS 4W LED BULB IN THE BOX.

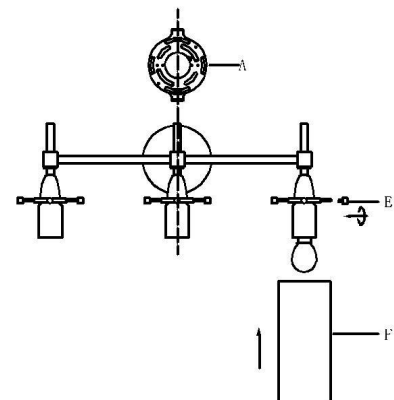

## Step 4

Consult a qualified electrician to ensure correct branch circuit conductor