

Parts

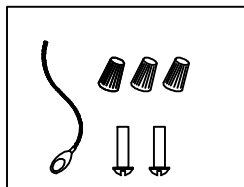

Steps ①

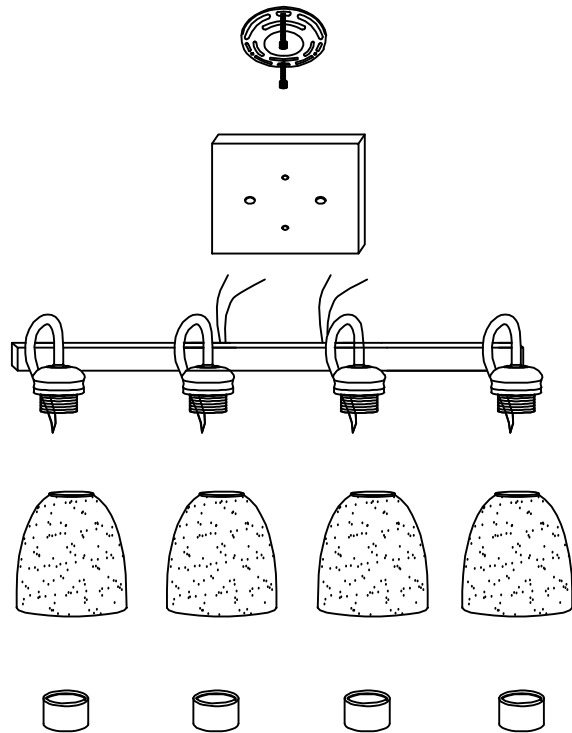
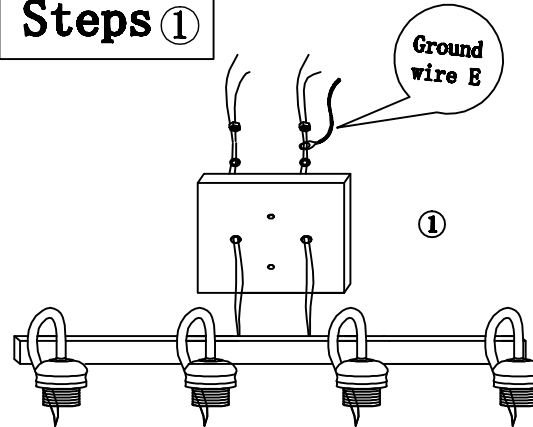

1. Loosen the nut on the lamp body, thread the wire through the canopy, and assemble the light fixture and canopy with the nut. (Use one of the nuts to lock the ground wire E)

Steps ②

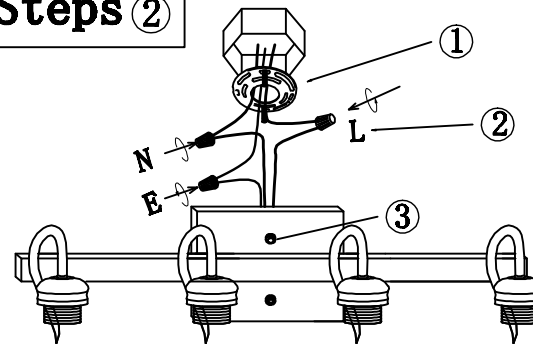

1. Assembled the mounting bracket to the ceiling junction box with the screw.
 2. Connect the power cord out from the ceiling junction box to lamp wires with the lead wire and wire nut, according the color to connect. (U.S. - black for "L", white for "N", copper wire for "Ground E")
 3. Assemble the canopy to the mounting bracket with the screw.

Steps ③

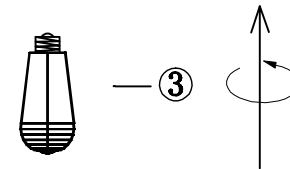
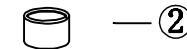
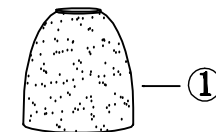
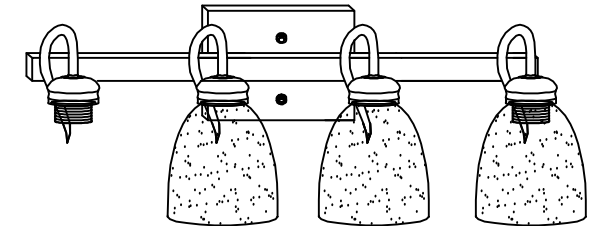

1. Install the lamp cover.
2. Screw the lamp ring.
3. Install the light bulb. (bulb not included)