

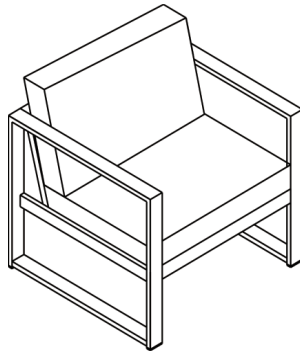

# Assembly Instructions

**Caution : You must read this before you proceed**





## Chair

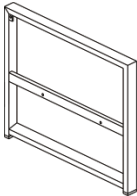
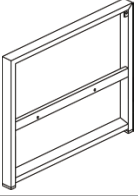
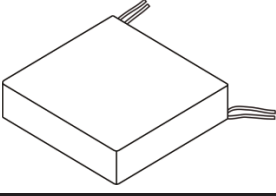
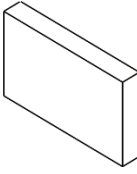





### Parts List



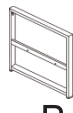
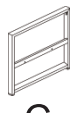
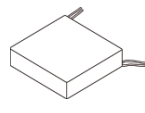
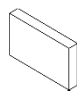

Label	Picture	Description	QTY
A		Seat	1
B		Right Armrest(Pre-InstalledLevellers)	1
C		Left Armrest(Pre-InstalledLevellers)	1
D		Seat Cushion	1
E		Back Cushion	1

# Hardware

Label	Picture	Description	QTY
①		Bolt (M6*40MM)	5
②		Bolt (M6*32MM)	3
③		Washer	7
④		Allen Wrench	1

# Assembly Preparation

Before Beginning Assembly :					
					

-  • Read instructions, cover to cover-
-  • Have 2 adults on hand for assembly-
-  • Do not assemble on flooring or carpet-
-  • Assemble on a clean non-marring surface (packing foam)-
-  • Save all packaging until finished-

# Assembly Steps

## Overview

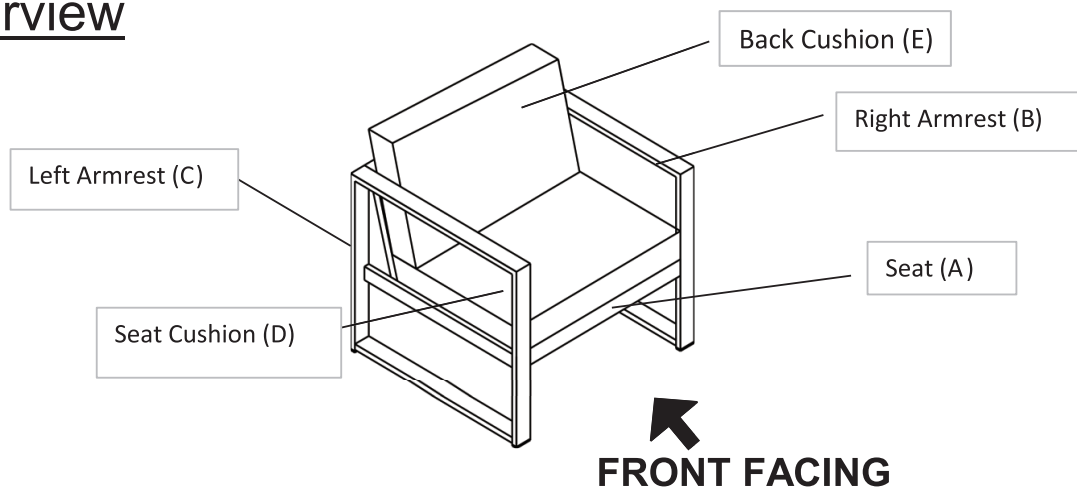

This Chair has multiple parts and may require up to 30 minutes to assemble. To give you an overview of the Chair parts, the above picture is to help you put the various parts into perspective. Please read through the instructions below to familiarise yourself with the parts and steps before assembly.

## Step 1

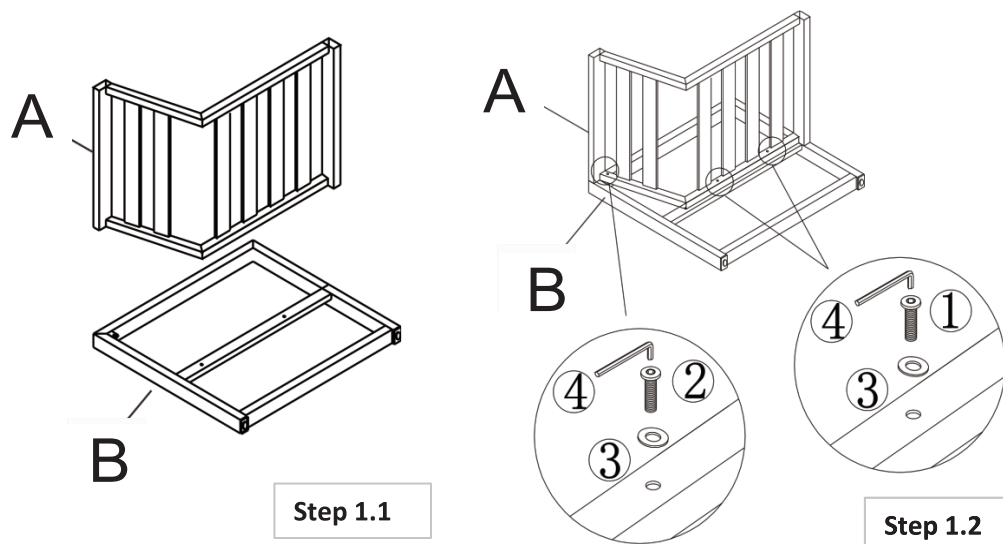

Open the carton and place all the parts onto a clean, non-marring surface.  
Place the Right Armrest(B) facedown.

**1.1)** Align Seat(A) to Right Armrest(B) as shown above.

**1.2)** Attach Seat(A) to Right Armrest(B) using Bolts(①), and Washers(③) with Allen Wrench(④) as shown above.

Attach Seat(A) to Right Armrest(B) using Bolt(②), and Washer(③) with Allen Wrench(④) as shown above.

**Tighten the Bolts fully in a sequential manner.**

## Step 2

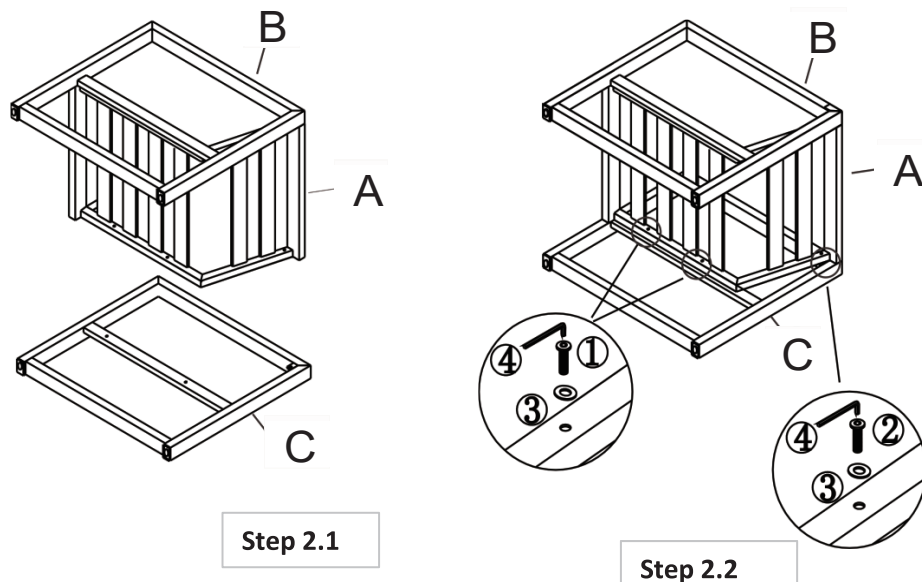

**2.1)** Align Seat(A) to Left Armrest(C) as shown above.

**2.2)** Attach Seat(A) to Left Armrest(C) using Bolts(①), and Washers(③) with Allen Wrench (④) as shown above.

Attach Seat(A) to Left Armrest(C) using Bolt(②), and Washer(③) with Allen Wrench(④) as shown above.

**Tighten the Bolts fully in a sequential manner.**

### Step 3

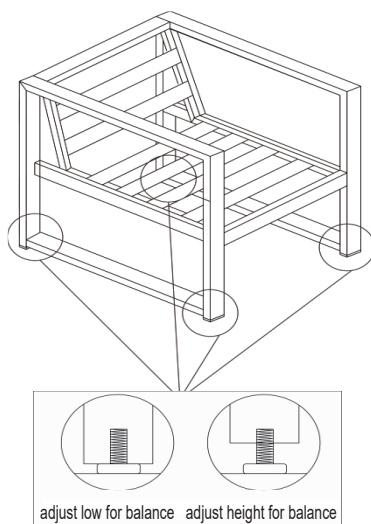

Then, with the assistance from an adult partner, stand the Chair upright. Adjust the Pre-installed Levellers until the Chair is level with the ground. To adjust the Levellers, with assistance from an adult partner, tilt the Chair to rest on two feet. Adjust the levellers to the desired height until the Chair is level.

### Step 4

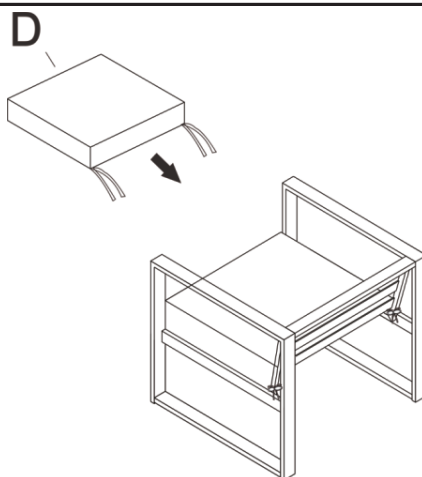





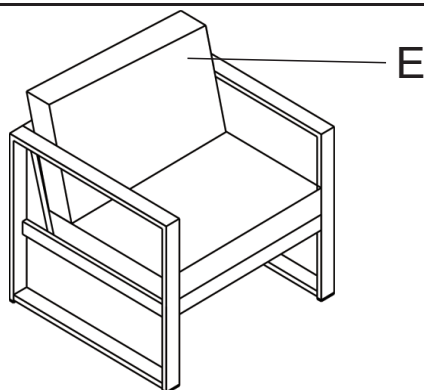















Place the Seat Cushion(D) on the Seat(A). Tie the rope to the Seat(A).

### Step 5



Place the Back Cushion(E) on the Chair. Your Chair is ready for use.  
**This Chair can only be used on a flat and level surface.**

## Care & Maintenance

-   ● Do not put hot items directly on furniture surface
  -   ● Do not clean furniture with harsh cleansers or polish.
  -   ● To obtain the longest lifespan of your outdoor products, minimizing exposure to direct sunlight is recommended.
  -   ● Children should not climb or jump on the furniture.
  -   ● Do not write on furniture without a padded barrier to protect the surface.
  -   ● To obtain the longest lifespan of your outdoor products, avoid extended and lengthy exposure to rain, snow, and direct sunshine. Whenever possible cover the product and /or place under patio or awnings.
  -   ● Not for commercial use. For residential use only .
  -   ● Stains may be removed with mild soap solution and damp cloth.
  -   ● Keep away from sources of ignition.
- 
-   ● Dust and pick-up spills using a clean, non-colored, lint-free cloth.

# Assembly Instructions

**Caution : You must read this before you proceed**

## Loveseat

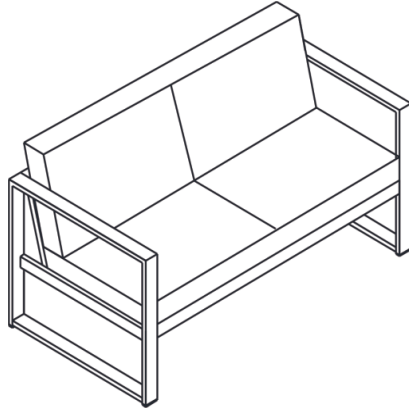

### Parts List

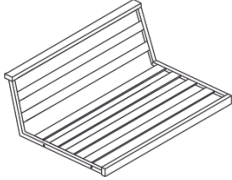
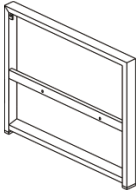
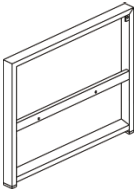
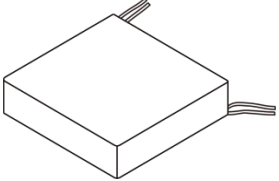
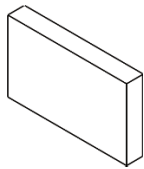
Label	Picture	Description	QTY
F		Seat	1
B		Right Armrest(Pre-InstalledLevellers)	1
C		Left Armrest(Pre-InstalledLevellers)	1
D		Seat Cushion	2
E		Back Cushion	2

# Hardware

Label	Picture	Description	QTY
①		Bolt (M6*40MM)	5
②		Bolt (M6*32MM)	3
③		Washer	7
④		Allen Wrench	1

# Assembly Preparation

Before Beginning Assembly :					

- Read instructions, cover to cover-
- Have 2 adults on hand for assembly-
- Do not assemble on flooring or carpet-
- Assemble on a clean non-marring surface (packing foam)-
- Save all packaging until finished-

# Assembly Steps

## Overview

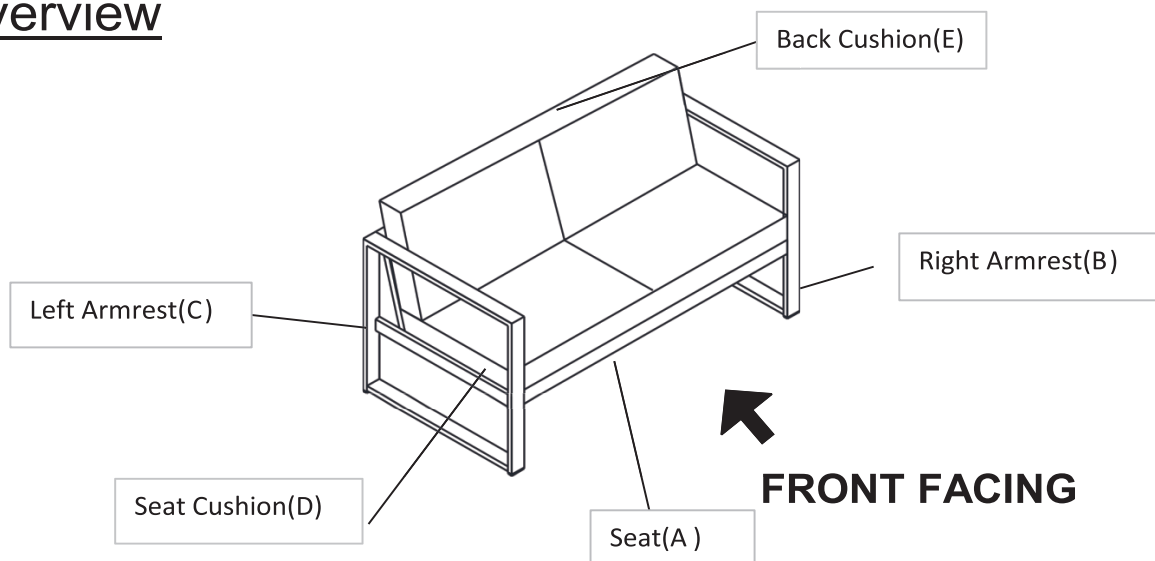

This Loveseat has multiple parts and may require up to 30 minutes to assemble. To give you an overview of the Loveseat parts, the above picture is to help you put the various parts into perspective. Please read through the instructions below to familiarise yourself with the parts and steps before assembly.

## Step 1

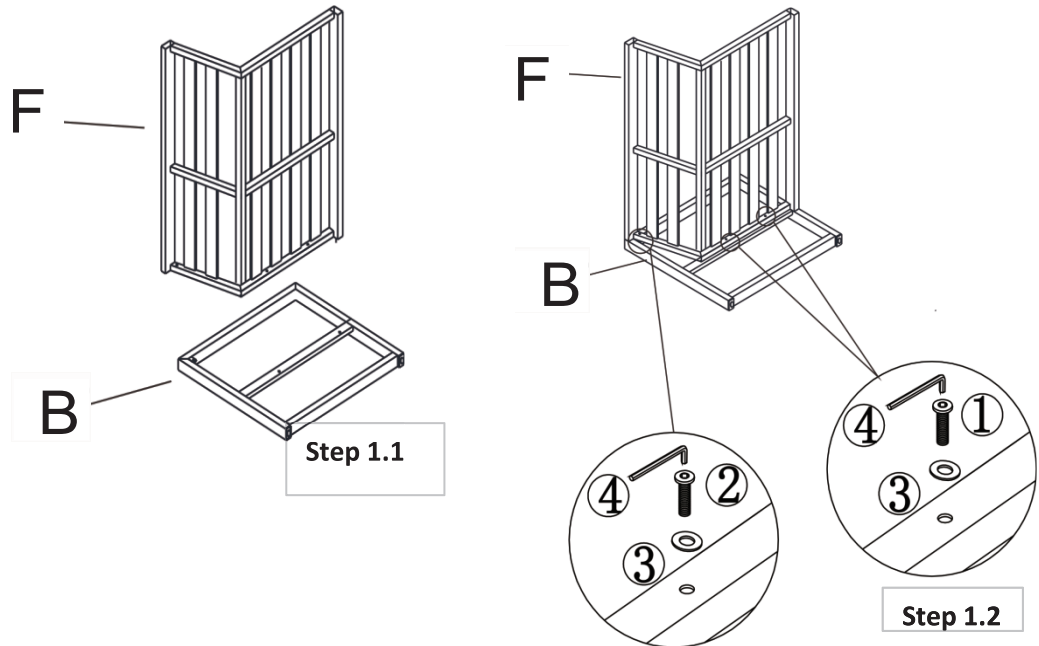

Open the carton and place all the parts onto a clean, non-marring surface.  
Place the Right Armrest(B) facedown.

**1.1)** Align Seat( F) to Right Armrest(B) as shown above.

**1.2)** Attach Seat( F) to Right Armrest(B) using Bolts(①), and Washers(③) with Allen Wrench(④) as shown above.

Attach Seat(F) to Right Armrest(B) using Bolt(②), and Washer(③) with Allen Wrench(④) as shown above.

**Tighten the Bolts fully in a sequential manner.**

## Step 2

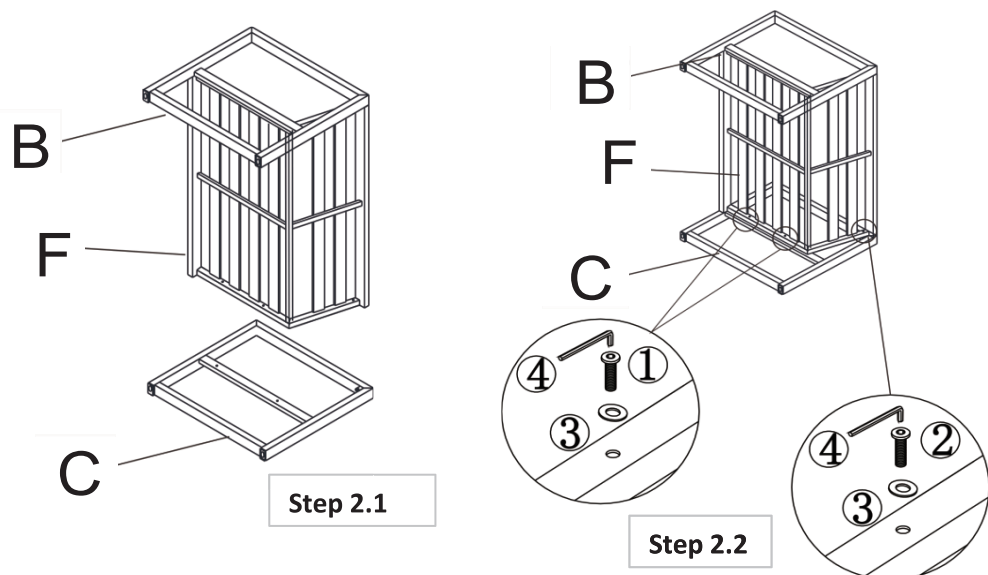

**2.1)** Align Seat(F) to Left Armrest(C) as shown above.

**2.2)** Attach Seat(F) to Left Armrest(C) using Bolts(①), and Washers(③) with Allen Wrench(④) as shown above.

Attach Seat(F) to Left Armrest(C) using Bolt(②), and Washer(③) with Allen Wrench(④) as shown above.

**Tighten the Bolts fully in a sequential manner.**

### Step 3

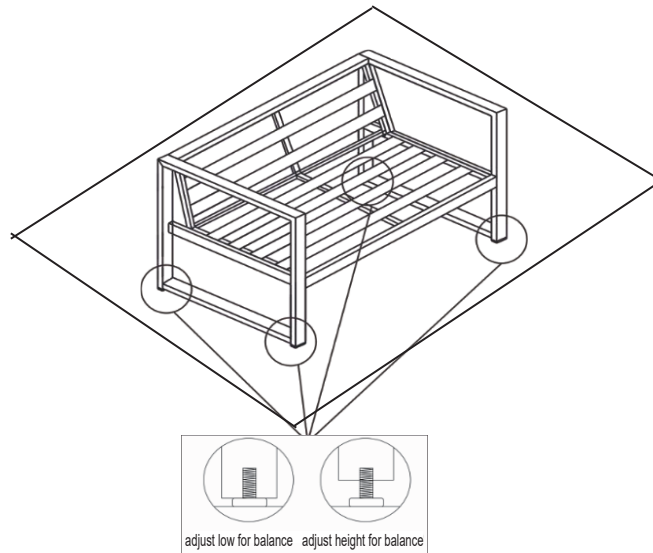

Then, with the assistance from an adult partner, stand the Loveseat upright.  
Adjust the Pre-installed Levellers until the Loveseat is level with the ground.  
To adjust the Levellers, with assistance from an adult partner, tilt the Loveseat to rest on two feet.  
Adjust the levellers to the desired height until the Loveseat is level.

### Step 4

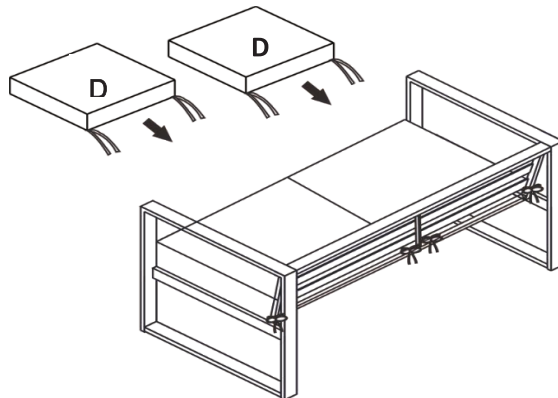





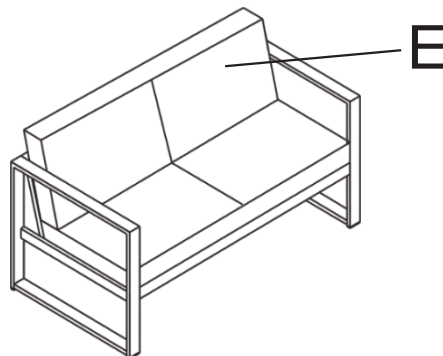















Place the Seat Cushions(D) on the Seat(F).  
Tie the rope to the Seat(F).

### Step 5



Place the Back Cushions(E) on the Loveseat.  
Your Loveseat is ready for use.  
**This Loveseat can only be used on a flat and level surface.**

## Care & Maintenance

-   ● Do not put hot items directly on furniture surface
  -   ● Do not clean furniture with harsh cleansers or polish.
  -   ● To obtain the longest lifespan of your outdoor products, minimizing exposure to direct sunlight is recommended.
  -   ● Children should not climb or jump on the furniture.
  -   ● Do not write on furniture without a padded barrier to protect the surface.
  -   ● To obtain the longest lifespan of your outdoor products, avoid extended and lengthy exposure to rain, snow, and direct sunshine. Whenever possible cover the product and /or place under patio or awnings.
  -   ● Not for commercial use. For residential use only .
  -   ● Stains may be removed with mild soap solution and damp cloth.
  -   ● Keep away from sources of ignition.
- 
-   ● Dust and pick-up spills using a clean, non-colored, lint-free cloth.