

CEILING FAN INSTALLATION MANUAL

SAFTY RULES

1. To reduce the risk of electric shock, insure electricity has been turned off at the circuit breaker or fuse box before beginning.
2. All wiring must be in accordance with the National Electrical Code and local electrical codes. Electrical installation should be performed by a qualified licensed electrician.
3. **WARNING:** To reduce the risk of electrical shock and fire, do not use this fan with any solid-state fan speed control device.
4. **WARNING:** To reduce the risk of fire, electric shock, or personal injury, mount to outlet box marked "Acceptable for Fan Support of 45kg (99.12 lbs.) Or Less" and use mounting screws provided with the outlet box. Most outlet boxes commonly used for the support of light fixtures are not acceptable for fan support and may need to be replaced. Due to the complexity of the installation of this fan, a qualified licensed electrician is strongly recommended.
5. The outlet box and support structure must be securely mounted and capable of reliably supporting a minimum of 45KGS. Use only UL Listed outlet boxes marked FOR FAN SUPPORT.
6. The fan must be mounted with a minimum of 7 feet clearance from the trailing edge of the blades to the floor.
7. Avoid placing objects in the path of the blades.
8. To avoid personal injury or damage to the fan and other items, be cautious when working around or cleaning the fan.
9. Do not use water or detergents when cleaning the fan or fan blades. A dry dust cloth or lightly dampened cloth will be suitable for most cleaning.
10. After making electrical connections, spliced conductors should be turned upward and pushed carefully up into the outlet box. The wires should be spread apart with the grounded conductor and the equipment-grounding conductor on one side of the outlet box.
11. Electrical diagrams are for reference only.
12. The fan is suitable for indoor use only.

TOOLS REQUIRED





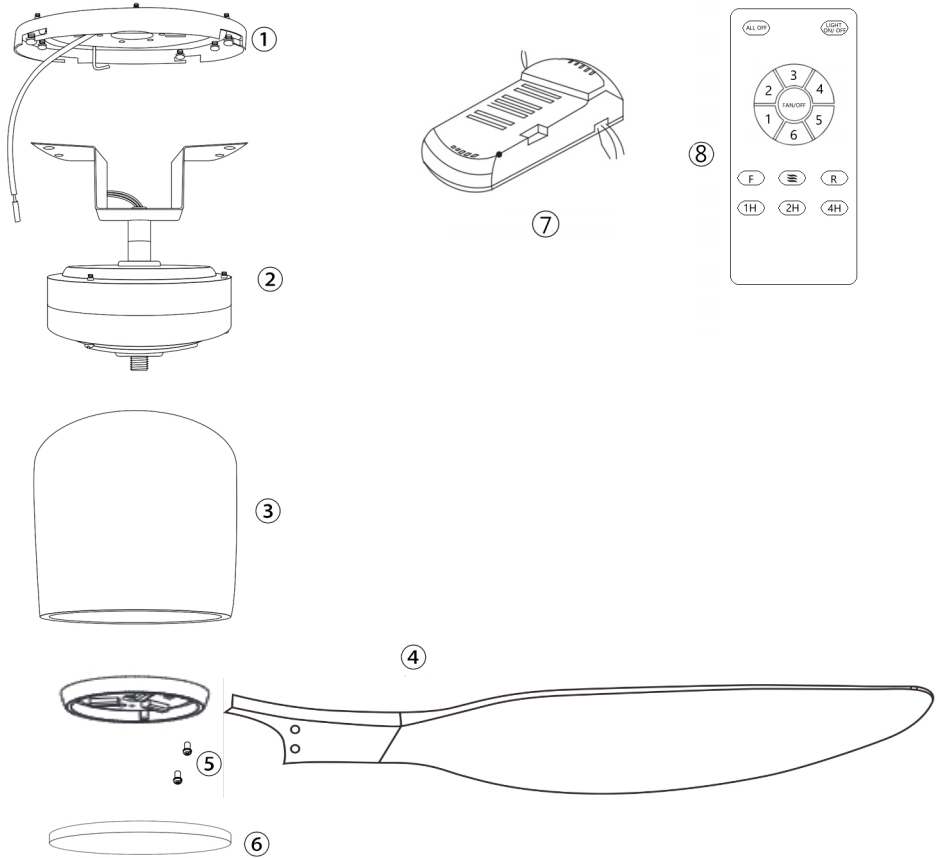

BEFORE INSTALLATION

Unpack your fan and check the contents. You should have followings:



- 1. Hanger 2. Motor 3. Motor shell 4. Blade 9. Light Kit
- 5. Blade screw 6. Decorative cover 7. Receiver 8. Remote control

				
1/4*15 screw 6	Balance sticker 2	Explosion screw 4	Gasket 6	Self-tapping screws 4

INSTALL THE FAN

Tools Required: Phillips Screwdriver, Pair of Pliers, Straight slot screwdriver, Adjustable Wrench, Step Ladder and Wire Cutters.

INSTALL THE MOUNTING BRACKET

To prevent personal injury and damage, ensure that the hanging location allows the blade a clearance of 7.5 feet (2.3 metets) from the floor and 18 inches (45.72 centimeters) from any wall or obstruction.

1. For the concrete ceiling: Mark the location for the ceiling fan first, then drill two holes in the ceiling to aid in securing ceiling bracket with two expansion screws provided, and secure the mounting bracket to the building structure with two expansion screws provided, tighten the screws. (Fig.1)

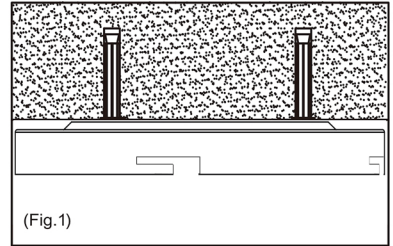

For the Wood Ceiling: Mark the location for the ceiling fan first, secure the mounting bracket to the building structure with four wood screws provided. (Fig.2)

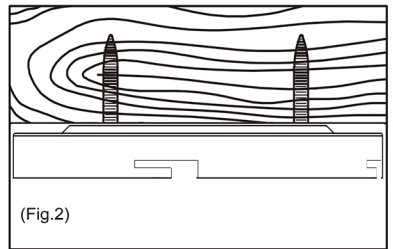

NOTE: Hanger after the installation must be able to withstand the weight of 45 kgs or more.

INSTALLING RECEIVER

Install ceiling fan, follow the steps below:

1. Install the motor: unscrew the four screws of the ceiling mounting bracket, connect the motor to the ceiling mounting bracket and lock it with the screws.
2. Install the remote control: Connect the wires on the motor and the wires on the receiver to the corresponding colors. (Please refer to the remote control manual)
3. Install the shell: put the shell on the motor, rotate it to the right, and clamp it on the mounting bracket.

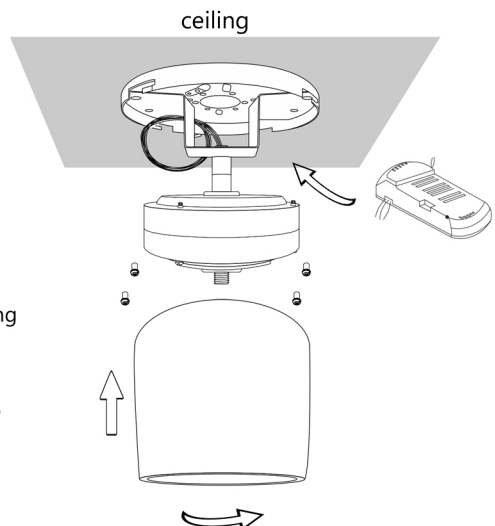

INSTALLATION WITHOUT LAMP

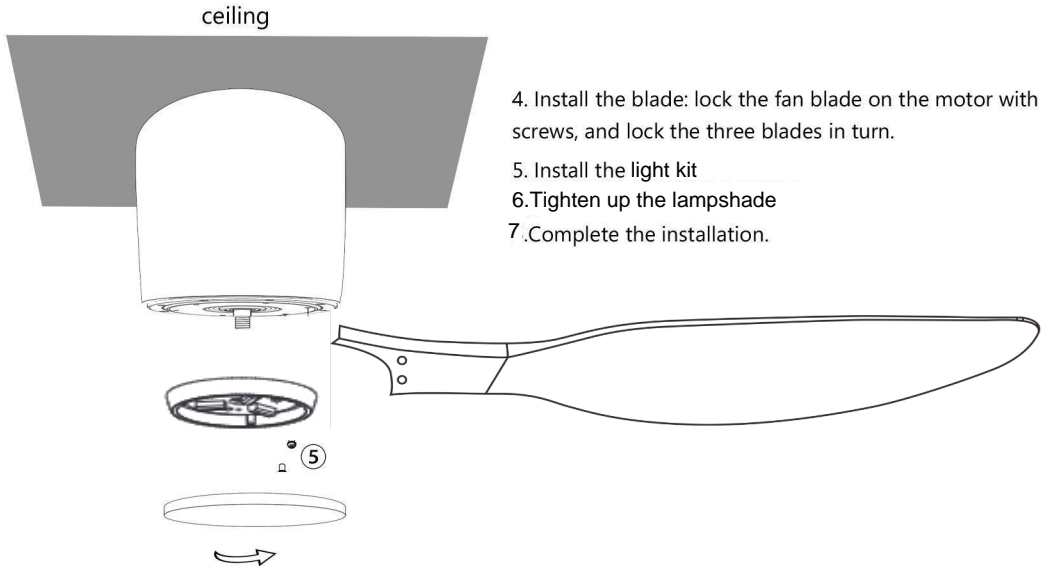

Controller wiring diagram

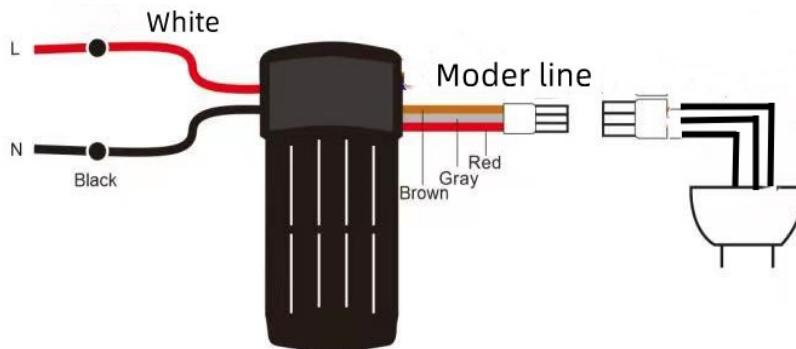

Introduction to Remote Control Functions

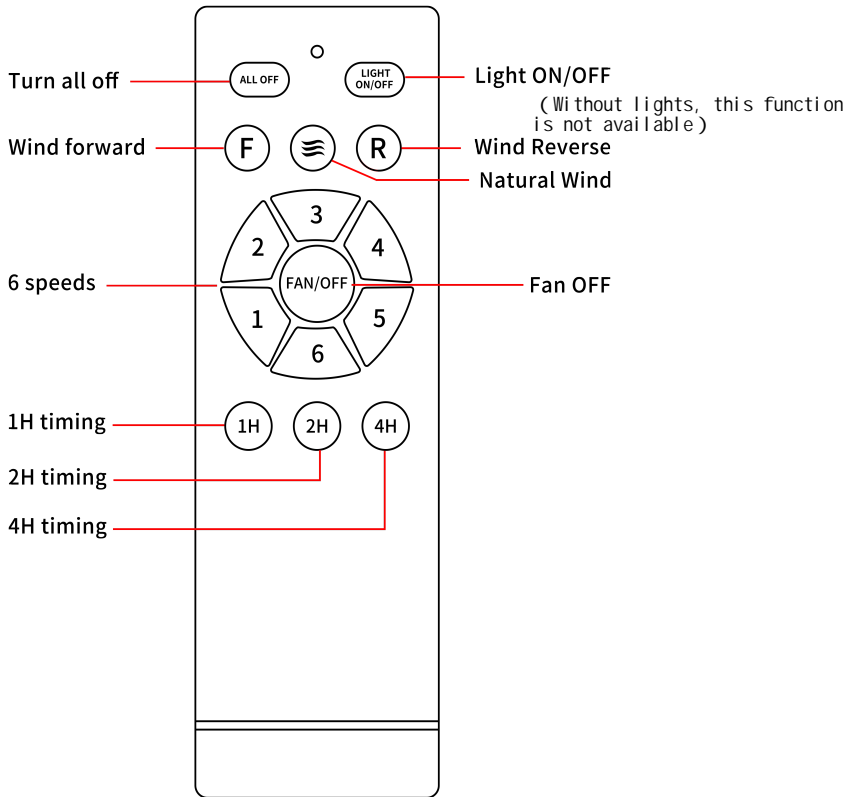

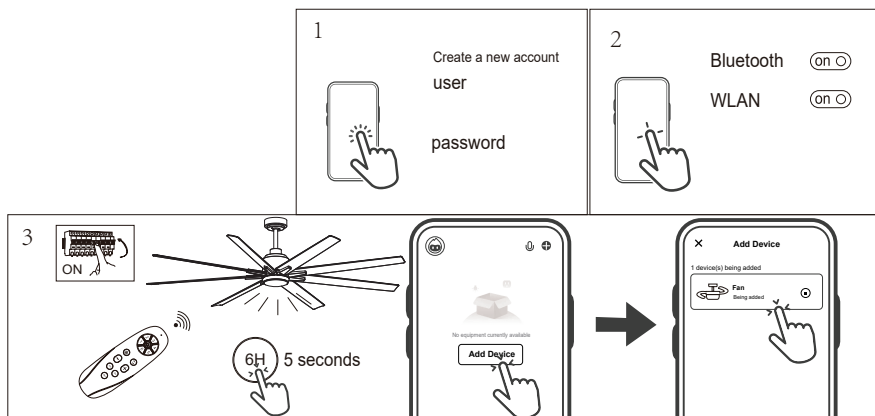

1-Search and download the App Store, Google play.

2-Install and open the app.

3.1 Open your App account.

3.2 Create a new account:

→ input your mobile number or email address.

→ click to get the verification code (check your mail box).

→ input the verification code.

→ set login password.

→ accept the permissions.

→ you have your account created.

4- Turn on Bluetooth and WiFi , connect WiFi (Note: WiFi can only use 2.4G router)

5- **Link the ceiling fan:** Open App,then turn on the power supply of the fan controller and press and hold the “6h” button of the remote control handle for about 5 seconds within 10 seconds after the fan is powered on. At this time, click Add device in the App main interface, the light will flash and the connection icon of the fan will appear on the App interface.

Next click “Add device” button.Then you can enter the mobile phone control interface to control the fan (Note: When Bluetooth matching, the fan motor cannot be in working state).

NOTES

1. Please check whether the WIFI account and password information are correct.

2. Reducing the distance between mobile phone, router and an receiver can connect more faster, otherwise it may cause connection failure.

Troubleshooting



WARNING: Make sure the power is off at the electrical panel box before you attempt any repairs.

Problem	Solution
The fan will not start.	<input type="checkbox"/> Check the main and branch circuit fuses or breakers.
	<input type="checkbox"/> Check the line wire connections to the fan and switch wire connections in the switch housing.
	<input type="checkbox"/> Check to make sure the frequency switches from the remote control and receiver are set to the same frequency.
The fan sounds noisy.	<input type="checkbox"/> Make sure all motor housing screws are snug.
	<input type="checkbox"/> Make sure the screws that attach the fan blade to the motor hub are tight.
	<input type="checkbox"/> Make sure the wire nut connections are not rattling against each other or the interior wall of the switch housing.
	<input type="checkbox"/> Allow a 24-hour "breaking-in" period. Most noises associated with a new fan disappear during this time.
	<input type="checkbox"/> If using the ceiling light kit, make sure the glassware is secured tightly.
	<input type="checkbox"/> Make sure there is a short distance from the ceiling to the canopy. It should not touch the ceiling.
The remote control is not working.	<input type="checkbox"/> Make sure your ceiling box is secure and that rubber isolator pads are used between the mounting bracket and outlet box.
	<input type="checkbox"/> Make sure the frequency switches are set correctly.

Balancing – Wobbling problems during fan operation

If the fan body wobbles during its operation, this is not a sign of malfunctioning (even if it wobbles a few centimeters). To reduce wobbling, you can turn off the fan, and:

1. Check that all blades are properly fastened by tightening their screws.
2. Check the distance between each blade and the ceiling. Measurements to the ceiling can be carried out as shown in the following diagram. If variations exist and you have already correctly tightened the screws, check that all blades have the same shape. If any of them have a shape that is visibly different, this may be causing an imbalance during fan operation.

If you have completed the previous steps and the wobbling has not resolved, you should apply dynamic balancing with the kit provided, as explained below:

1. Turn the fan on to the highest speed so that the greatest amount of wobbling is produced.
2. Turn off the fan. Select a blade and place a clip on it (see diagram) halfway between the fastening and the far edge of the blade.
3. Turn on the fan and check whether the wobbling has improved or gotten worse. Turn it off once again and if the wobbling has not improved, place the clip on another blade. Repeat this process and determine on which blade it improves the wobbling.
4. Leave the clip on the blade that produces the best results. Move the clip forward or backwards on this blade until finding the position that offers the best results.
5. Afterwards, remove the clip and place one of the weights on the upper part of the center line of the blade at the position where the clip was located.

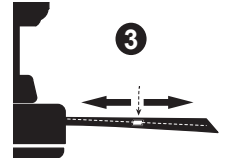
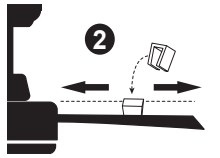
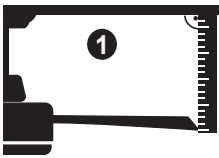

Ceiling Fan

Retain this manual for future use.