







CABINET		
A		1
B		2
C		2
D		2
E		8
F		1



A+C+E+F

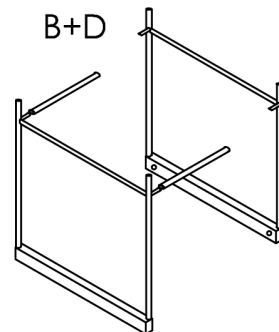
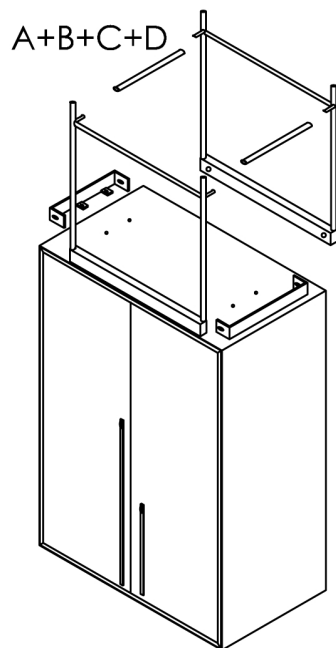
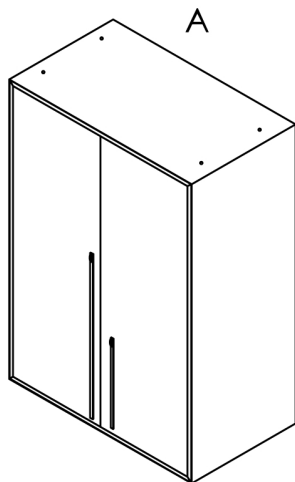