

20'

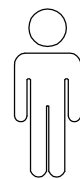

2

B x 2

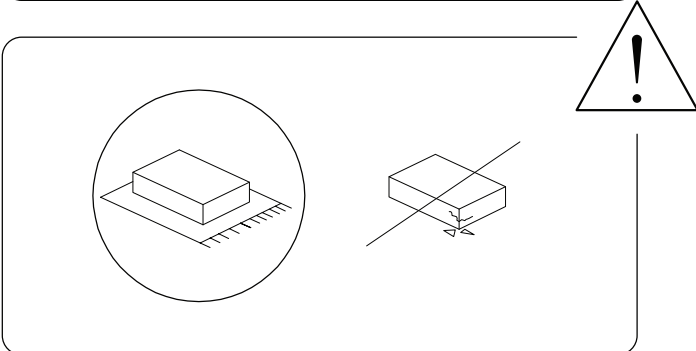
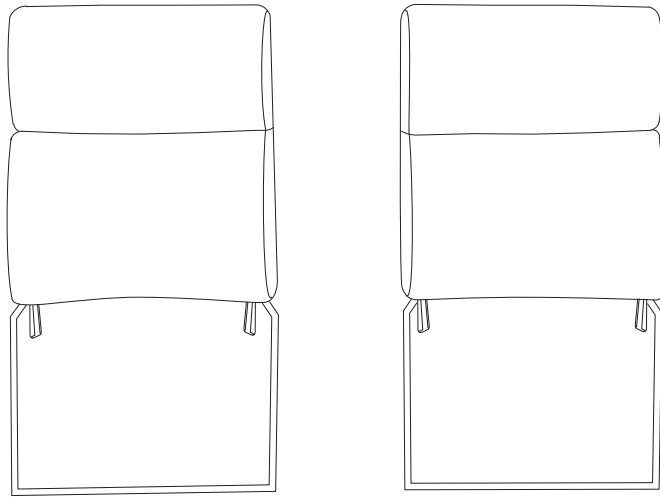

A

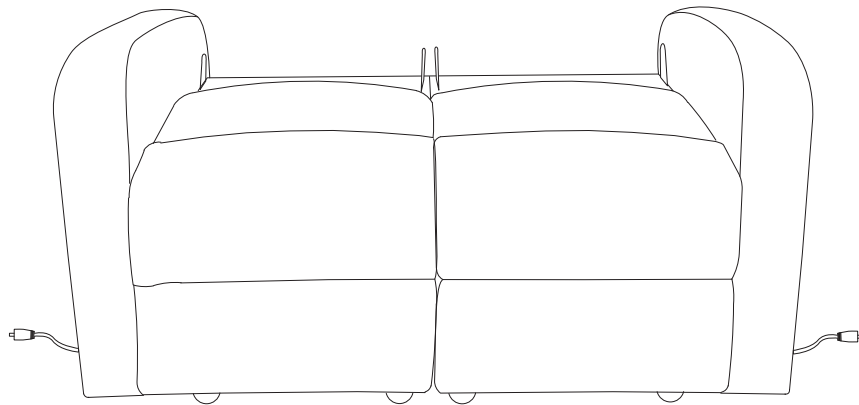

A

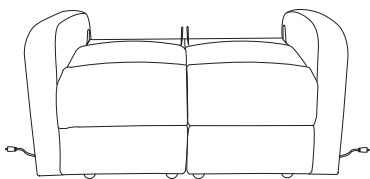

x 1

B

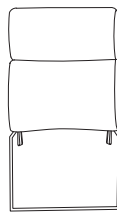

x 2

C



x 2

1

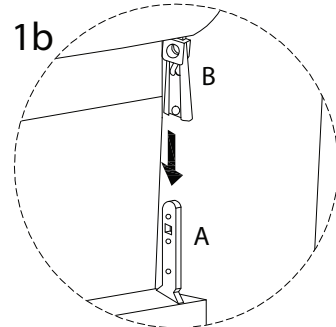
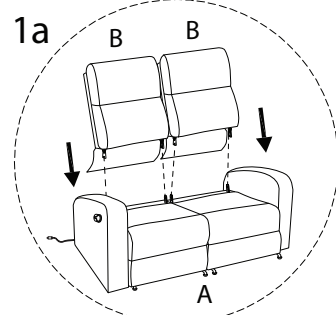
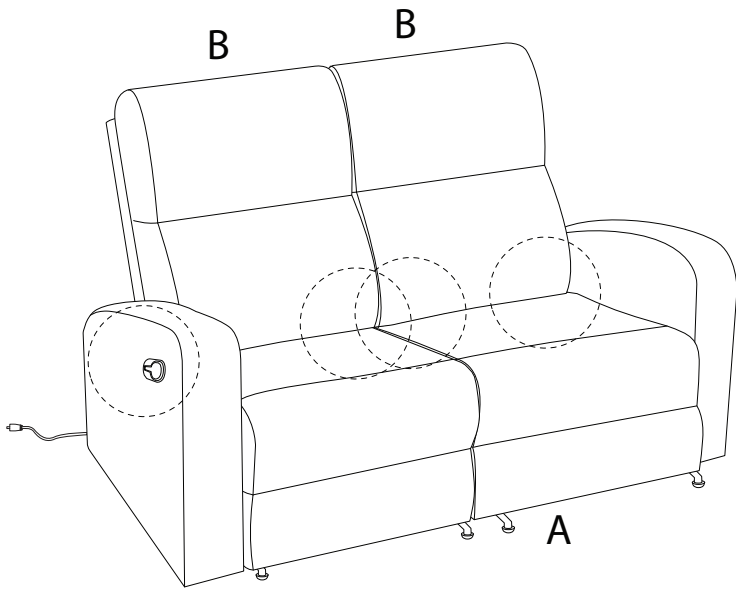
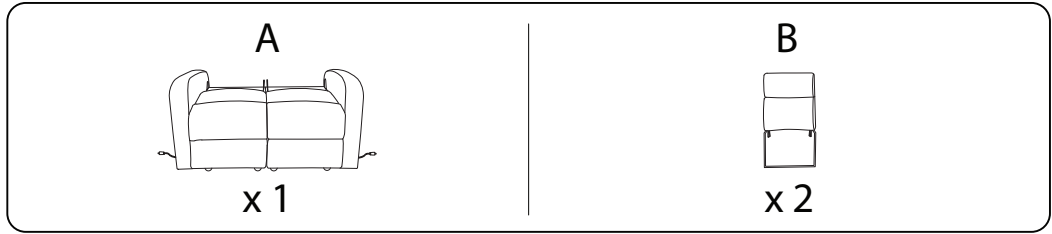

2

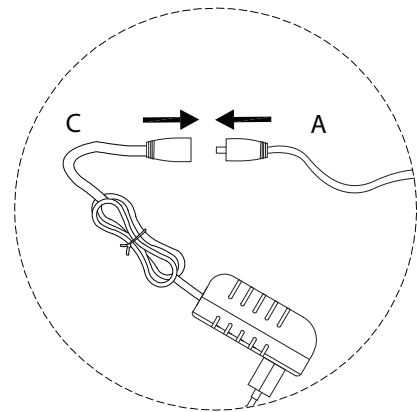
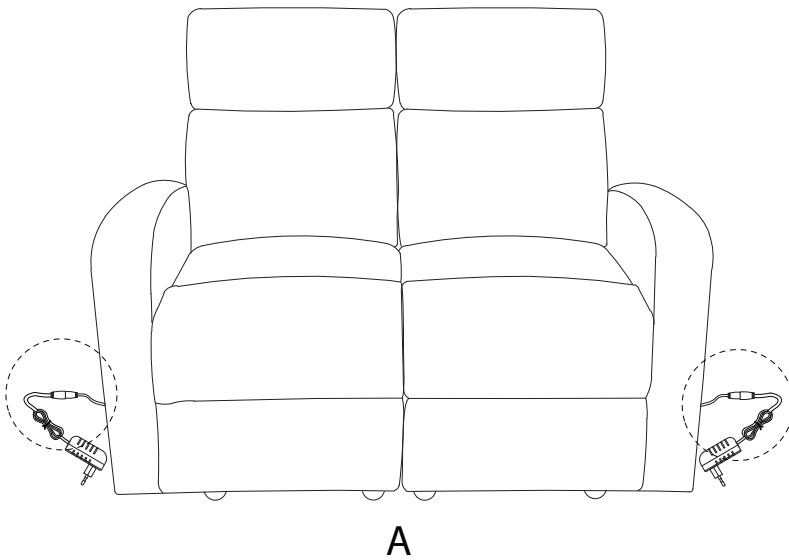
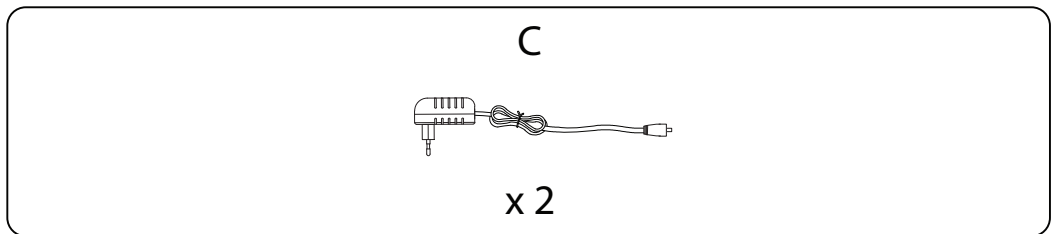

3

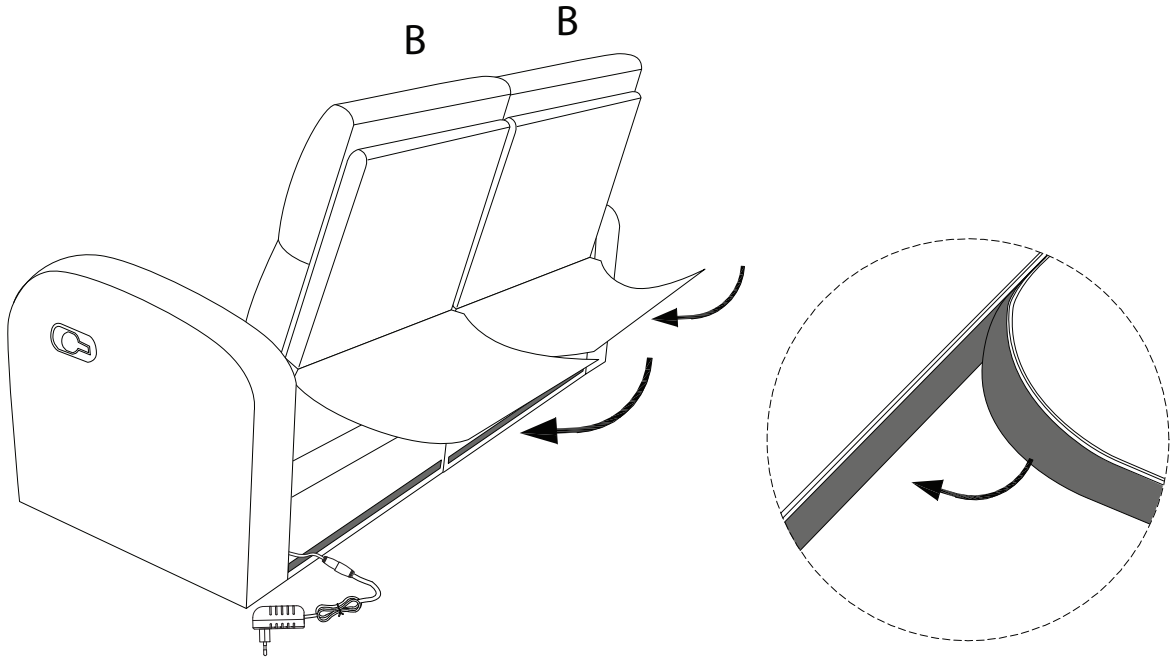

!

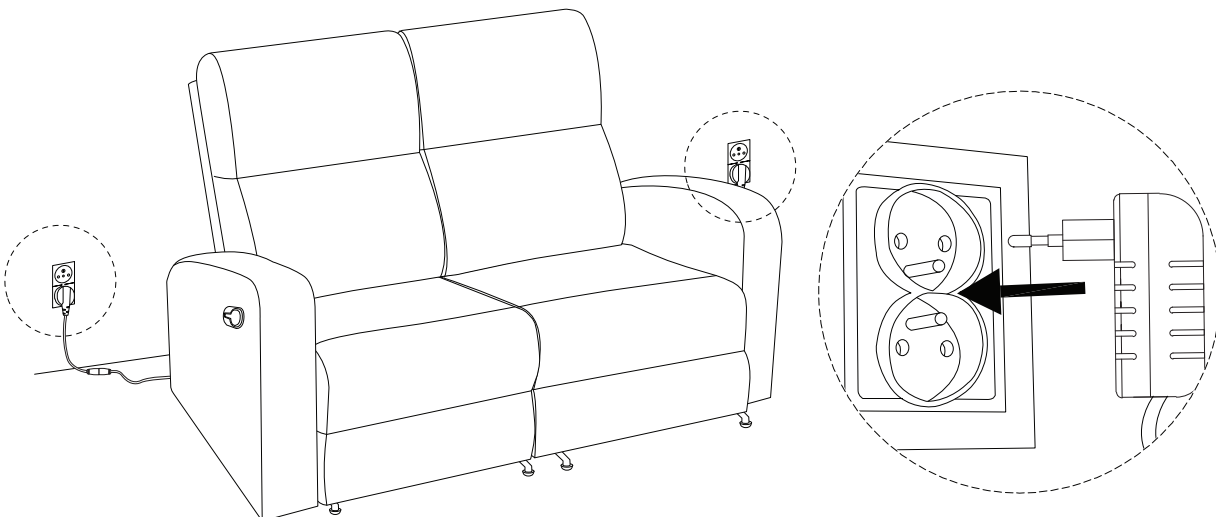

!

