

FULLY ASSEMBLE:

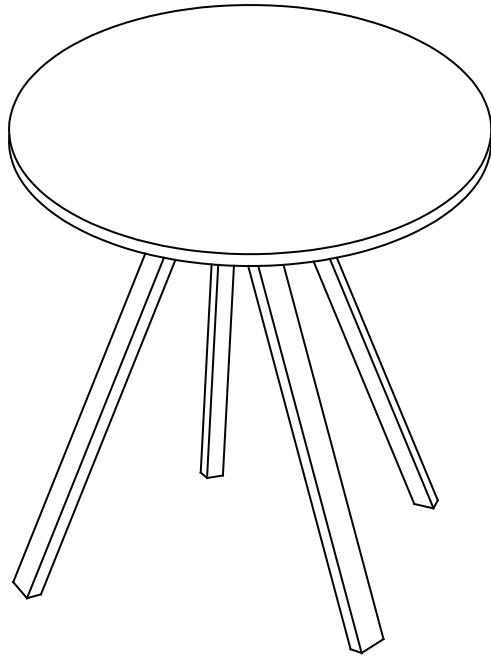

WARNING:



Please avoid unbalance loads on top of the table.



The product should only be used on firm, level ground.



Please periodically check all fittings and re-tighten as necessary.

Assembly Instruction

4-Leg Round Smart Top Table

00:30

Approx. 30 minutes





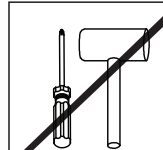

Recomm. 2 Person

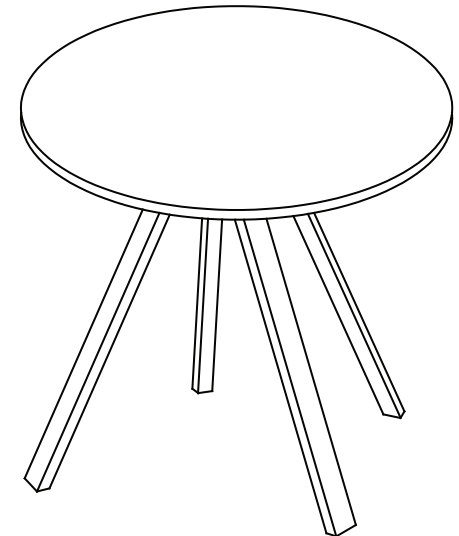





No Tools Required

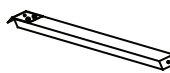

No	Hardware List	Qty.
1	JCBB M 8 X 30 MM 	12
2	M5 ALLEN KEY 	2
3	SPRING WASHER 	12
4	FLAT WASHER 	12

No	Part List	Qty.
A	TABLE 	1
B	LEG 	4

HARDWARE REMOVE FROM STEP 1

No	Hardware List	Qty.
1	JCBB M 8 X 30 MM 	8
3	SPRING WASHER 	8
4	FLAT WASHER 	8
5	JCN NUT M8 X 20 	8
6	METAL PLATE 	4

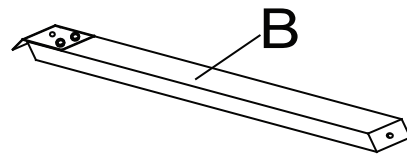
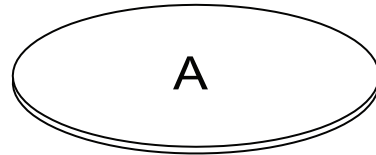

USEFUL HINTS BEFORE YOU START:

1. Read each step carefully before starting.
2. It is important that each step is performed in correct order to avoid difficulties.
3. Identify, sort and count the parts before assembly.
4. Assemble your furniture on packaging cardboard to prevent scratch or damage.
5. Clean the product with mild cleanser using soft damped cloth. Do not use harsh or abrasive cleanser.
6. Using incompatible hardware might cause damage to product.

STEP 1

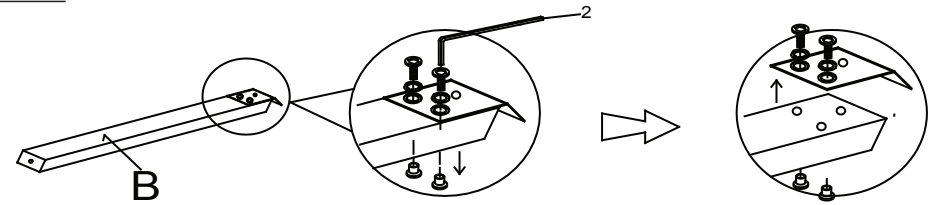

STEP 2

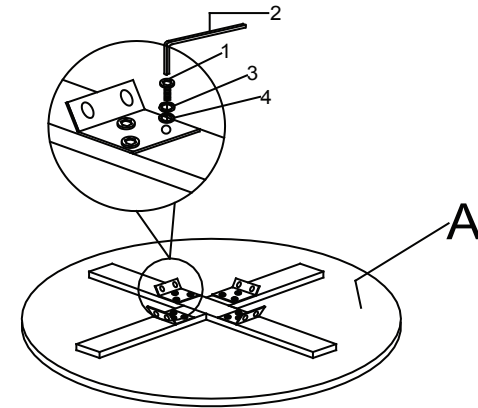

STEP 3

