

# 577, 578 & 579 Cabinet Knobs Series

Finishes for Life  
TARNISH-FREE GUARANTEED

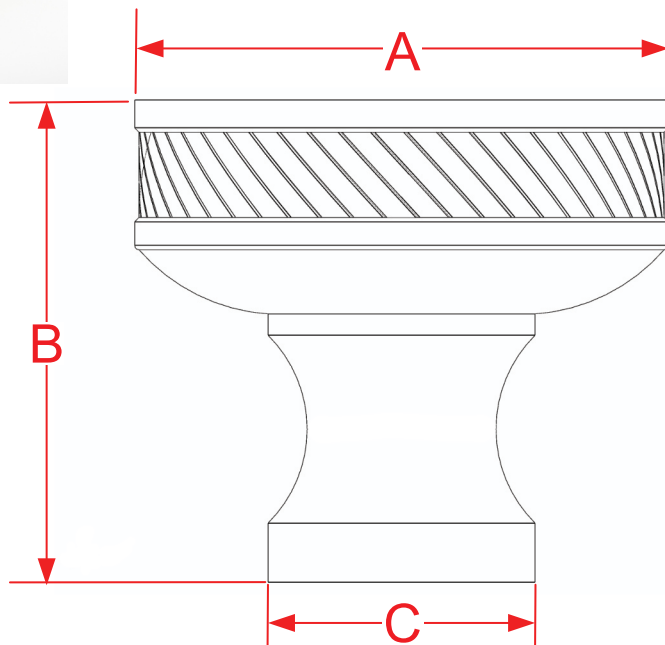

	A	B	C
Part #	Diameter	Projection	Base
577	1.0000"	1.0625"	0.5000"
578	1.2500"	1.1250"	0.6250"
579	1.5000"	1.1875"	0.7880"
Custom Sizing Available			



Manufacturing Fine Architectural Hardware  
in the USA Since 1927



Copyright  
Colonial Bronze Company  
All rights reserved  
[www.colonialbronze.com](http://www.colonialbronze.com) -  
860.489.9233