

W00123

LOFT BED ASSEMBLY INSTRUCTIONS

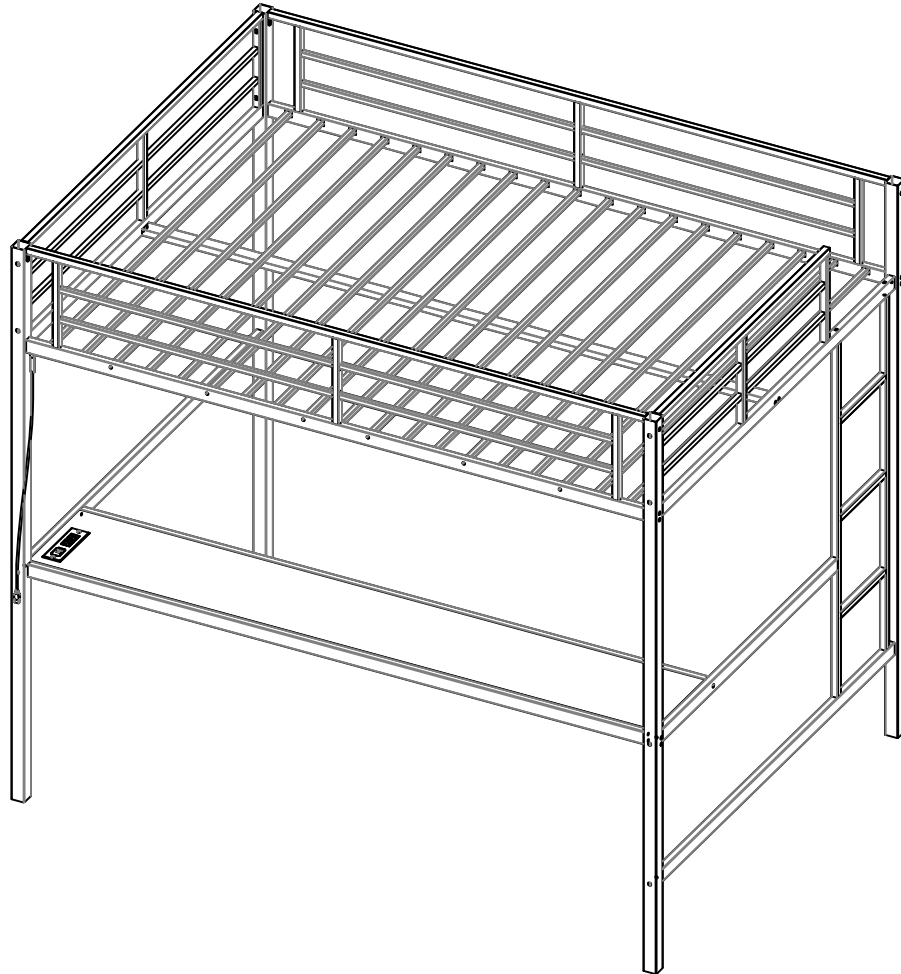

SAFETY WARNINGS AND GENERAL NOTES:

1. Follow the information on the warnings on the bunk bed end structure and on the carton. Do not remove the warning label from the bed.
2. Always use the recommended size mattress on mattress support, or both, to help prevent the likelihood of entrapment or falls.
3. Do not allow children under 6 years of age to use the upper bunk.
4. Periodically check and ensure the guardrail, ladder and other components are in their proper position, free from damage, and all connectors are tight.
5. Do not allow horseplay on or under beds.
6. Always prohibit jumping on the bed.
7. Prohibit more than one person on upper bunk.
8. Always use the ladder for entering and leaving the upper bunk.
9. Do not use substitute parts. Contact the manufacturer or dealer for replacement parts.

10. Use of a night-tight may provide added safety precaution for a child using the upper bunk.

11. Always use guardrails on both long sides of the upper bunk.
12. If the bunk bed will be placed next to a wall, the guardrail that runs the full length of the bed should be placed against the wall to prevent entrapment between the bed and the wall.

The use of water or sleep flotation mattresses is prohibited.

13. **STRANGULATION HAZARD**-Never attach or hang items to any part of the bunk bed that are not designed for use with the bed; for example, but not limited to, hooks, belts and jump ropes.

14. Keep these instructions for future reference.

15. We recommend assembling your bunk bed on the shipping carton to protect your floor or carpet.

16. Be certain all staples are out of the box before beginning assembly on the shipping carton.

17. USE ONLY MATTRESSES WHICH ARE AS THE TABLE BELOW ON UPPER AND ON LOWER BUNKS.

Up bed (bunk bed and tribed included)

Mattress size	Length	Width	Thickness
Full xl Standard	79"-60"	53"-54"	6" max

18. SURFACE OF MATTRESS MUST BE AT LEAST 5"(127MM) BELOW THE UPPER EDGE OF GUARDRAILS.

19. Replacement Parts:

Replacement Parts, including additional guardrails, may be obtained from any of our (Shenzhen Yuefeng Zhiqi Technology Co., Ltd) dealers.

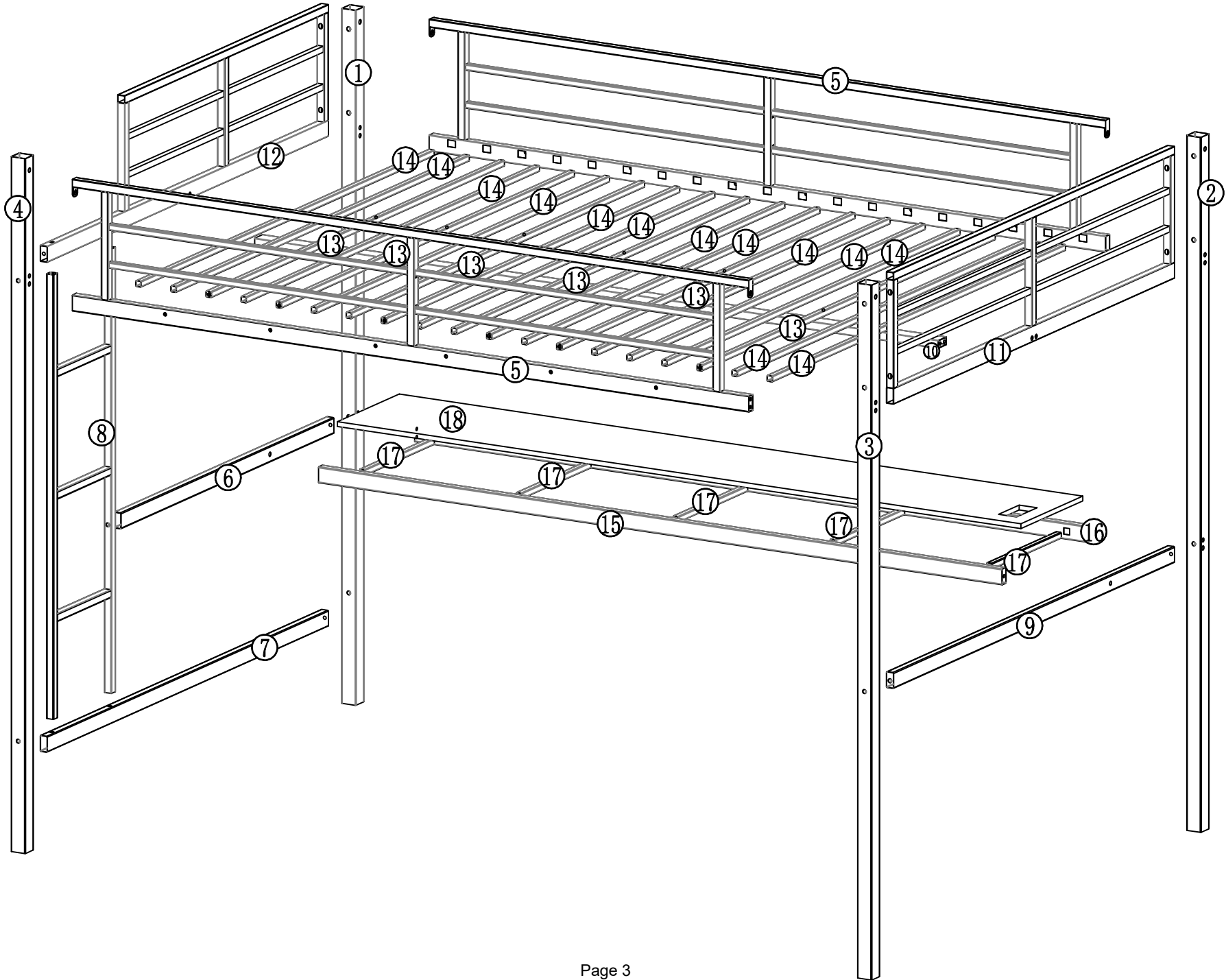

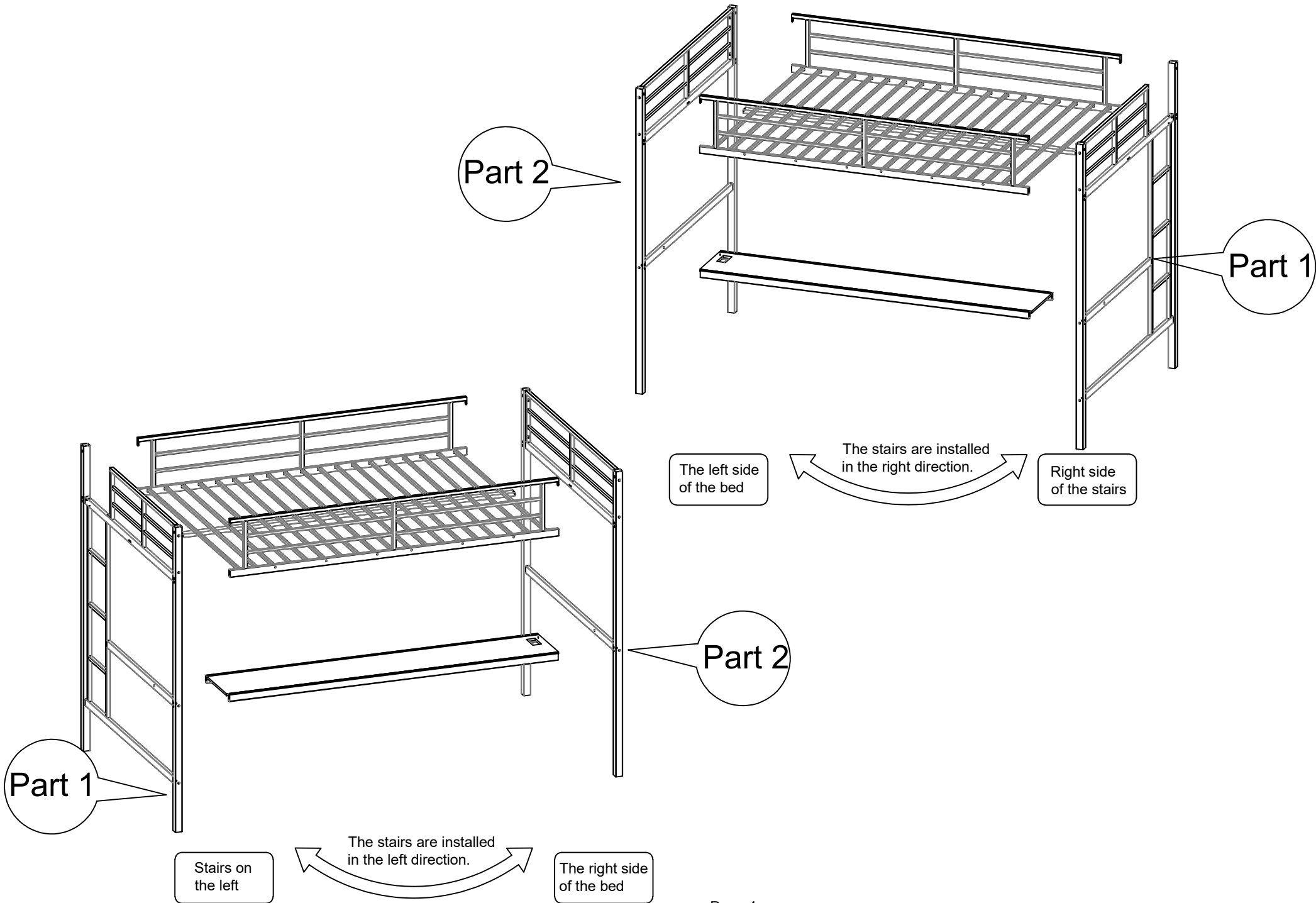

Part List

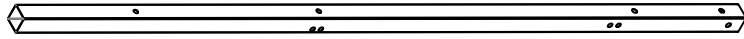

1-1pcs

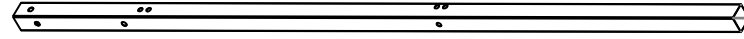

2-1pcs

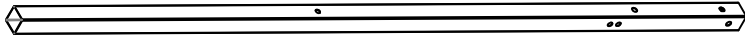

3-1pcs

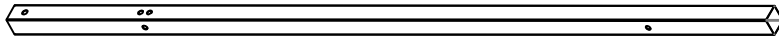

4-1pcs

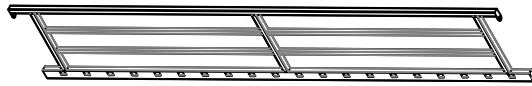

5-2pcs

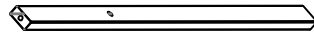

6-1pcs

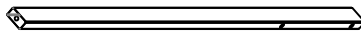

7-1pcs

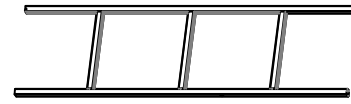

8-1pcs

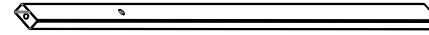

9-1pcs



10-1pcs

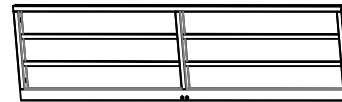

11-1pcs



12-1pcs



13-6pcs



14-14pcs

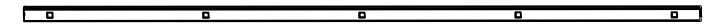

15-1pcs



16-1pcs















17-5pcs



18-1pcs

Hardware List

		P Socket lpcs		Q Light strips lpcs	
					
A	C	D	E	O	F
4*10 2PCS	8*35 11PCS	8*55 28PCS	6*30 18PCS		8*15-10PCS
					
					M
					
					T
					4PCS
					
					U
					2PCS
					
					N
					40PCS
					
					L1
					
					L2
					
					K
					40PCS

Step 1: Use hardware C,D,F and L to connect #1, #4,#8,#6,#7 and #12 together.

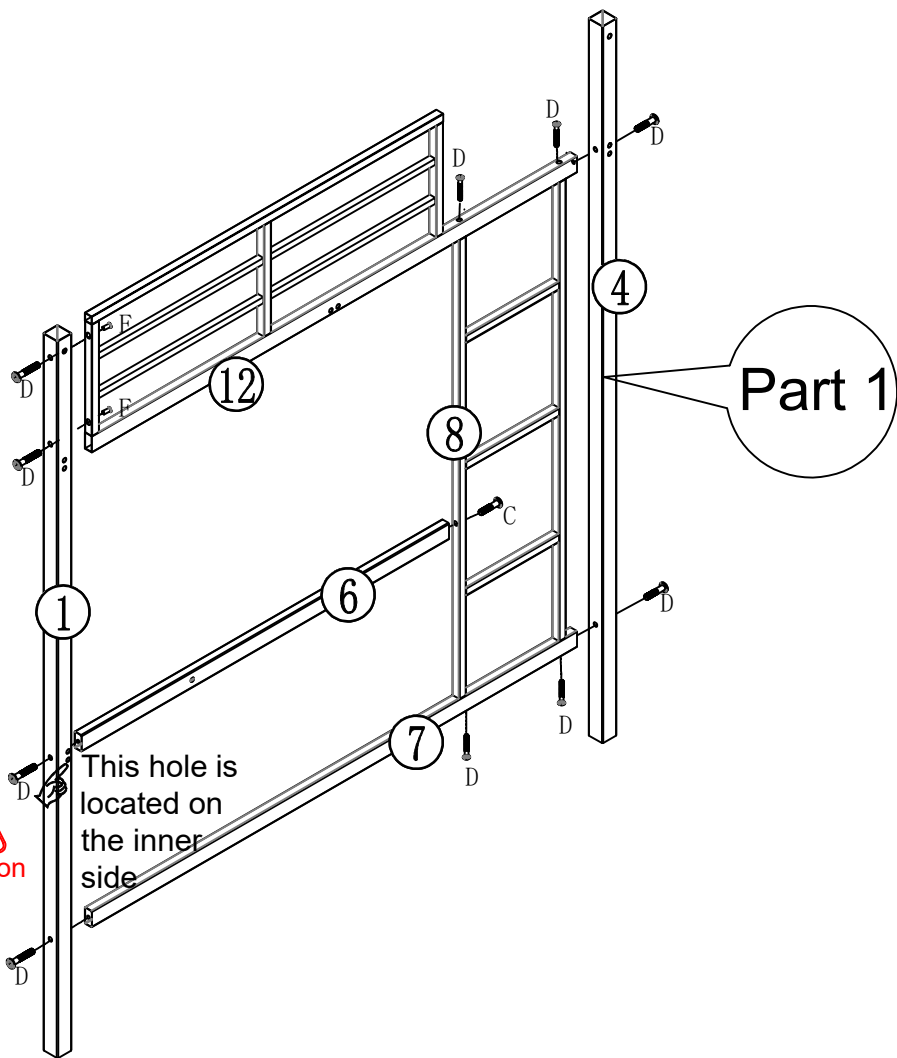

Step 2: Use hardware D,F and L to connect #2, #3,#9 and #11 together.

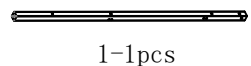
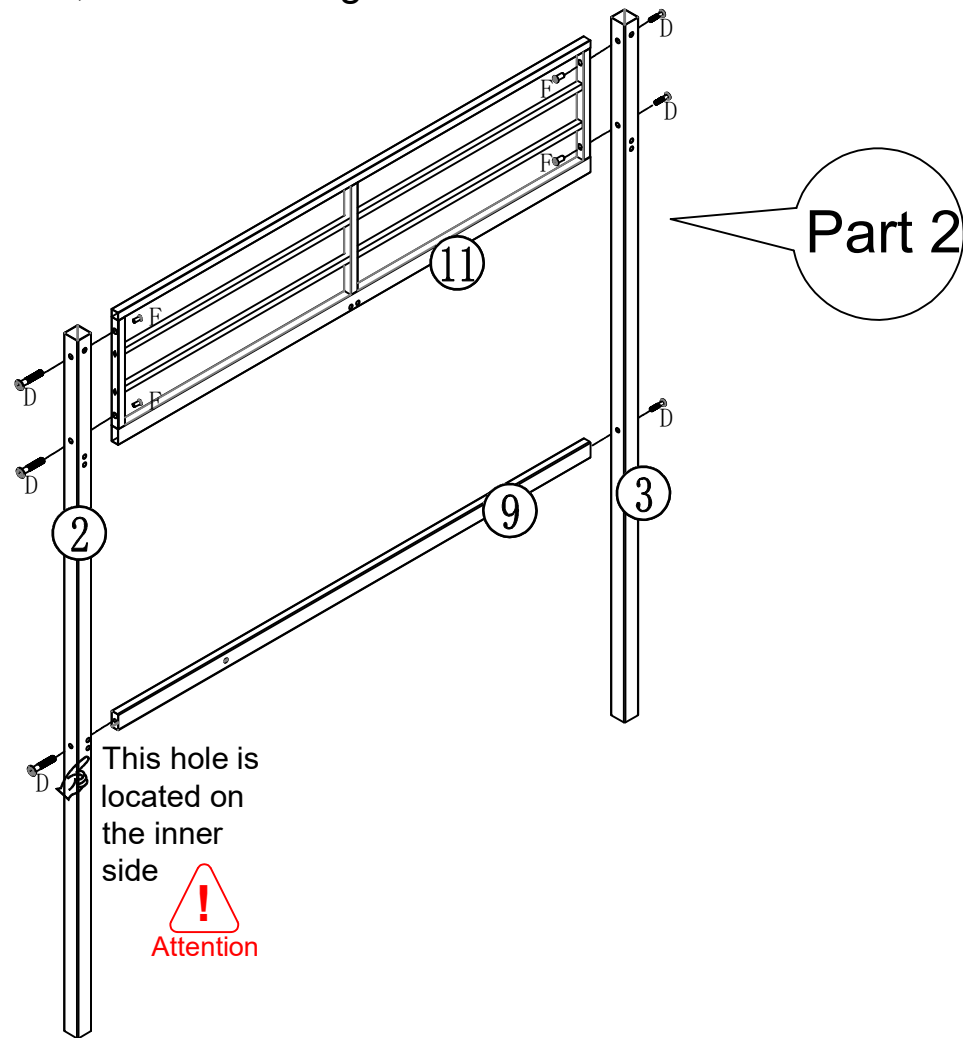

1-pcs

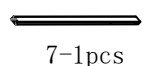

7-pcs



8*35-1PCS



8*55-10PCS



8*15-2PCS

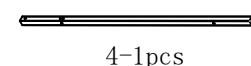

4-pcs

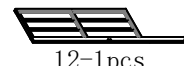

12-pcs

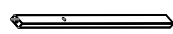

6-pcs



8-pcs



L

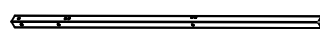

2-pcs



11-pcs

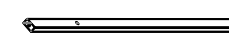

9-pcs

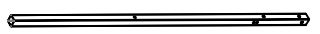

3-pcs



8*55-6PCS



8*15-4PCS



L

Step 3: Install part #K to parts #5 together.

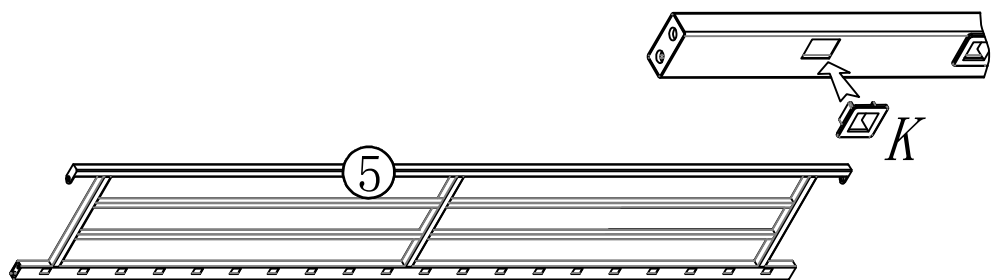

Please assemble **2** sets

Step 4: Use hardware D,F,C and L to connect #5, #16 and #10 together.

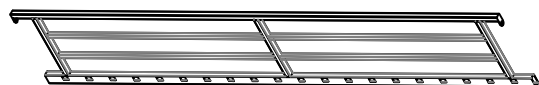
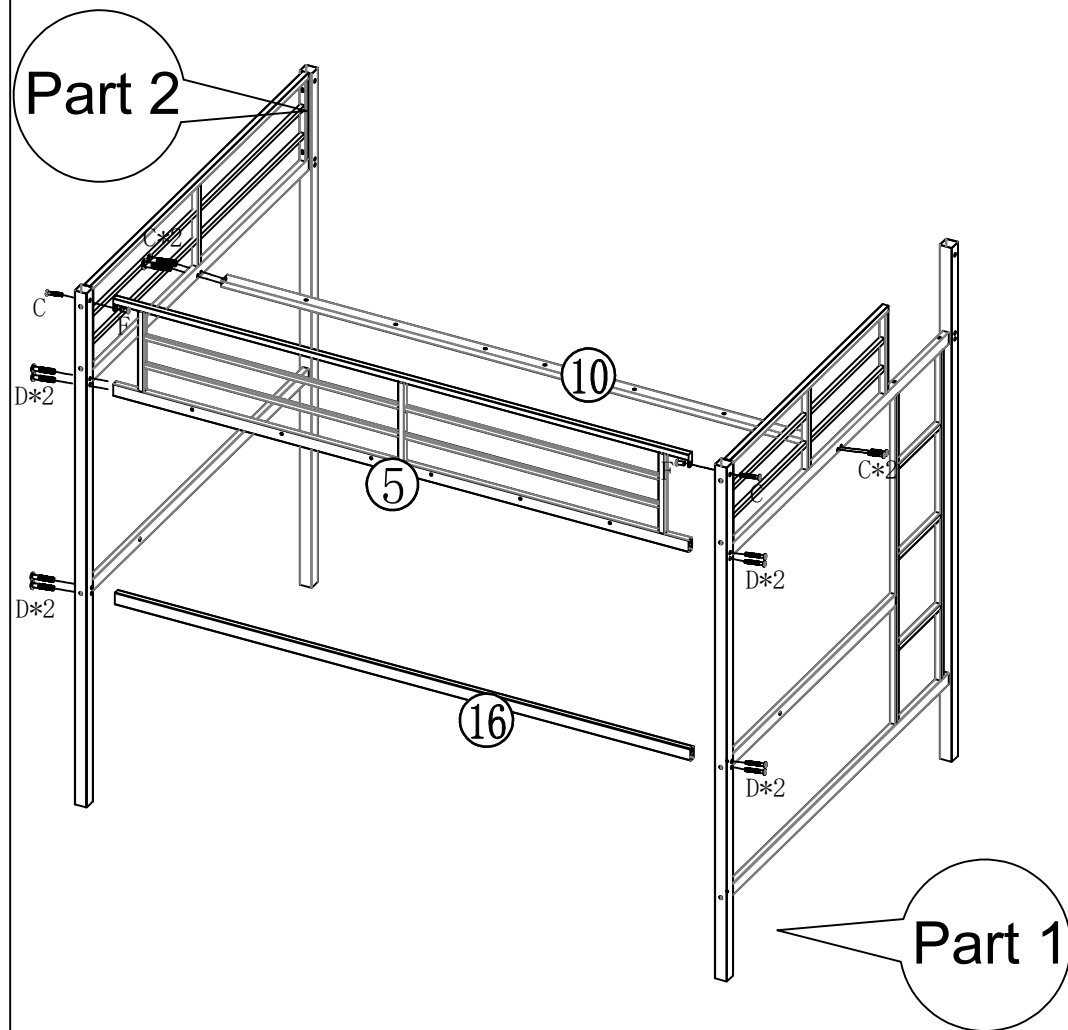

5-2pcs



K

40PCS



5-1pcs

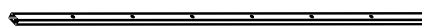

10-1pcs



16-1pcs



D
8*55-8PCS



C
8*35-6PCS



F
8*15-2PCS



L



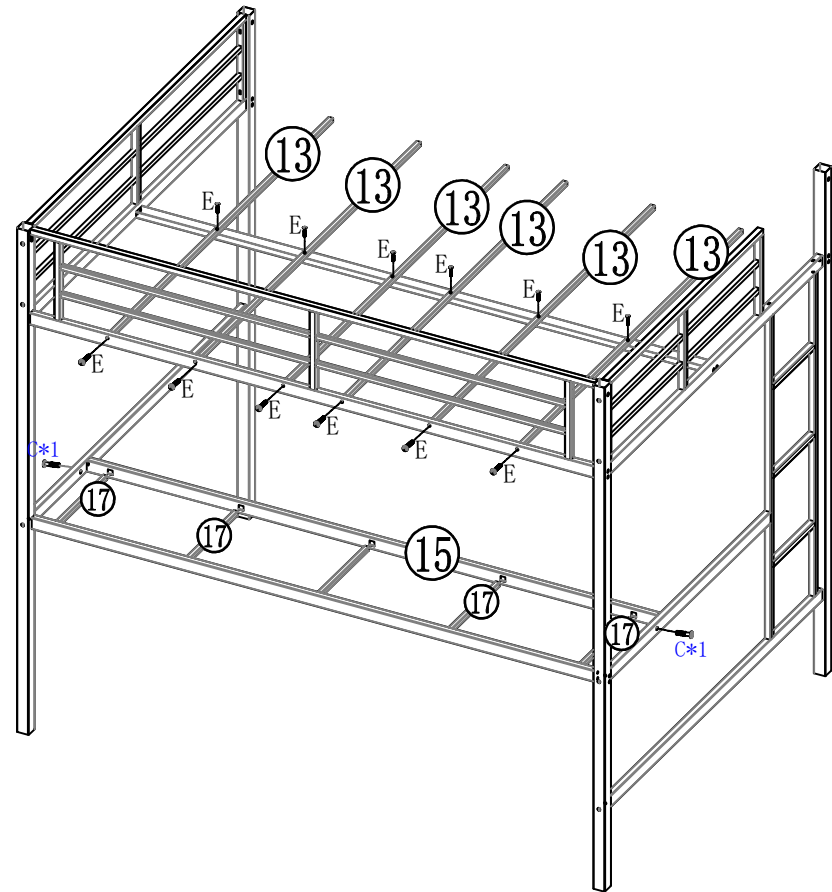

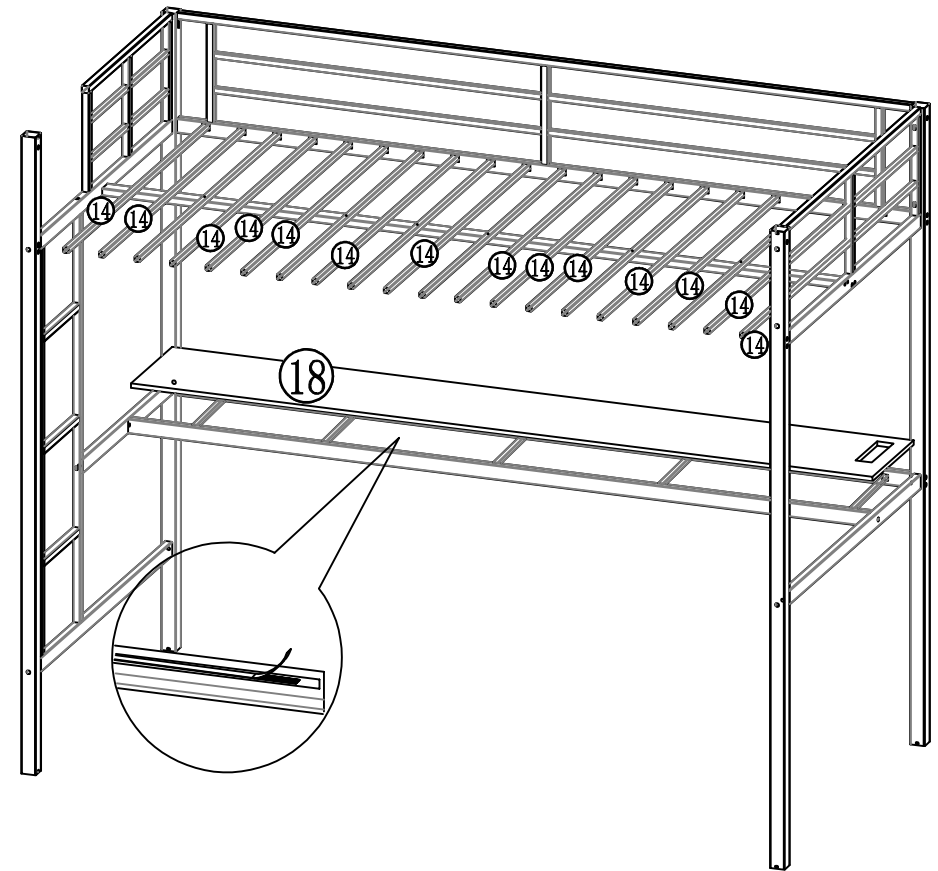

Step 4: Use hardware E,C and L to connect #13, #17 and #15 together.



Step 5: Connect #14, #18 to the previously installed components.



Please tear off the adhesive tape before placing the board.

 13-6pcs	 17-5pcs	 L	 E 6*30-12PCS
 15-1pcs		 C 8*35-2PCS	

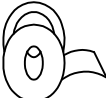
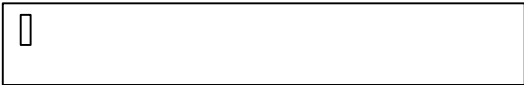
 14-14pcs	 O
 18-1pcs	

Step 7: Use hardware E,D,F,C and L to connect #5 together.

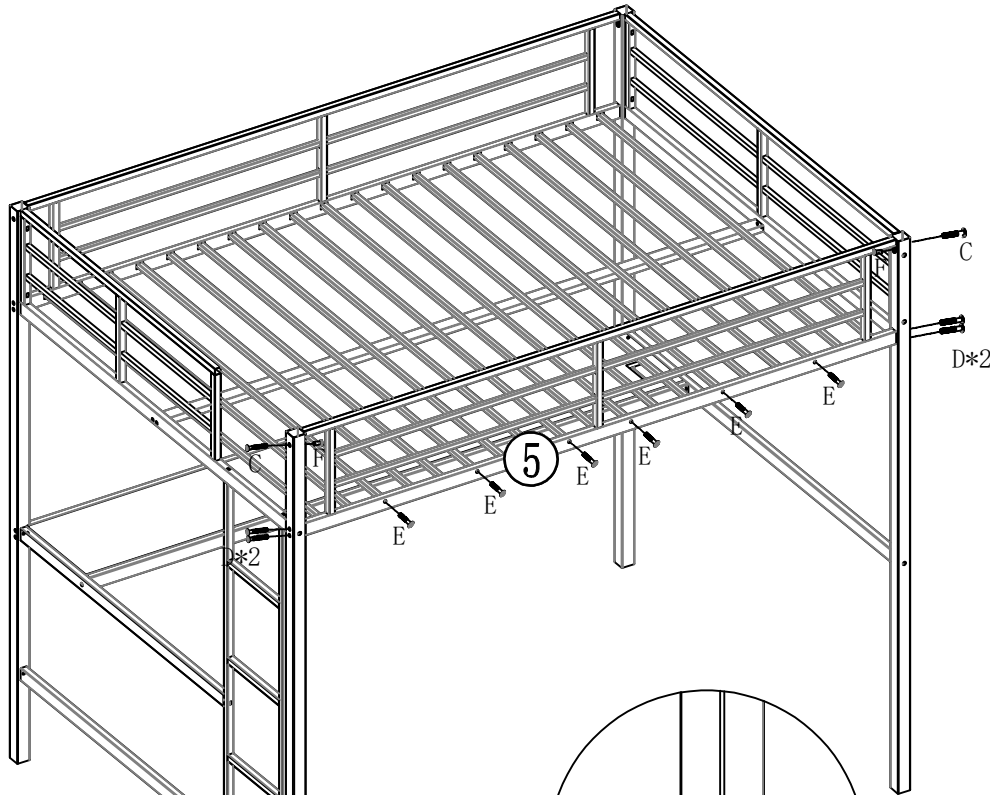

Tips:
If you feel that the bed is a little wobbly then please use the parts "U" and "T" for reinforcement

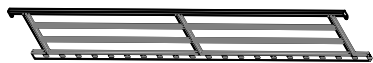
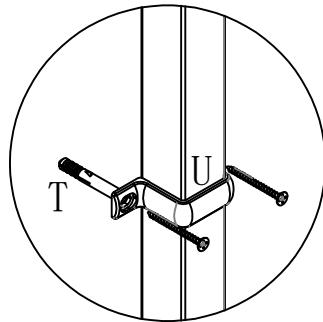

5-1pcs

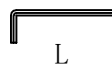

L



E
6*30-6PCS



C
8*35-2PCS



D
8*55-4PCS



F
8*15-2PCS

Completed loft bed

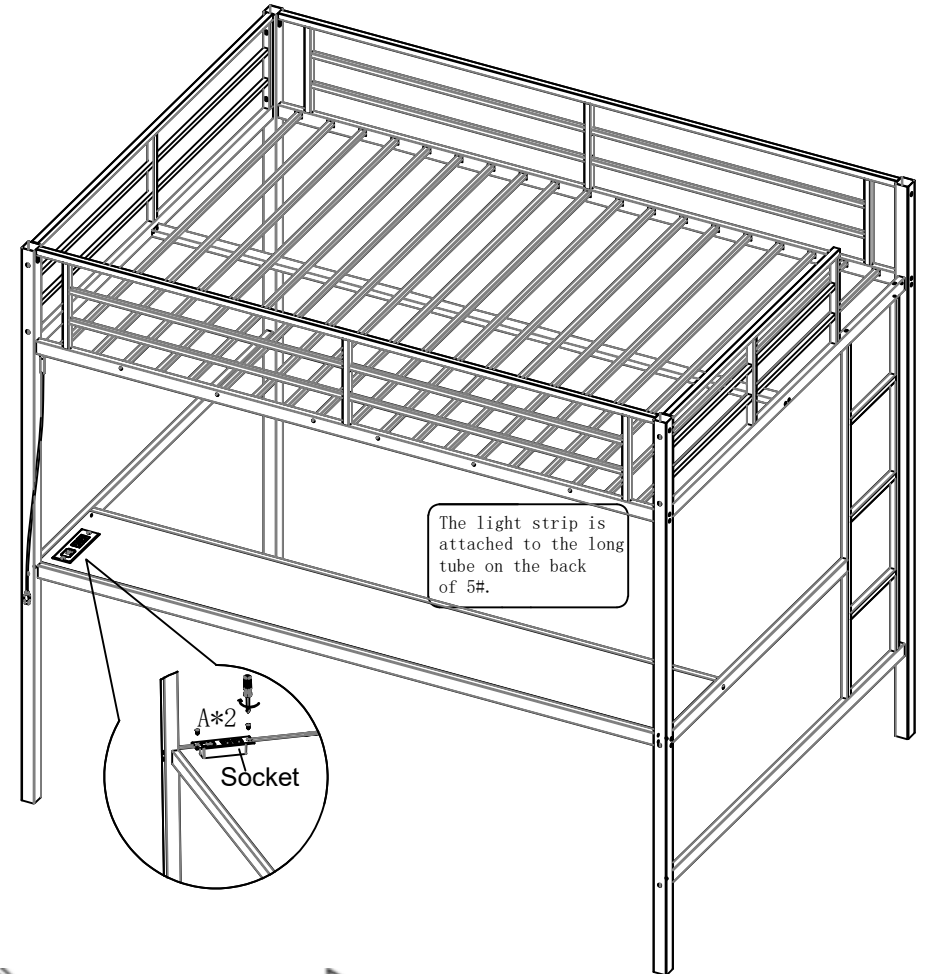

The light strip is attached to the long tube on the back of 5#.

Socket

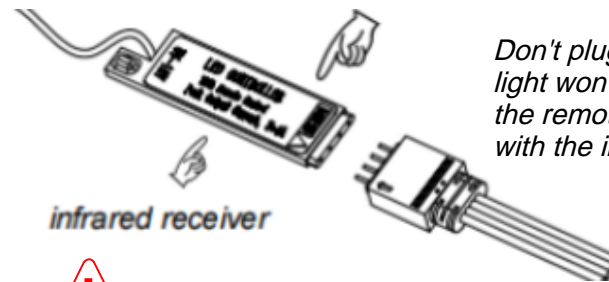

infrared receiver

Don't plug it in the wrong way, or the light won't work and when operating the remote control should be aligned with the infrared receiver.



Attention

Please tighten all screws before use, thank you.