

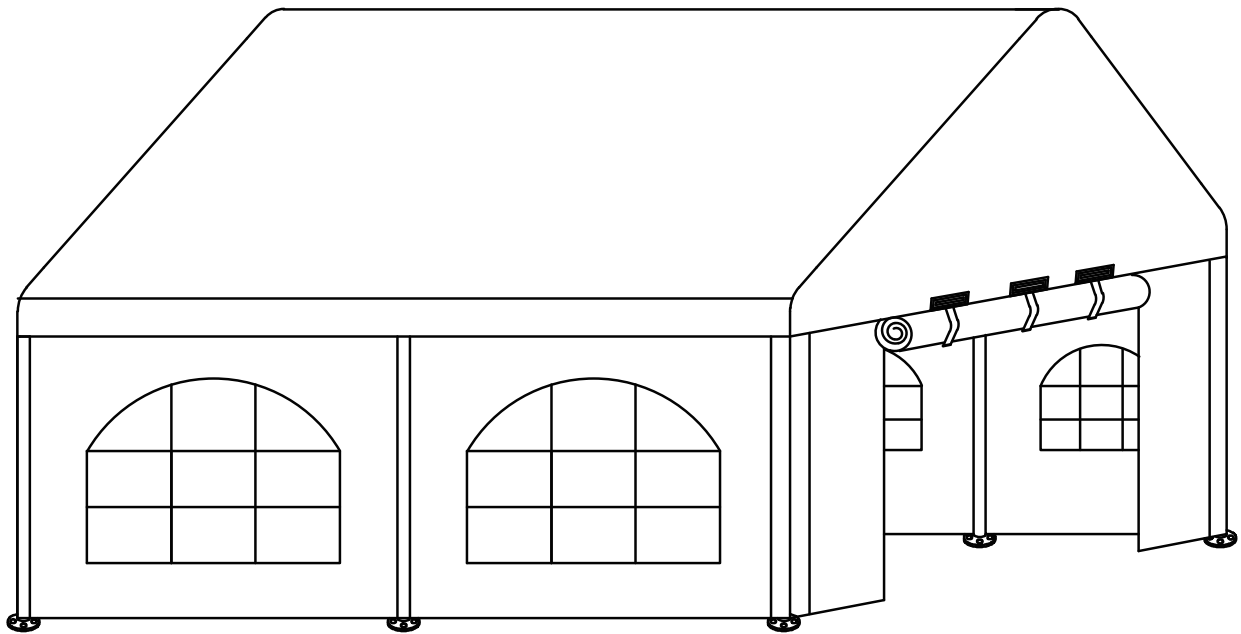

IN221000401V01_GL

84C-375V00_84C-375V30



EN_IMPORTANT, RETAIN FOR FUTURE REFERENCE: READ CAREFULLY.

FR_IMPORTANT: A LIRE ATTENTIVEMENT ET À CONSERVER POUR CONSULTATION ULTÉRIEURE.

ES_IMPORTANTE, LEA Y GUARDE PARA FUTURAS REFERENCIAS.

PT_IMPORTANTE, RETER PARA REFERÊNCIA FUTURA: LEIA ATENTAMENTE.

DE_WICHTIG! SORGFÄLTIG LESEN UND FÜR SPÄTER NACHSCHLAGEN AUFBEWAHREN.

IT_IMPORTANTE! CONSERVARE IL PRESENTE MANUALE PER FUTURO RIFERIMENTO E LEGGERLO ATTENTAMENTE.

EN

1. multi-person assembly is required for this tent.
2. Please take appropriate actions as heavy rain, wind and snow can damage the tent. If necessary please dis -assemble and store for later use.
3. In snowy conditions please do not allow the thickness of the snow to be more than 5cm on the roof, this should be cleared as soon as possible for your safety.

FR

1. multi-personnes minimum requis pour le montage de la tente.
2. Veuillez faire attention lorsque vous utilisez la serre en périodes de fortes pluies, vent ou neige : la serre pourrait être endommagée. Si nécessaire, veuillez démonter la serre afin de pouvoir la réutiliser plus tard.
3. Pour votre sécurité, en période de neige, il est recommandé de ne pas laisser de neige de plus de 5cm sur le toit.

ES

1. Se requieren varias personas para realizar el montaje de esta tienda de campaña.
2. Por favor, tome las medidas oportunas ya que la lluvia, el viento y la nieve pueden dañar la tienda. Si es necesario, desmonte la tienda y guárdela para su uso posterior.
3. En condiciones de nieve, no permita que la nieve tenga más de 5 cm de espesor en el techo, y retírela tan pronto como sea posible para su seguridad.

PT

1. Para a montagem desta tenda de campismo são necessárias multi-pessoas.
2. Tome medidas adequadas, em caso de vento forte, chuva ou neve, pois estas podem danificar a tenda. Caso seja necessário, desmonte e armazene a tenda de campismo para uso posterior.
3. Em caso de neve, não permita que a espessura da neve seja superior a 5cm no teto. Para a sua segurança, retire a neve o mais rápido possível

DE

1. Dieses Zelt muss von mehreren Personen aufgebaut werden.
2. Bitte ergreifen Sie geeignete Maßnahmen, da starker Regen, Wind und Schnee das Zelt beschädigen können. Falls nötig, bauen Sie es bitte ab und bewahren Sie es zur späteren Verwendung auf.
3. Bei Schneefall darf die Schneehöhe auf dem Dach nicht mehr als 5 cm betragen, diese sollte zu Ihrer Sicherheit so schnell wie möglich beseitigt werden.

IT

1. Per assemblare questa tenda sono necessarie multi-persona
2. Si prega di prendere le precauzioni necessaria in quanto pioggia, vento e neve possono danneggiare la tenda. Se necessario si prega di smontarla e conservarla per uso futuro.
3. Qualora nevicasse si prega di non lasciare che lo strato di neve sopra la tenda sia spesso oltre i 5cm, anzi la neve va rimossa al più' presto per la vostra sicurezza.

① x 6

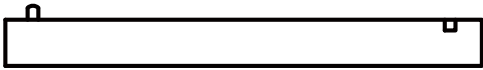

② x 6

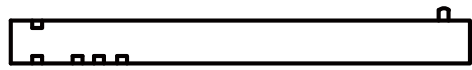

③ x 6

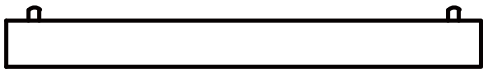

④ x 6

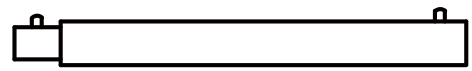

Q x 2

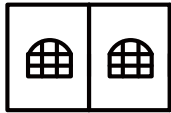

R x 2

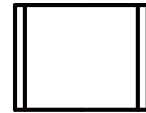

A x 6



B x 3

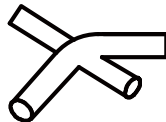

G x 6



H x 12



J x 4



K x 72



M x 6

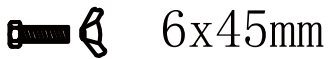

P x 1

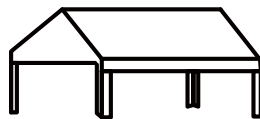

S x 4



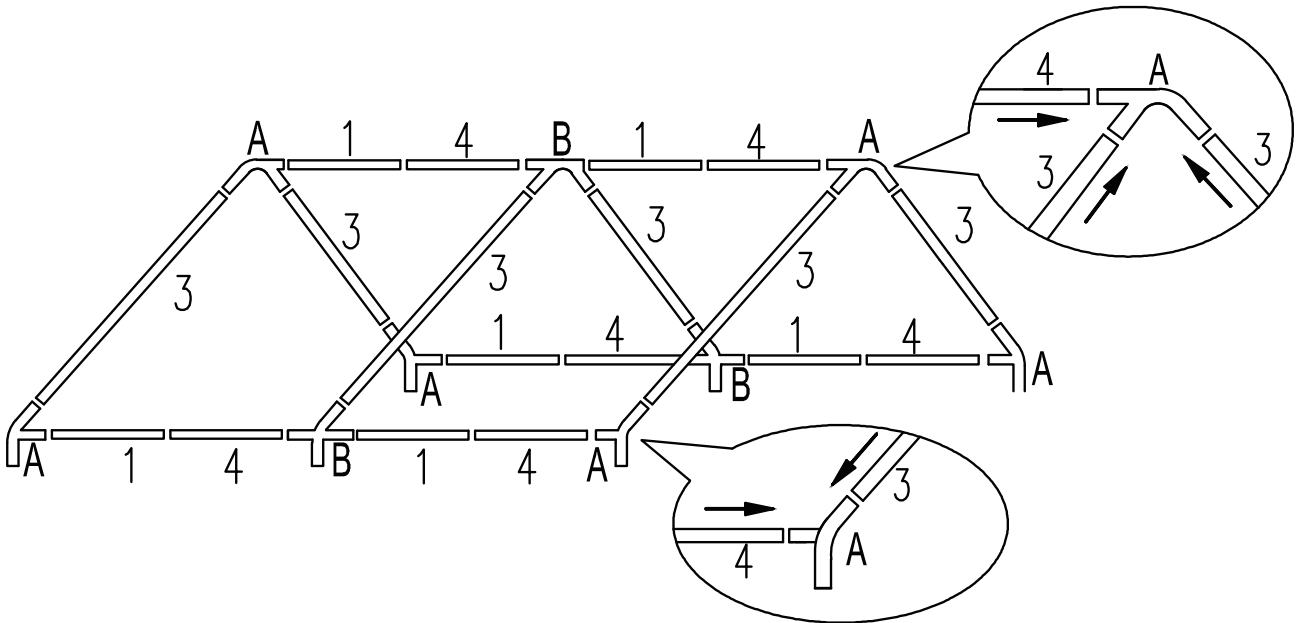
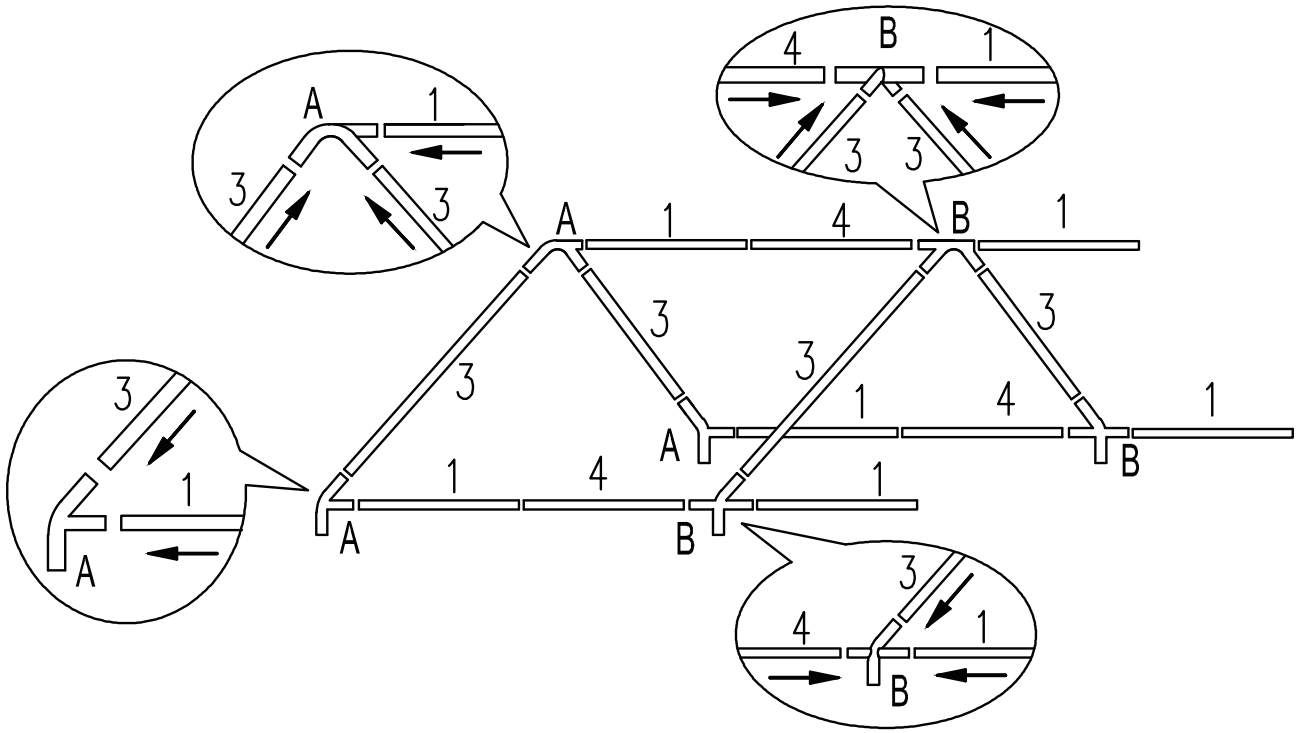

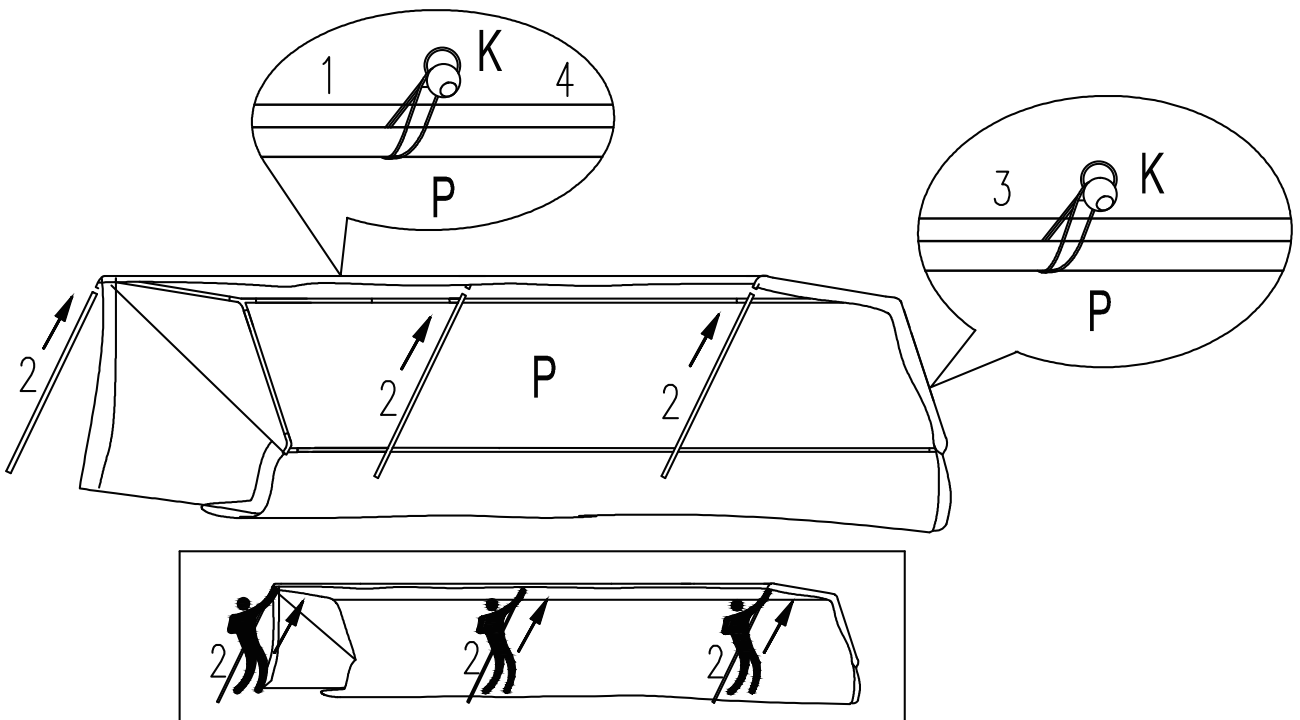
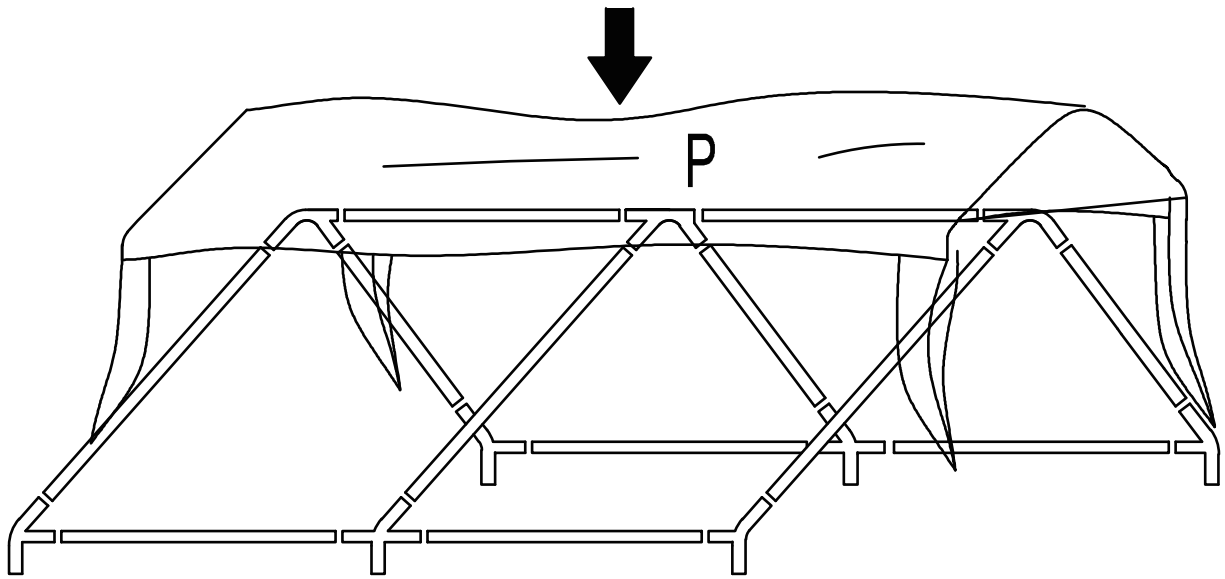

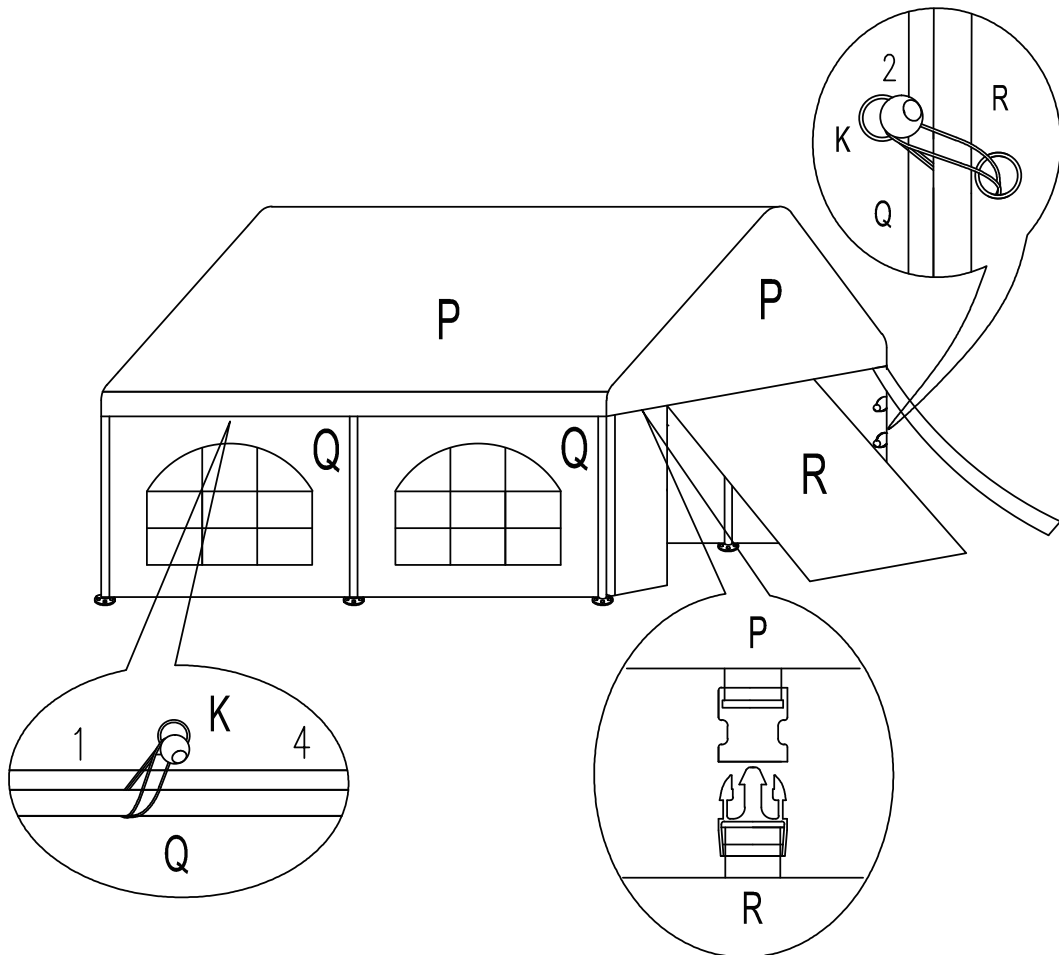
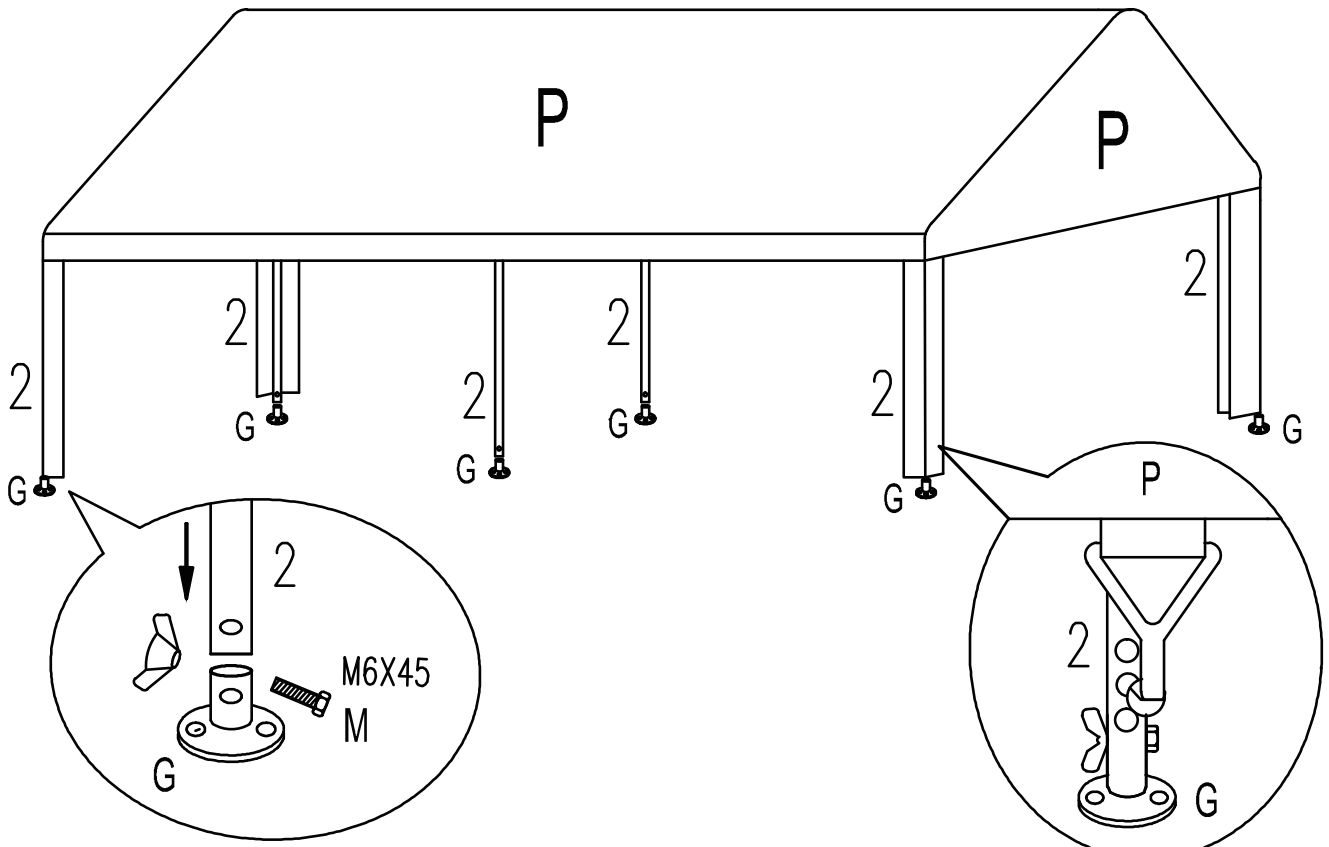

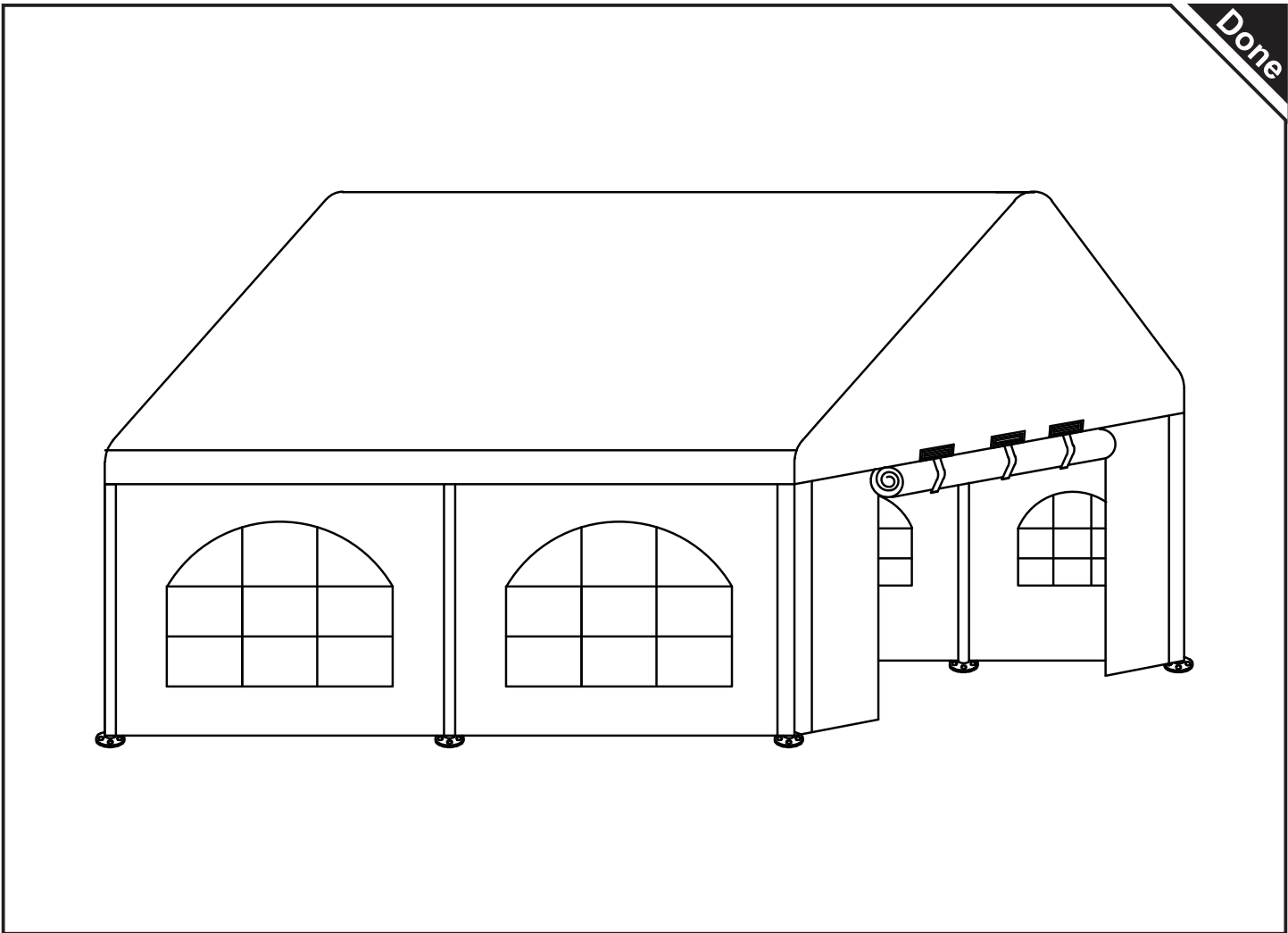
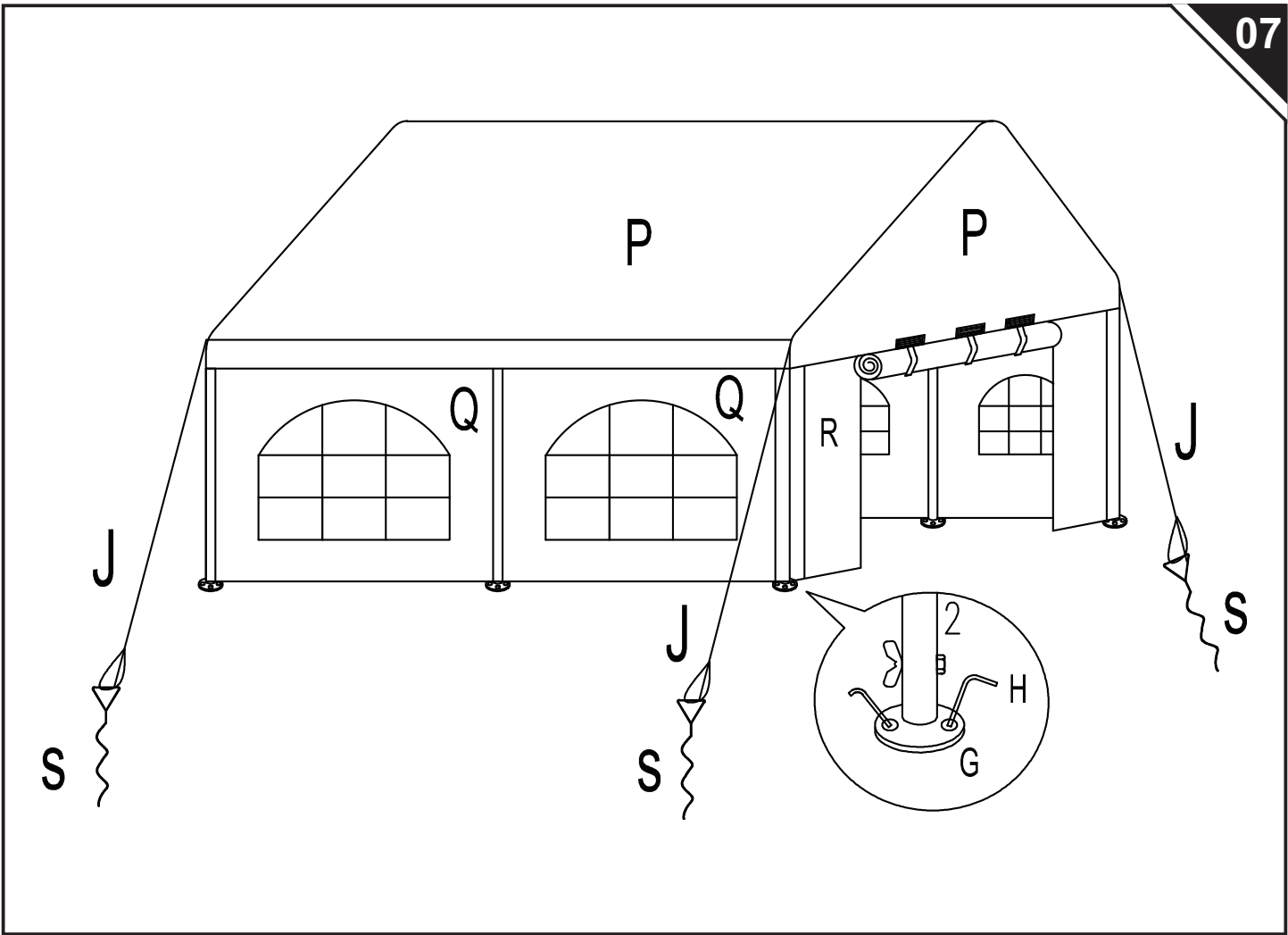

If you have any questions, please contact our customer care center, Our contact details are below:

US

 001-877-644-9366

 customerservice@aosom.com

Imported by Aosom LLC
27150 SW Kinsman Rd Wilsonville, OR 97070 USA
MADE IN CHINA

If you have any questions, please contact our customer care center, Our contact details are below:

CA

 416-792-6088

 customerservice@aosom.ca

Imported by Aosom Canada Inc.
7270 Woodbine Avenue, Unit 307, Markham,
Ontario Canada L3R 4B9
MADE IN CHINA

Si vous avez la moindre question, veuillez contacter notre centre d'assistance à la clientèle, Nos coordonnées sont les suivantes:

 416-792-6088

 customerservice@aosom.ca

Importé par Aosom Canada Inc.
7270 Woodbine Avenue, unité 307,
Markham, Ontario Canada L3R 4B9
FABRIQUÉ EN CHINE

If you have any questions, please contact our customer care center, Our contact details are below:

UK

 0044-800-240-4004

 enquiries@mhstar.co.uk

IMPORTER ADDRESS:
MH STAR UK LTD
Unit 27, Perivale Park,
Horsenden lane South
Perivale, UB6 7RH
MADE IN CHINA

Si vous avez la moindre question, veuillez contacter notre centre d'assistance à la clientèle, Nos coordonnées sont les suivantes:

FR

 0033-1-84166106

 aosom@mhfrance.fr

Importé par/Fabricant/REP:
MH FRANCE
2 Rue Maurice Hartmann
92130 Issy Les Moulineaux
France
FABRIQUÉ EN CHINE

Wenn Sie Fragen haben, wenden Sie sich bitte an unser Kundendienstzentrum, Unsere Kontaktdaten stehen unten:

DE

 0049-0(40)-87408465

 service@aosom.de

ADRESSE DES IMPORTEURE/Hersteller/REP:
MH Handel GmbH
Wendenstraße 309
D-20537 Hamburg
Germany
IN CHINA HERGESTELLT

In caso di dubbio, si prega di contattare il nostro centro assistenza clienti, I nostri dettagli di contatto sono di seguito:

IT

 0039-0249471447

 clienti@aosom.it

IMPORTATO DA/Produttore/REP:
AOSOM Italy srl
Centro Direzionale Milanofiori
Strada 1 Palazzo F1
20057 Assago (MI)
P.I.: 08567220960
FATTO IN CINA

Si tiene alguna pregunta, comuníquese con nuestro Centro de Atención al Cliente, Nuestros datos de contacto son los siguientes:

ES

 0034-931294512

 atencioncliente@aosom.es

IMPORTADOR/Fabricante/REP:
SPANISH AOSOM, S.L.
C/ROC GROS, N°15.08550, ELS HOSTALETES DE
BALENYÀ, SPAIN.
B66295775
HECHO EN CHINA

Se tiver alguma dúvida, por favor contacte o nosso Centro de Atendimento ao Cliente, Os nossos dados de contacto são os seguintes:

 0034-931294512

 info@aosom.pt.

IMPORTADOR/Fabricante/REP:
SPANISH AOSOM, S.L.
C.ROC GROS N.15, 08550. ELS HOSTALETES DE
BALENYÀ
FEITO NA CHINA



FR

**DONNEZ
OU
RECYCLEZ**



ASSOCIATION

OU



LIVRAISON

OU



DÉCHÈTERIE

Adresses sur quefairedemesdechets.fr