

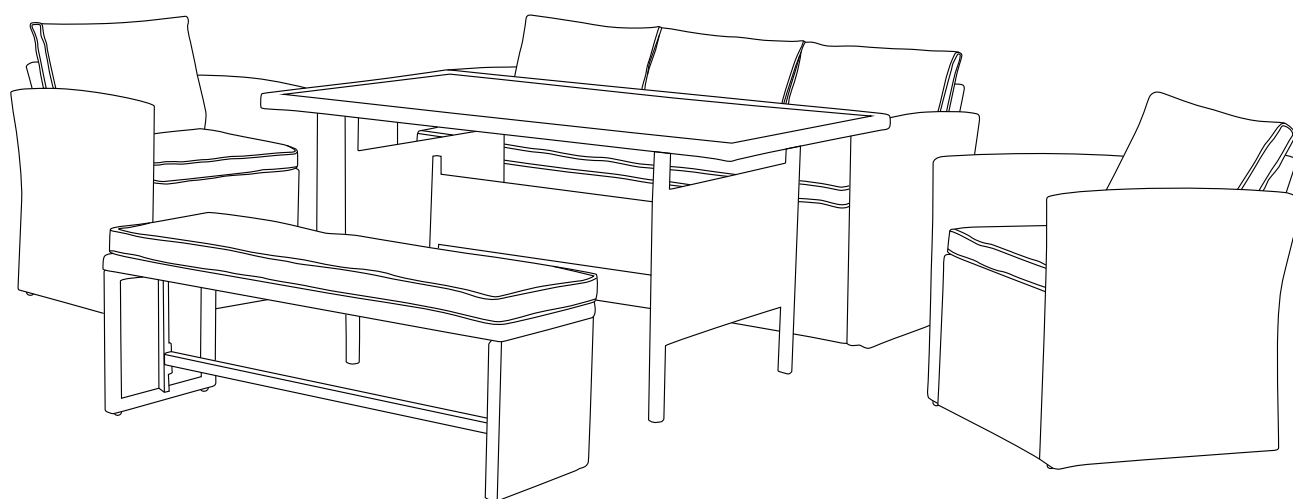





# ASSEMBLY INSTRUCTIONS





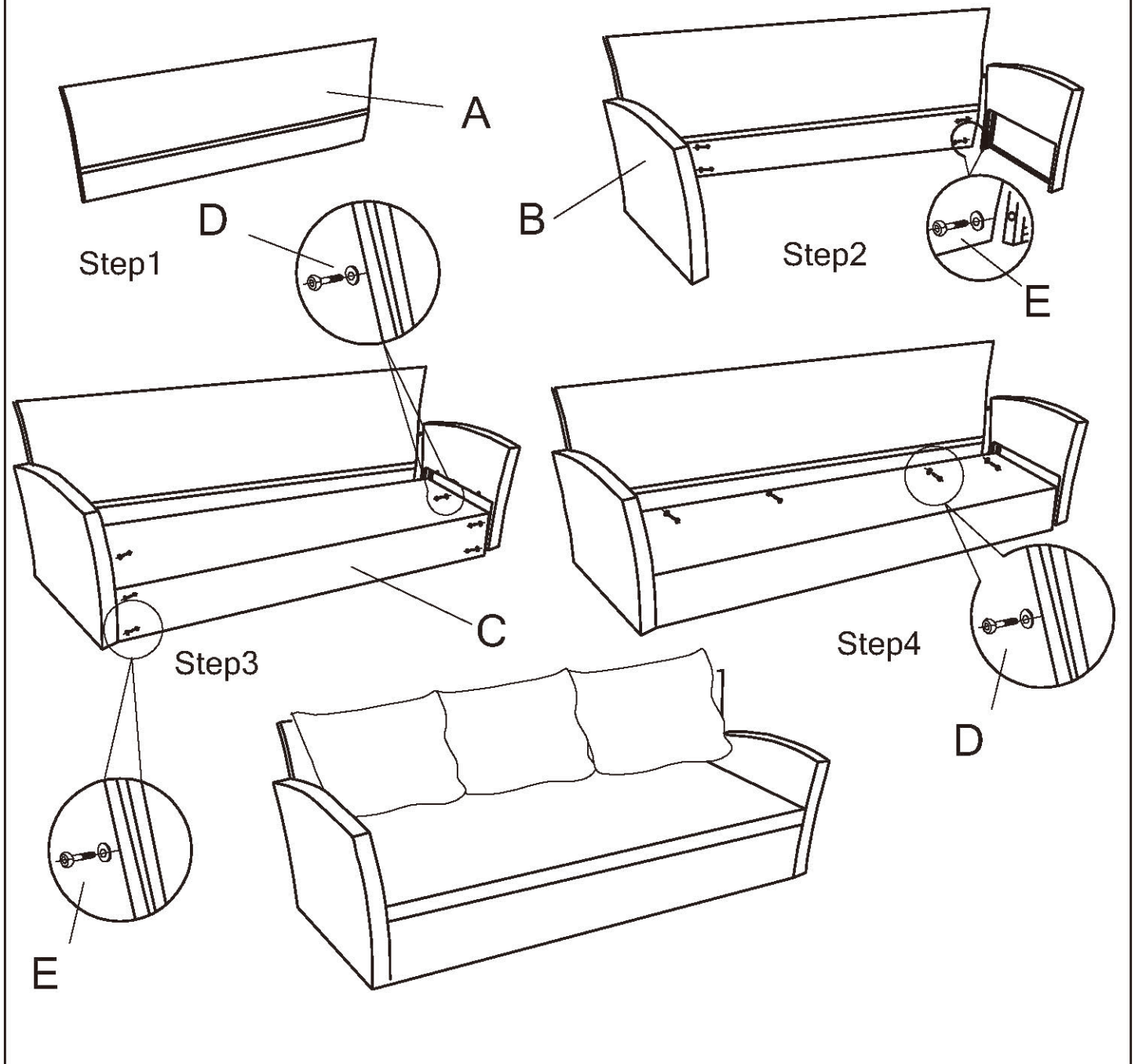

Do not fully tighten bolts until assembly is complete.

A		SOFA BACKREST	1 PC	B		SOFA ARMREST	2PCS
C		SOFA SEAT	1 PC	D		M6*40 BOLT/WASHER	6PCS
E		M6*35 BOLT/WASHER	8PCS				
G		ALLEN WRENCH	1 PC				

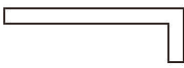

Do not fully tighten bolts until assembly is complete.

A		CHAIR BACKREST	2 PCS	B		CHAIR ARMREST	4PCS
C		CHAIR SEAT	2 PCS	D		M6*40 BOLT/WASHER	8 PCS
E		M6*35 BOLT/WASHER	16PCS				
G		ALLEN WRENCH	1 PC				

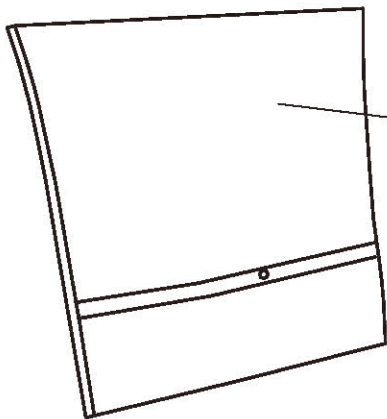

Step1

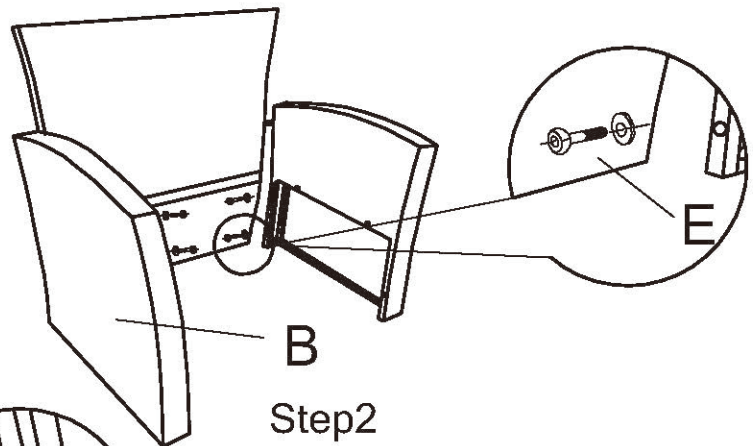

Step2

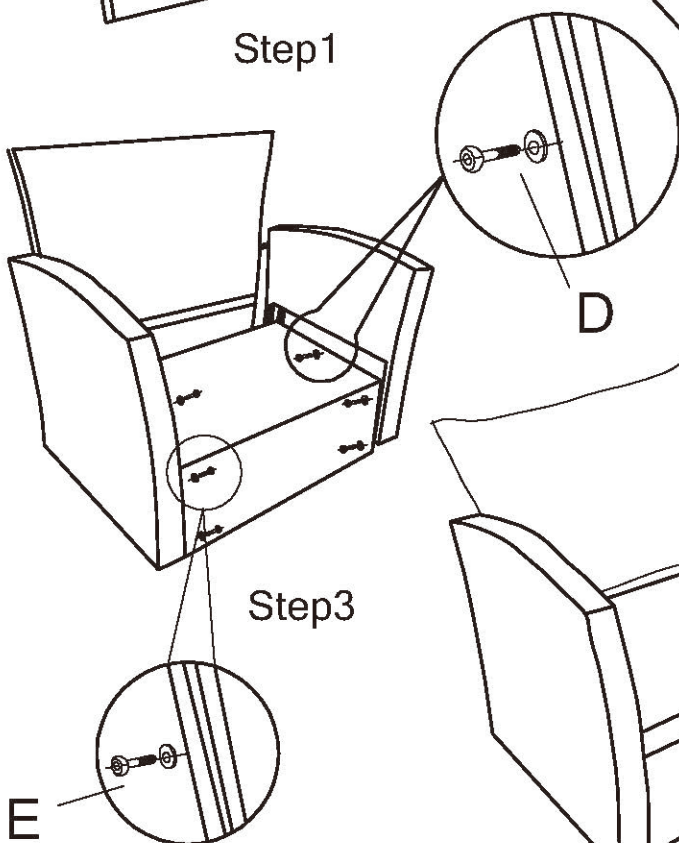



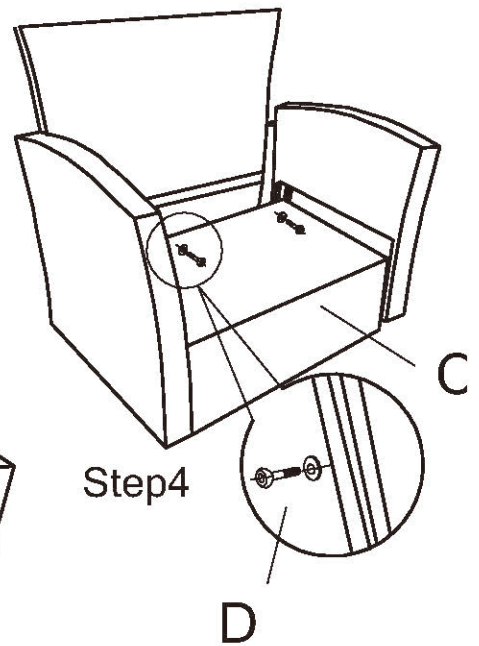

Step3

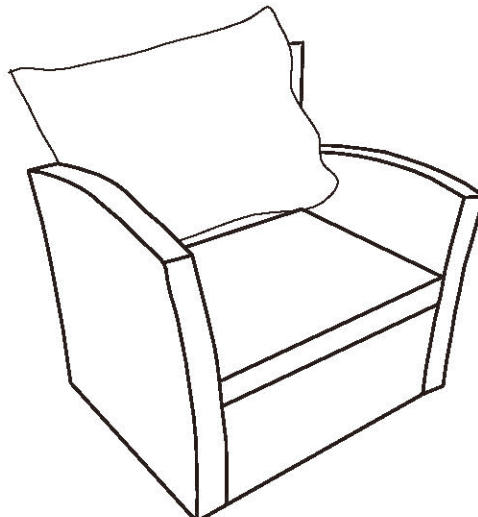

Step4

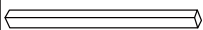
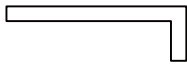

Do not fully tighten bolts until assembly is complete.

M		SEAT PANEL	1PC	L		Leg	2PCS
N		CONNEVTION BAR	1PC	G		ALLEN WRENCH	1 PC
E		M6x35mm BOLT/WASHER	4PCS				
O		M6x20mm BOLT/WASHER	4PCS				

### Step1

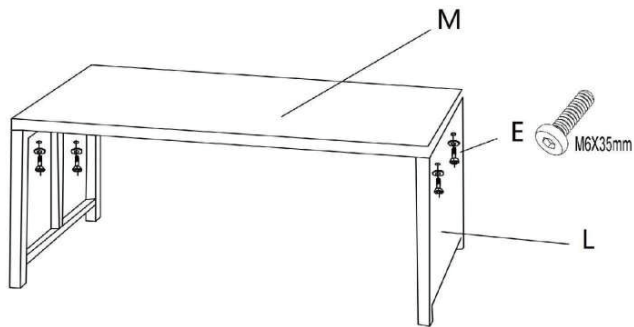



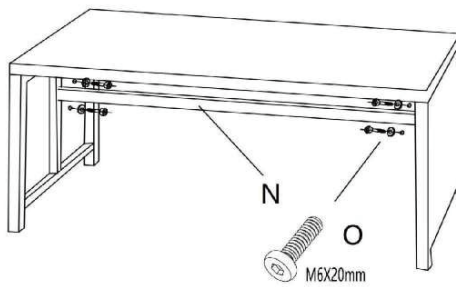

### Step2

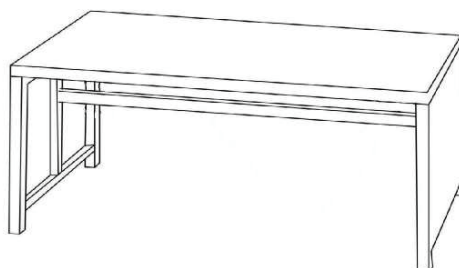

### Step3

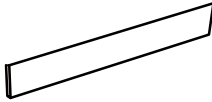

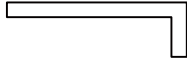
Do not fully tighten bolts until assembly is complete.

<b>A</b>		TABLE LEG	2 PCS	<b>B</b>		TABLE LINKER	2 PCS
<b>C</b>		TABLE TOP	1 PC	<b>D</b>		M6x20 BOLT/WASHER	4PCS
<b>E</b>		ALLEN WRENCH	1 PC	<b>F</b>		TABLE GLASS	1 PC
<b>G</b>		M6X30 BOLT/WASHER	4PCS				

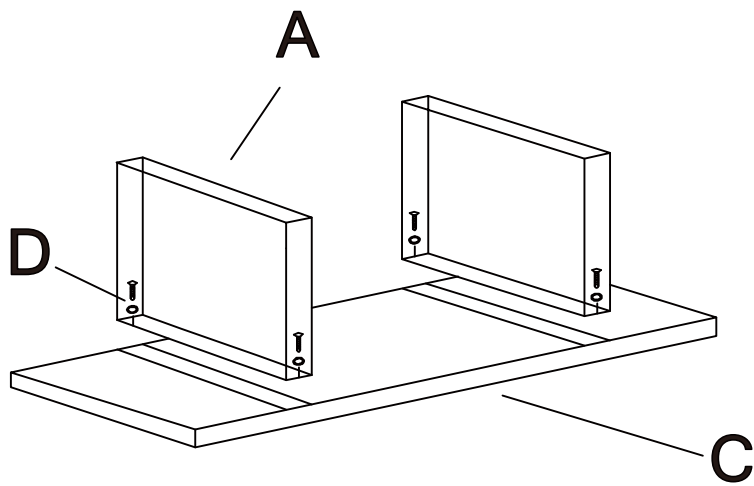

Step1

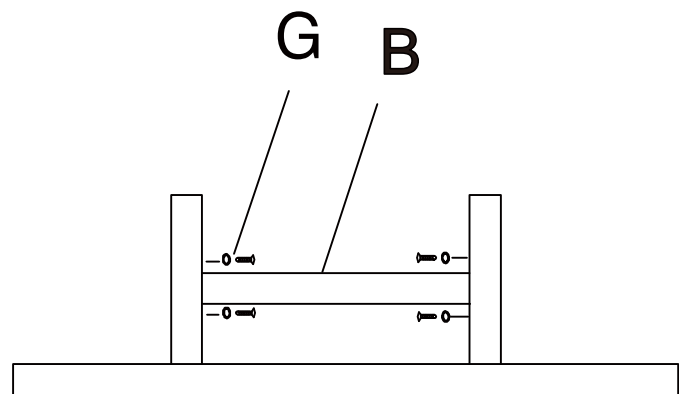

Step2